

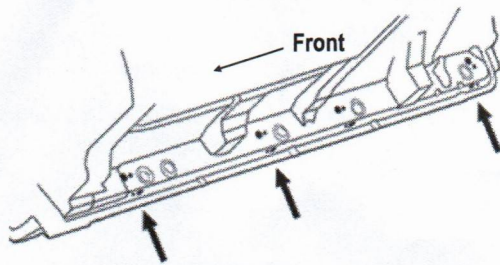

STEP 1

Start the installation under the passenger side of the vehicle. Locate the 3 factory running board mounting locations along the bottom and inner side of the body, **(Fig1)**. Mounting Brackets will bolt to the 1st, 2nd and 4th mounting locations.



(Fig 1) Passenger Side Mounting Locations Along Bottom And Back Of Body Panel Illustrated

STEP 2

Remove rubber plugs as necessary from the holes in the side and bottom of the inner body panel, **(Fig 2)**. Select (1) M8 Clip Nut. Slide the M8 Clip Nut into the large hole and over the smaller hole next to it in the side of the body panel. Line up threaded nut on the M8 Clip Nut with smaller hole in body panel, **(Fig 3)**. Repeat to install a M8 Clip Nut in the bottom mounting location.

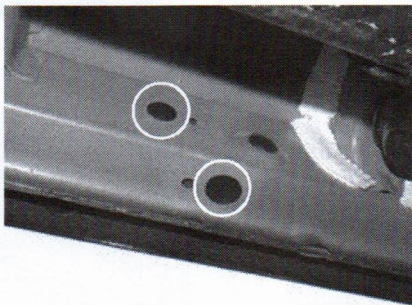

(Fig 2) Remove Plugs From Mounting Locations As Necessary

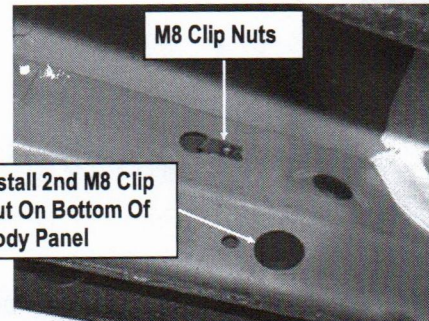

(Fig 3) Slide M8 Clip Nut Into Large Hole And Over Small Hole

STEP 3

Select (1) Passenger Front Mounting Bracket. Bolt the Passenger Front Mounting Bracket to the (2) installed M8 Clip Nuts with (2) M8X1.25-25mm Hex Bolts, (2) M8 Lock Washers and (2) M8 Large Flat Washers, **(Fig 4)**. Snug but do not fully tighten the hardware.

Note: All Mounting Brackets are universal.

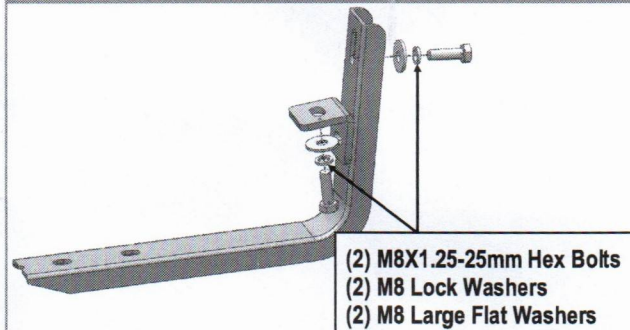

(Fig 4) Passenger Front Mounting Bracket Installation

STEP 4

Repeat **Steps 2-3** to install the remaining Passenger Center and Rear Mounting Brackets. do not fully tighten the hardware at this time.



STEP 5

Once all (3) Passenger side mounting brackets are installed, then proceed to the Step Bar installation. **(Figs 5 & 6)**

- (1) Select (1) Slider and (2) M8X1.25-35mm Carriage Bolts;
- (2) Install (2) M8X1.25-35mm Carriage Bolts in (1) Slider.
- (3) Slide the Slider (with carriage bolts) to the **Step Bar**.
- (4) Repeat to install the other (2) sliders to the step bar.
- (5) Attach the Step Bar (with the Sliders) onto the installed mounting brackets. Position the Sliders to the installed brackets. Secure the Step Bar to the installed Brackets by using (6) M8 Large Flat Washers and (6) M8 Nylon Lock Nuts and (3) Sliders, **(Fig 6)**. Do not fully tighten hardware at this time.

Note: The Sliders are packed with the Step Bars.

Level and adjust the Step Bar and fully tighten all hardware.

Repeat **Steps 1-4** for the other side Step Bar installation. **The installation is completed!!!**

Attention

Do periodic inspections to the installation to make sure that all hardware is secure and tight.



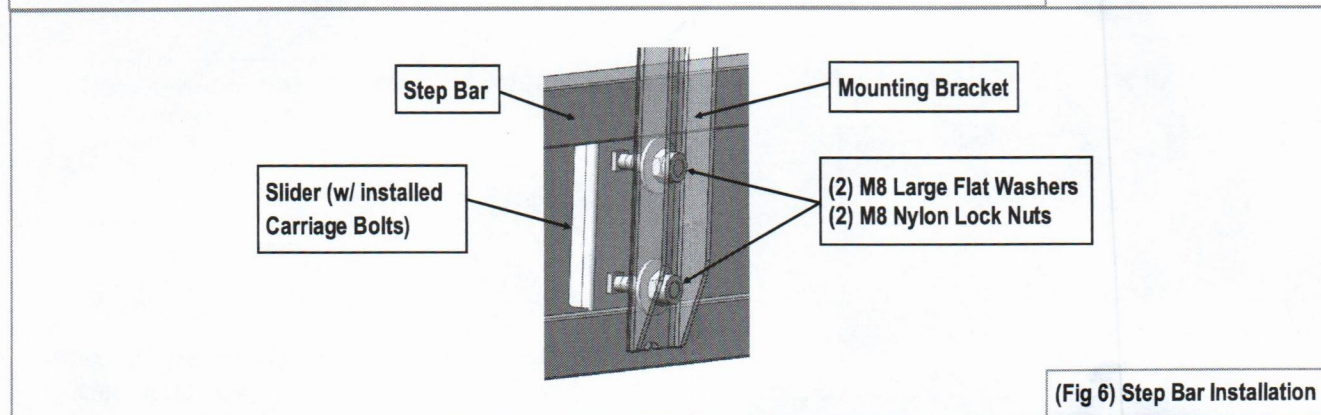
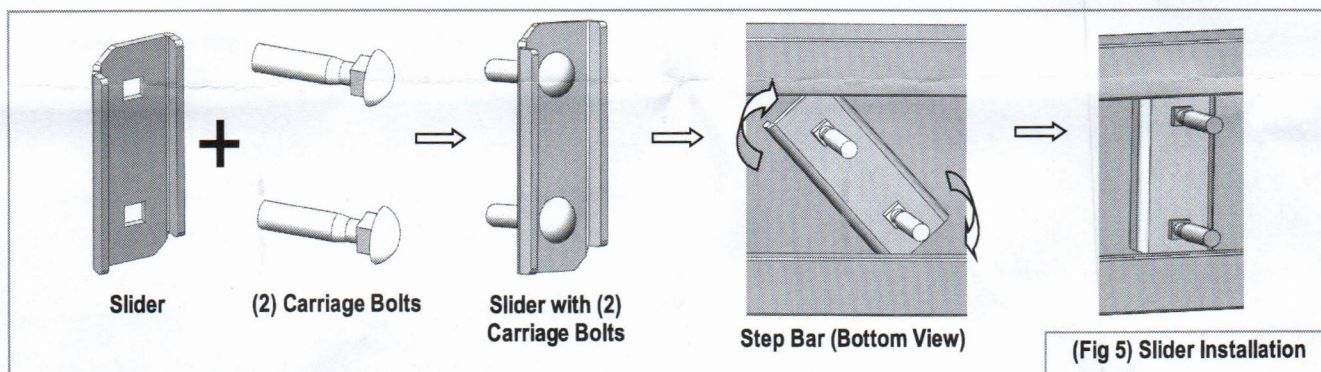

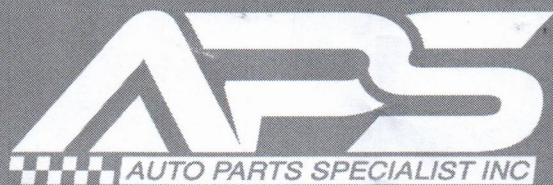
In order to protect your bars/boards, please use mild soap/non-abrasive products for cleaning only.









Scan for
Installation Video

| Mounting Bracket List | | | | | |
|-----------------------|-----|-------------------|------|-----|-------------|
| Item | QTY | Description | Item | QTY | Description |
| 1# | 6 | Mounting Brackets | | | |

| Hardware Package A (For Bracket Installation) | | | | | |
|--------------------------------------------------------------------------------------------------------------------------------------------------------------------------------------------------------------------------------------------------------------------------------------------------------------------------------------------|-----|------------------------|------|-----|-----------------|
| Item | QTY | Description | Item | QTY | Description |
| 1# | 12 | M8X1.25-25mm Hex Bolts | 3# | 12 | M8 Lock Washers |
| 2# | 12 | M8 Large Flat Washers | 4# | 12 | M8 Clip Nuts |
|     | | | | | |
| 1 # 2 # 3 # 4 # | | | | | |

| Hardware Package B (For Stainless Steel Step Bar Installation) | | | | | |
|----------------------------------------------------------------------------------------------------------------------------------------------------------------------------------------------------------------------------------------------------------------------------------------------------------------------------------------------------|-----|-----------------------------|------|-----|---------------------------------|
| Item | QTY | Description | Item | QTY | Description |
| 1# | 12 | M8X1.25-35mm Carriage Bolts | 3# | 12 | M8 Nylon Lock Nuts |
| 2# | 12 | M8 Large Flat Washers | 4# | 6 | Sliders (Packed with Step Bars) |
|     | | | | | |
| 1 # 2 # 3 # 4 # | | | | | |

Customer Support: info@iboardauto.com



Scan for
Installation Video

PART#: IB-197C&H

iBoard® Series

READ INSTRUCTIONS CAREFULLY BEFORE START ING
INSTALLATION. REMOVE CONTENTS FROM BOX AND
VERIFY ALL PARTS ARE PRESENT. ASSISTANCE IS
RECOMMENDED.

*ROCKER PANEL MOUNT
*NO DRILLING REQUIRED

| Fastener Size | Tightening Torque (ft-lbs) | Required |
|---------------|----------------------------|----------|
| 6mm | 6-7 | X |
| 8mm | 16-18 | √ |
| 10mm | 31-32 | X |
| 12mm | 56-58 | X |
| 14mm | 92-94 | X |

PART LIST

Driver Side Step Bar

Front
↑

Passenger Side Step Bar

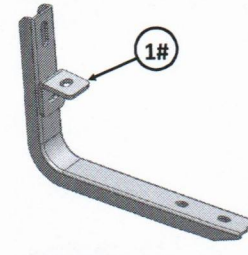
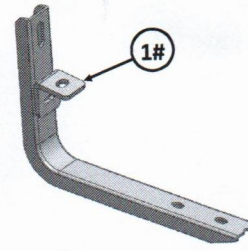
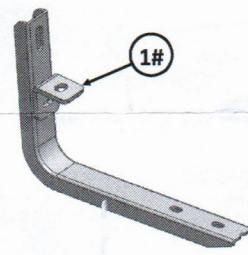
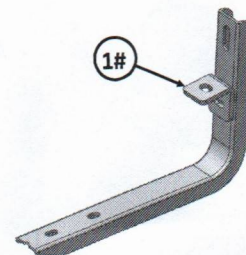
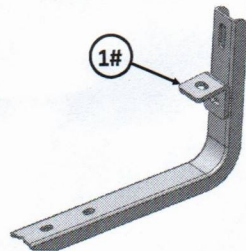
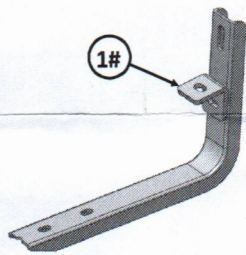

Customer Support: info@iboardauto.com