



**DOWNLOAD THE LATEST
INSTALL MANUALS AT
www.bddiesel.com**



47RE/48RE BD Valve Body

For 1996-2007 Dodge 5.9L Cummins Trucks





1030416	1996-1998 Dodge 12-valve (47RE)
1030416E	1996-1998 Dodge 12-valve (47RE) w/ Solenoid
1030418	1998½-2002 Dodge 24-valve (47RE)
1030418E	1998½-2002 Dodge 24-valve (47RE) w/ Solenoid and transducer
1030423	2003-2007 Dodge CR (47RE/48RE)
1030423E	2003-2007 Dodge CR (47RE/48RE) w/ Solenoid and transducer
1030423ET	2003-2007 Dodge CR (47RE/48RE) Tap Shift Ready w/ Solenoid and transducer

NOTE Diode/Resistor installation is NOT required on 2005-2007 trucks, and also not required on 2000-2004 trucks that use the transducer adapter included in 1030418E, 1030423E and 1030423ET.





See Instruction manual **I-00474** for manual valve body applications.

Kit Contents

	1600050	1030498	1030401
			
Valve Body	Front Servo Spring	Front Band Strut	E-clip Tool
Qty: 1	Qty: 1	Qty: 1	Qty: 1

4617216	22170	12776	12776J
			
Gov Housing Gasket	Transmission Pan Gasket	Trans Filter (1030416(E) only)	Trans Filter (1030418(E) & 1030423(E)/(ET))
Qty: 1	Qty: 1	Qty: 1	Qty: 1

Overpressure Diode Installation Parts (do not install on 2005-2007 or 2000+ "E" kits)

1600129	1210353	1330159	1300131
			
Diode	Butt Connector	Heat Shrink	Tie Wrap
Qty: 1	Qty: 2	Qty: 3.5"	Qty: 2

This part is only included in 1030418 and 1030423:

6595

Orifice Plug for Plastic Transducer
Qty: 1

Table of Contents

- Kit Contents 2
- Table of Contents..... 3
- Optional Items..... 3
- Introduction 4
- Tools Required 4
- Additional Parts Required (Not included) 4
- Pre-Installation..... 4
 - Initial Pressure/Shift Testing 4
- Installation..... 6
 - Valve Body Removal..... 6
 - Band Strut and Servo Upgrade 9
 - Remove Electronics from Old Valve Body 13
 - Electronics Upgrades/Modifications 14
 - 1996-2004 Diode Installation(1030416/1030416E/1030418/1030423)..... 14
 - 2000-2007 Plastic Transducer Restrictor (1030418/1030423) 15
 - 2000-2007 Transducer Upgrade Installation (1030418E/1030423E)..... 15
 - Transfer Parts to New Valve Body 16
 - Valve Body Installation..... 17
 - Throttle Valve Adjustment/Initialization 22
 - Throttle Cable Adjustment (1996-2004) 22
 - TTVA Motor Re-Initialization (2005-2007) 22
 - Gear Shift Cable Adjustment (2003-2007) 23
 - Road Test and Verification..... 23
- Before you call Tech Support..... 24
- Questions?..... 24

Optional Items



BD Trans Pan
(1989-2007)
1061501



HD Governor
Solenoid
4617213



2000+ Electronics
Upgrade
1060605

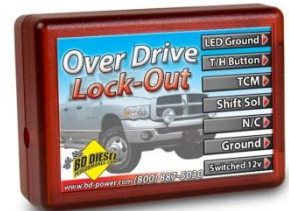

2005 Overdrive
Disable
1031350

Introduction

BD's 47RE and 48RE valve bodies incorporate a number of improvements over the stock unit which both improve shifting but also increase the transmissions power holding capability.

These valve bodies have increased line pressure for better clutch holding, increased torque converter cooling flow, an upgraded boost valve retainer, a custom BD separator plate that along with our other modifications provides improved shift quality and the ability to engage lockup in 1st and 2nd gears.

This kit also includes two additional parts which we have found to be weak links that can easily be addressed at this time; a billet second gear band strut and a stronger second gear servo return spring, designed to work best with our valve body.

BD Tap Shift Ready valve bodies are compatible with BD Tap Shifter electronic kits.

Tools Required

- Inch Pound Torque Wrench
- Socket sets including 7/16" , 1/2" & 1-5/16" sockets
- T25 Torx Bit or screwdriver
- T40 Torx Bit
- Combination Wrench Set including 7/16" & 3/4"
- High quality pressure gauge (0-300psi)
- 6" C-clamp

Additional Parts Required (Not included)

- Mopar ATF+4
- 1 Bottle of Red Lube Guard (recommended)

Pre-Installation

Before starting make sure you have read all of the instructions to ensure you are equipped for the job. Inspect the valve body and all components shipped to you to ensure no parts are missing or damaged. Confirm the part number ordered is the correct one for your truck.

If you are installing a TapShift Ready valve body, ensure you have the TapShifter instruction manual handy.

Initial Pressure/Shift Testing

Transmission line pressure should be tested prior to engine or transmission performance modifications to confirm the transmissions capability to prevent clutch slipping. Slippage will result in premature converter and transmission wear (soft or hard shifting, high temperatures). Check transmission fluid level before these tests.

Install a pressure gauge and hose into the center 1/8”NPT port on the passenger side of the transmission (3), route the hose into the cab for viewing.

This is the accumulator test port and will only show pressure when the vehicle is in drive.

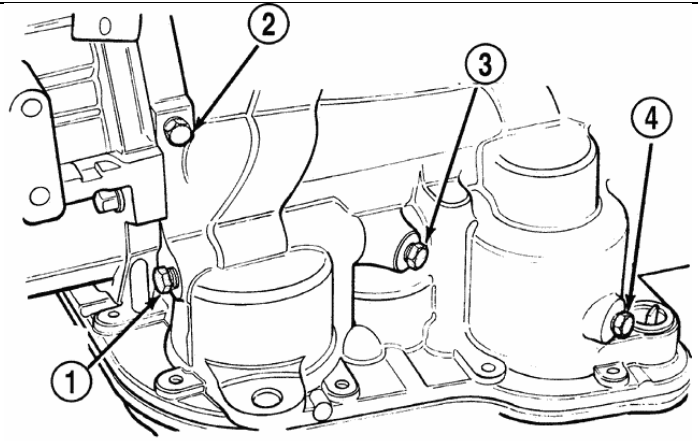

Road test the vehicle and record the pressures and shift point RPMs BEFORE modifications are carried out to confirm condition of transmission prior to installing this valve body. Pressure readings are to be taken in DRIVE.



48RE Transmissions				
Transmission Line Pressure	OEM Pressure	BD Pressure	Test #1	Test #2
Transmission in DRIVE w/Engine at idle	55-65psi	90-110psi		
Transmission in DRIVE w/Convertor Locked up @ WOT	110-120psi	170-200psi		

Transmission Shift Points		
Transmission Shift Point (RPM)	Before	After
2 nd – 3 rd Shift point (Normal Driving)		
2 nd – 3 rd Shift point (Wide Open Throttle)		

IMPORTANT If pressures or shift points are not to specs, the transmission must be repaired or serviced before modifications.

Installation

Valve Body Removal

Lift the truck on a vehicle hoist or with appropriate jack stands.

2005-2007 - remove the two TTVA motor bolts from the transmission.

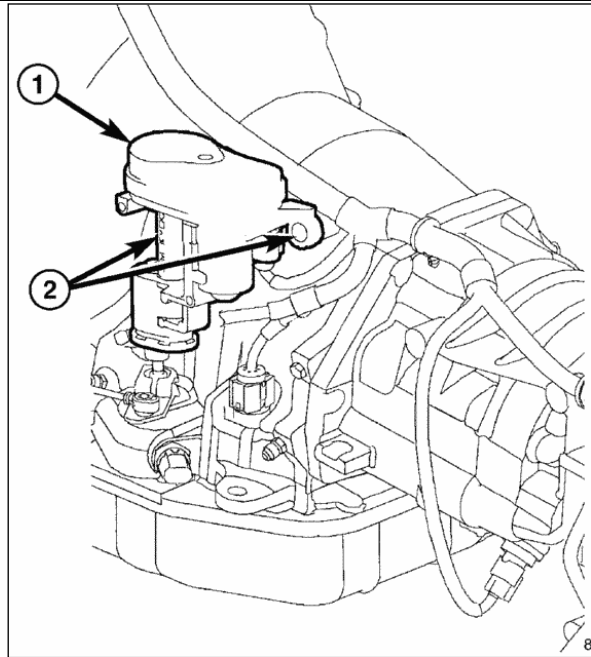

2005-2007 – allow TTVA motor to swing out. Lift it off the throttle valve shaft and unplug the electrical connector. Place to the side.

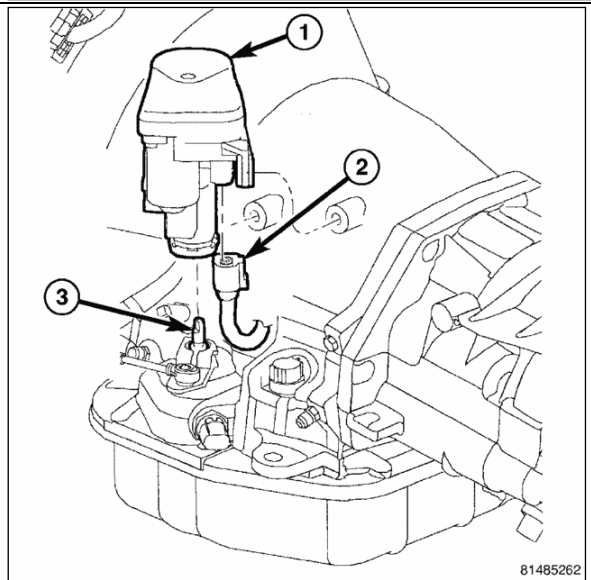

1996-2004 – Unclip the throttle valve cable from the lever. Unhook the throttle valve return spring from the bracket and the lever.



On trucks equipped with a shift cable, pop the end off of the shift lever.



On trucks equipped with a shifter rod linkage, remove the linkage from the transmission lever.

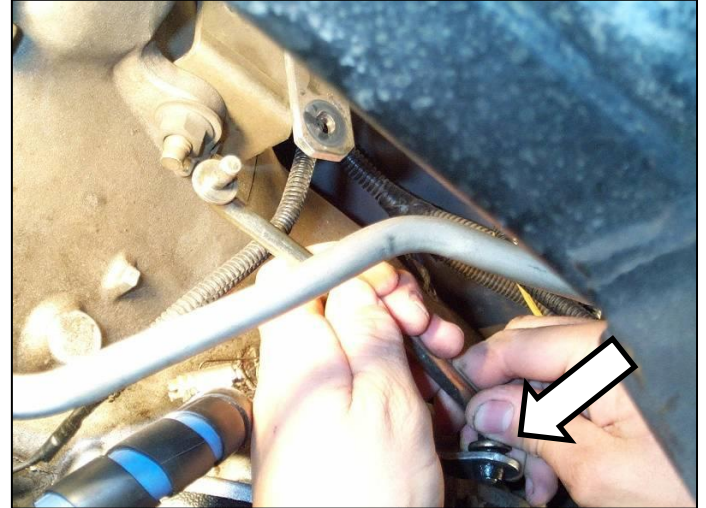

1996-2004 – Loosen the pinch bolt on the throttle valve lever and remove it from the transmission.



Rotate the shift lever to the front of the vehicle to put the transmission in LOW/1st. This will make E-clip removal easier.

Loosen the shift lever pinch bolt and remove from the transmission.

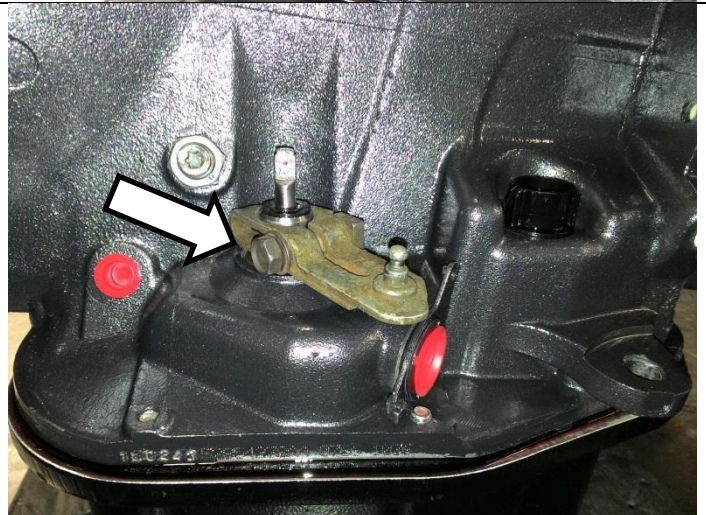

Disconnect the vehicle wiring harness (1) from the transmission by unplugging the round 8 pin electrical connector.

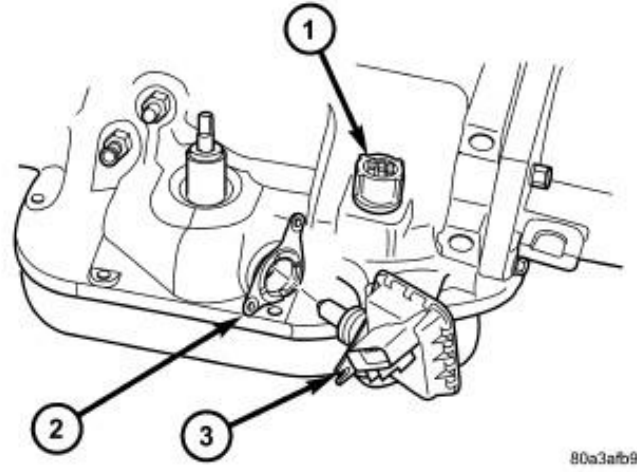

2003-2007 – Unplug the black connector from the PRNDL sensor. Remove the two Torx screws and pull the sensor out of the transmission.

NOTE Some fluid may drain out, so place a drain pan below.



1996-2002 – Unplug the three-pin neutral safety switch and unscrew the switch from the transmission.

NOTE Some fluid may drain out, so place a drain pan below.



Place a large drain pan under the transmission. Remove the oil pan and drain the transmission fluid.

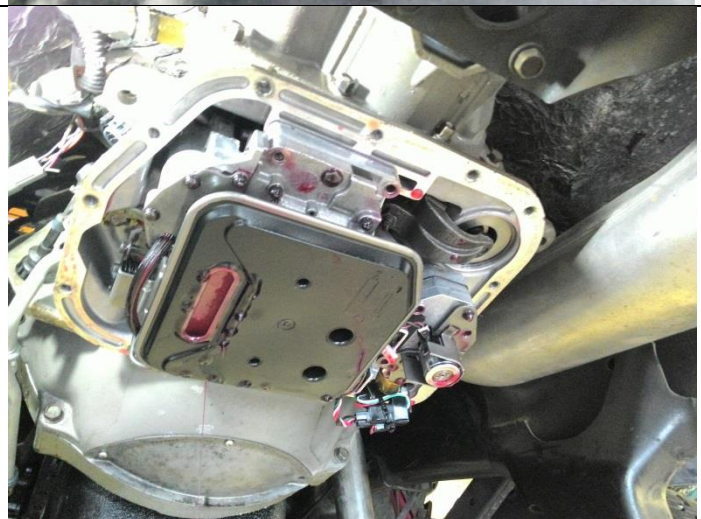

Carefully remove the E-clip from the park rod, leaving the park rod in the transmission.

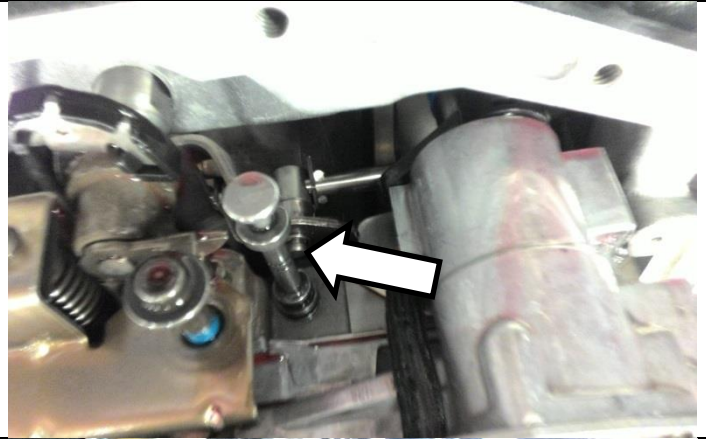

Remove the 10 valve body bolts.

Important The bolts are different lengths and are not all interchangeable, make note of their respective location for reassembly.

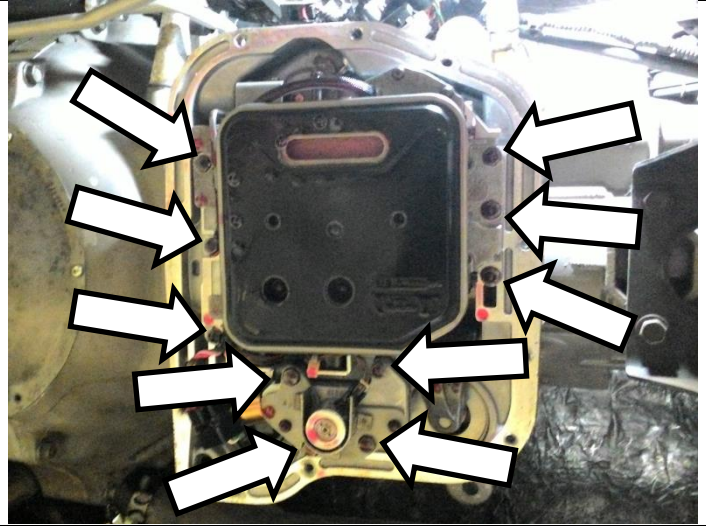

When lowering the valve body, gently work it out to ensure the electrical plug is not damaged and that the transmission park rod remains in the transmission.

Note As you lower the valve body, the accumulator spring and piston may fall out from above the governor housing. Use care to keep them from being lost or damaged.

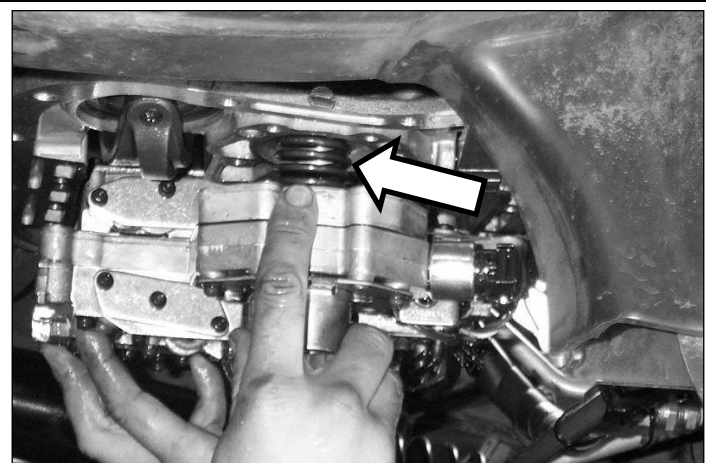

Band Strut and Servo Upgrade

Loosen the band adjusting screw lock nut on the outside of the transmission case with a 3/4" wrench. (This is located on the driver side, above the shift lever shaft).



Using a T40 Torx bit, loosen the adjuster screw until the stock band strut can be removed from the transmission.

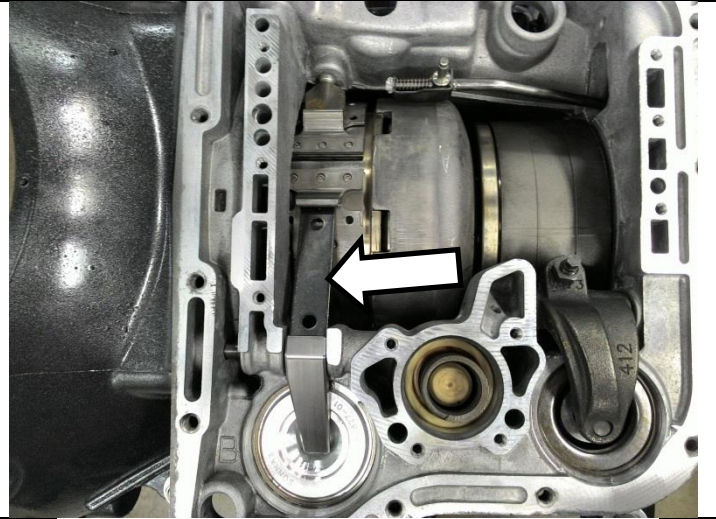

The next step involves installing the servo spring upgrade. This will require a 6" C-clamp and a 32mm or 1-5/16" socket to compress the servo.



Using the C-clamp and socket, compress the servo piston into the bore of the transmission.

Important! Do not scratch the servo bore. This could seriously damage the transmission. Ensure the clamp or socket do not contact the servo bore.



Using a small screwdriver or pick tool, remove the servo retaining clip.

Caution The retainer clip may spring out. Wear eye protection and do not lose the retainer.

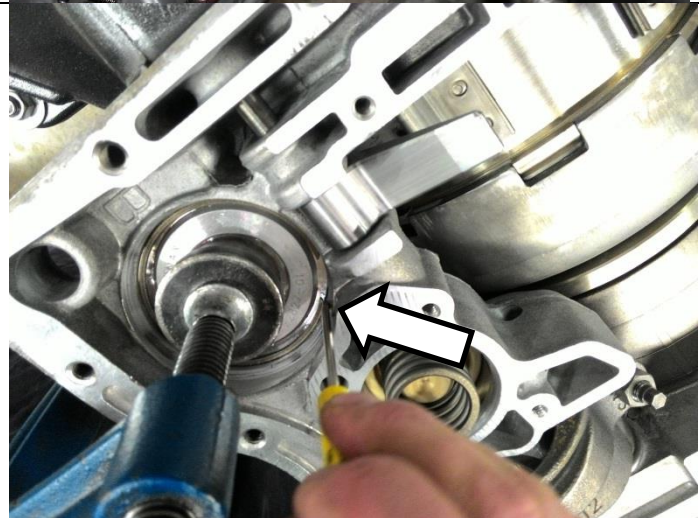

Loosen the C-clamp and allow the servo piston to come out of the transmission.

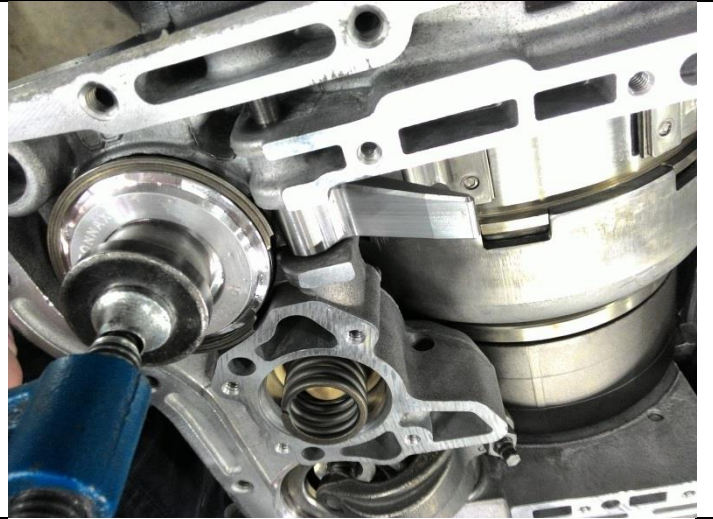

The original servo has a single spring. Add the new spring supplied in this valve body kit inside the original spring.



The servo assembly with both springs, ready to reinstall.



Reinstall the servo in the transmission using the C-clamp. Slowly and carefully install servo piston and use a small screwdriver to ensure the seal ring tucks in correctly and is not damaged. Compress far enough to reinstall the retainer.



Reinstall the retainer clip. Check it is fully seated in the groove. Remove the C-clamp.



Install the new BD band strut supplied in this kit. The tapered side should face outwards (towards the pan).

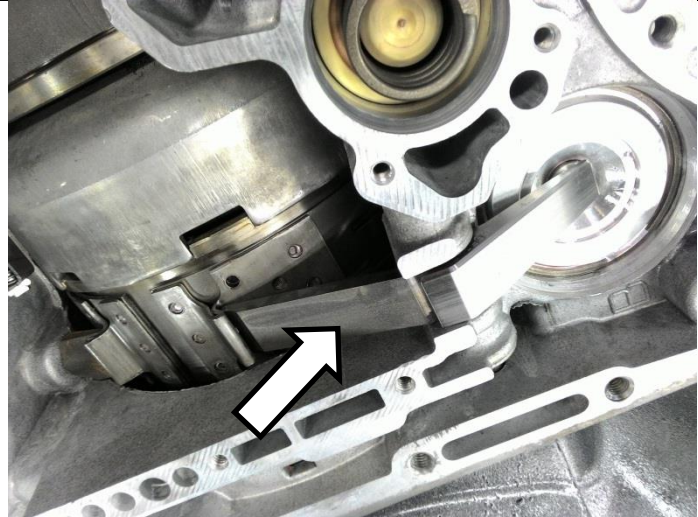

Set the 2nd gear band adjustment. Torque the T40 band adjuster screw to 72in-lb, then back out 2-1/4 turns. Tighten lock nut while keeping adjuster screw from turning.



To confirm adjustment, pull the servo lever outwards. The airgap should measure 5/16". The flattened end of the supplied E-clip installer can be used as a feeler for this measurement.



Remove Electronics from Old Valve Body

1030423ET TapShift VB

Refer to the instruction manual included with your Tap Shift electronics kit now for additional details on the following steps.

On the old valve body, remove the small Torx shoulder screw that holds the electrical connector to the valve body. This will get transferred to the new valve body.

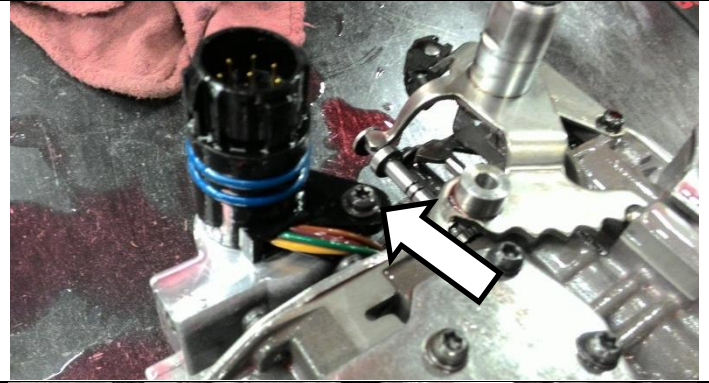

Flip over the valve body and remove the two Torx screws from the governor solenoid housing. This will allow the housing to come off of the valve body.

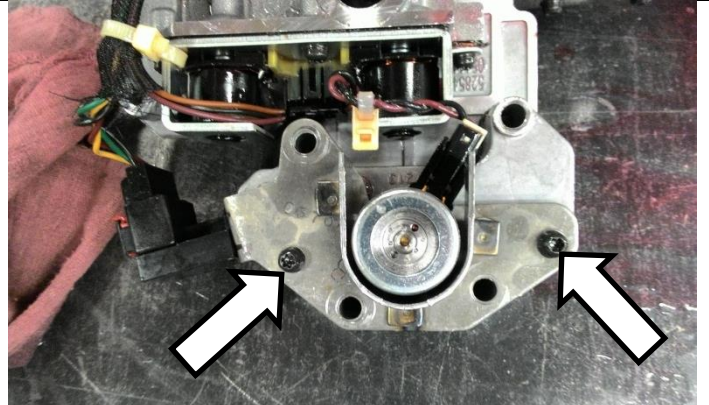

Remove the three short Torx screws holding the overdrive/TCC solenoids to the valve body.

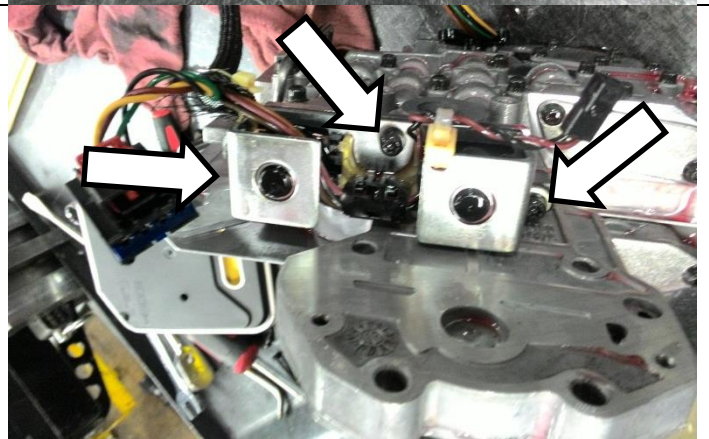

Electronics Upgrades/Modifications

1996-2004 Diode Installation(1030416/1030416E/1030418/1030423)

1996-2004 trucks without the transducer adapter will require a diode to be installed to prevent overpressure codes being set in the TCM.

2005-2007 trucks do **not** require this modification. 2000-2004 trucks using the BD transducer do **not** require this modification (1030418E/1030423E).



Pull back the braided sleeving on the transmission internal wiring harness to access the wires for modification.



Close to the 8 pin connector, cut the sensor ground wire (pin 3/green) and cut the sensor signal wire (pin 4/white). Slide the supplied heat shrink over both wires. Crimp the diode in with the stripe towards the white wire.

Note The white wire is often discolored to pink from the ATF.

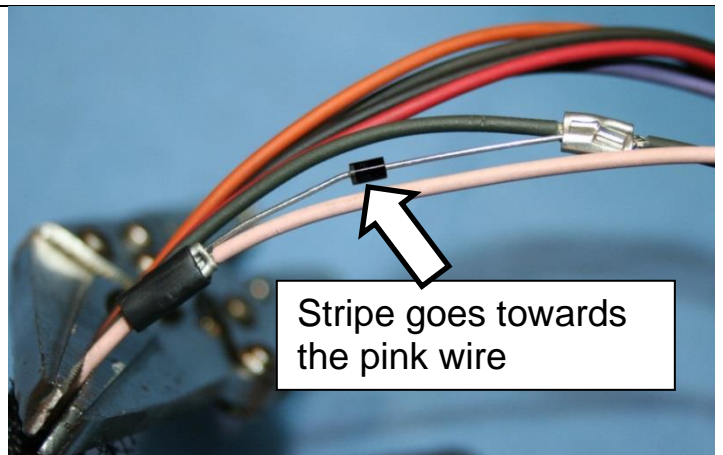

Slide the heat shrink back in place and shrink it over the connections to protect them. Slide the braided sleeve back over the wires.

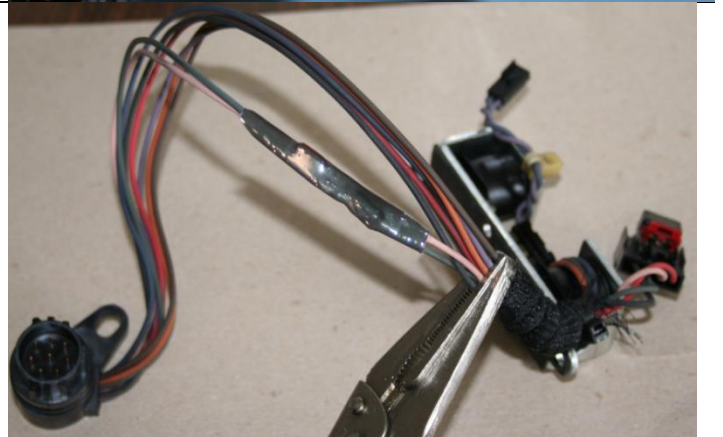

2000-2007 Plastic Transducer Restrictor (1030418/1030423)

2000-2007 If you are **not** installing the upgraded BD transducer a modification must be made to your plastic transducer.

(This is not required for 1030418E, 1030423E and 1030423ET which include an upgraded metal transducer)

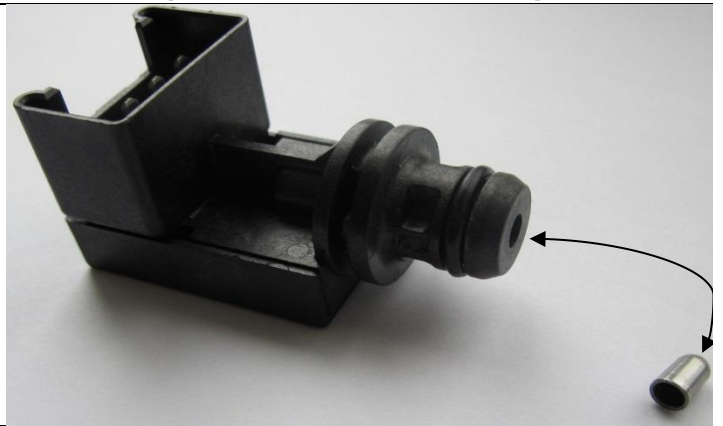

Locate the restrictor included in this kit. Carefully install it into the transducer by squeezing it in a vice as shown. **Do not use a hammer!**

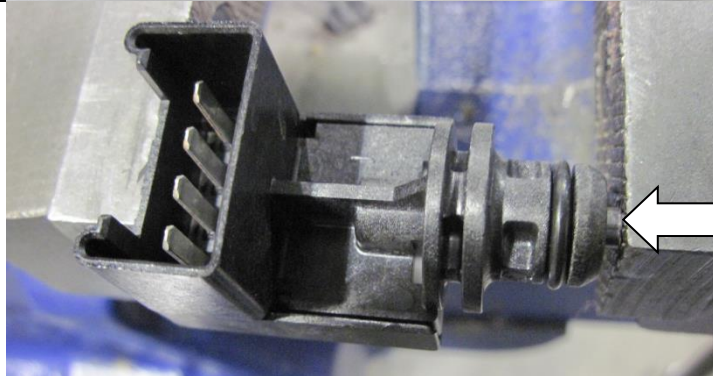

The intention of this restrictor is to prevent over pressure damage from rapid increases in pressure.

To avoid this modification use 1030418E/1030423E or purchase the upgrade separately.

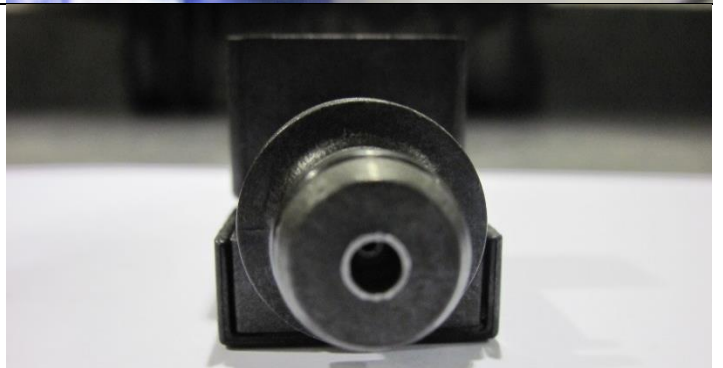

2000-2007 Transducer Upgrade Installation (1030418E/1030423E)

These two kits include the heavy duty transducer with the adapter required to use this transducer on your truck. Locate the transducer and the adapter supplied in your kit.



Follow the directions included in the transducer upgrade kit to connect the new transducer and pigtail and to make the modifications required to the original bracket.

(1996-1999 do not use the adapter)

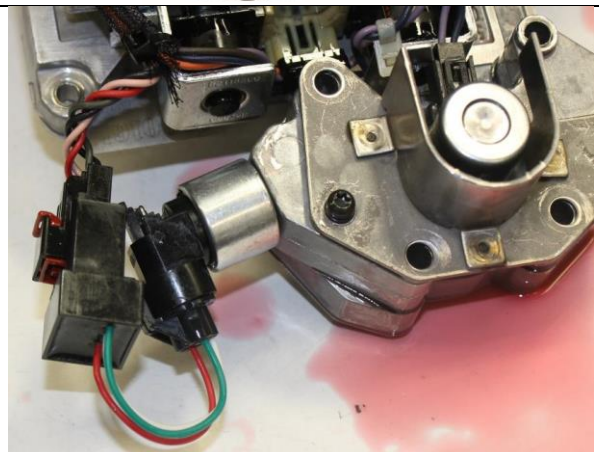

Transfer Parts to New Valve Body

Install your original OD/TCC solenoids to the new valve body by attaching it with the three small Torx screws removed earlier.

Torque to 50in-lb (4ft-lb)

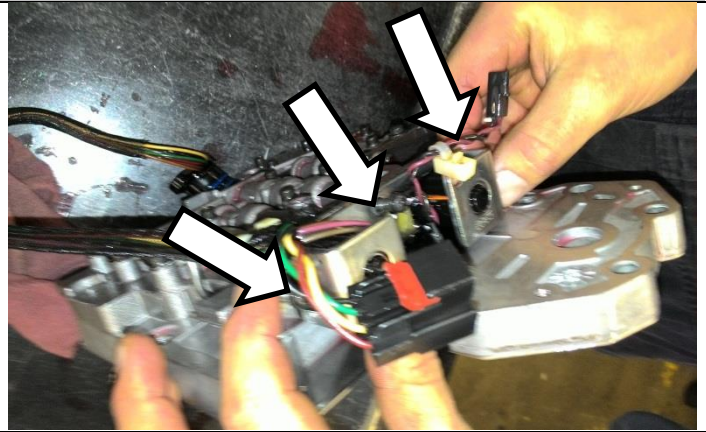

If you have purchased a 1030416E/1030418E/1030423E/1030423ET install the new HD solenoid and transducer supplied in the kit.

Note 1998½-1999 trucks with the 1030418E valve body will use the transducer but will discard the adapter; it is for 2000+ trucks only.

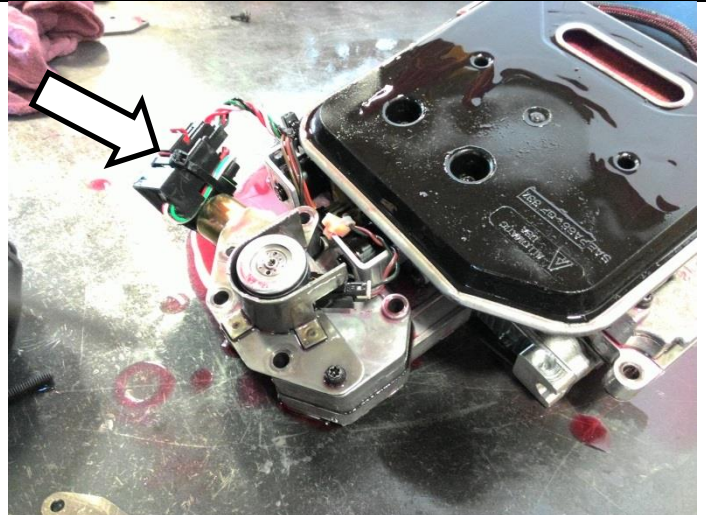

If you are transferring your old governor solenoid and pressure sensor, install the housing as removed from the old valve body with the two long Torx screws and plug in the two connectors. Torque to 50in-lb (4ft-lb).

Suggestion These two parts are high failure rate items. Now is a good time to upgrade with BD parts or purchase new OEM parts.

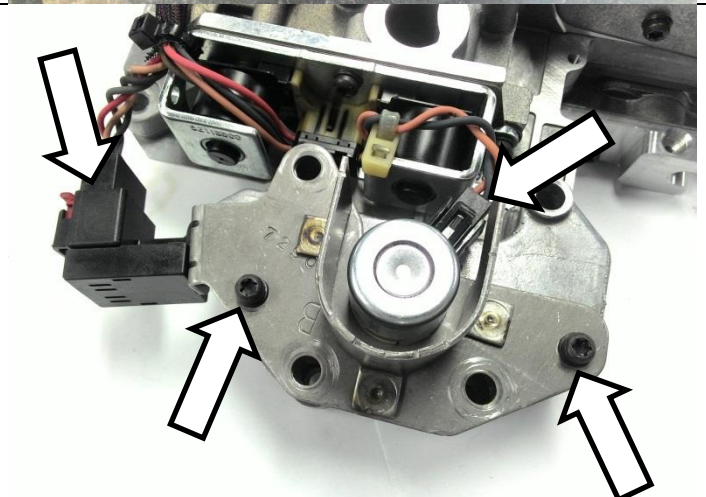

Route the solenoid wiring harness around the valve body. Route the wire through the holder shown.

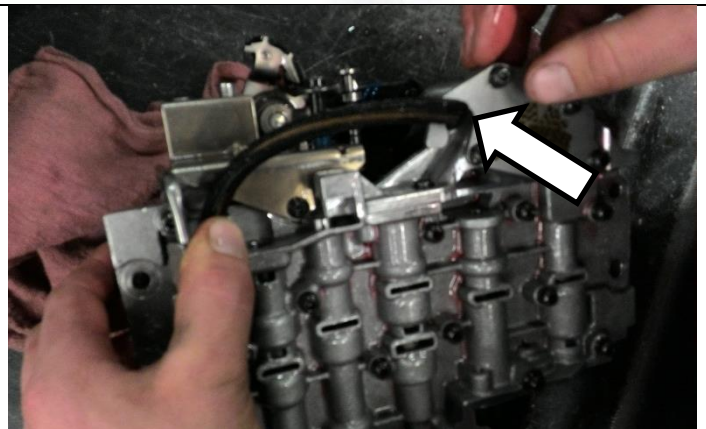

Install the solenoid wiring harness electrical connector using the special shoulder screw removed earlier. Ensure the locator nub on the bottom of the connector is engaged to the valve body for correct alignment.

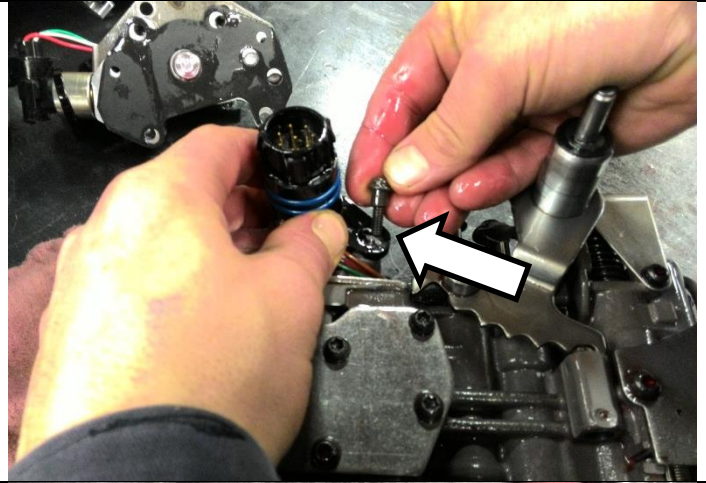

Install the new transmission filter supplied in this valve body kit. Reuse the long filter screws from your old valve body. Torque to 50in-lb (4ft-lb).

Note Early model filter has three screws rather than two.

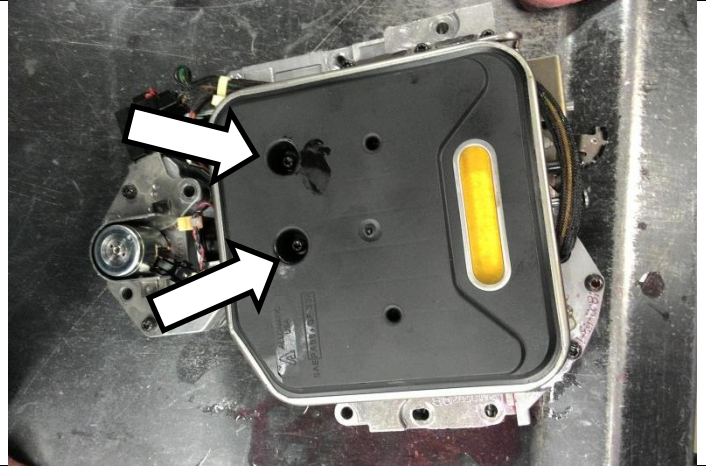

Valve Body Installation

Now that the valve body is fully assembled, it is time to install it in the transmission.

The accumulator piston and spring need to be reinstalled with the valve body. If you cannot balance these parts on the valve body, hold them in place with a supporting tool or wire until the valve body is installed.

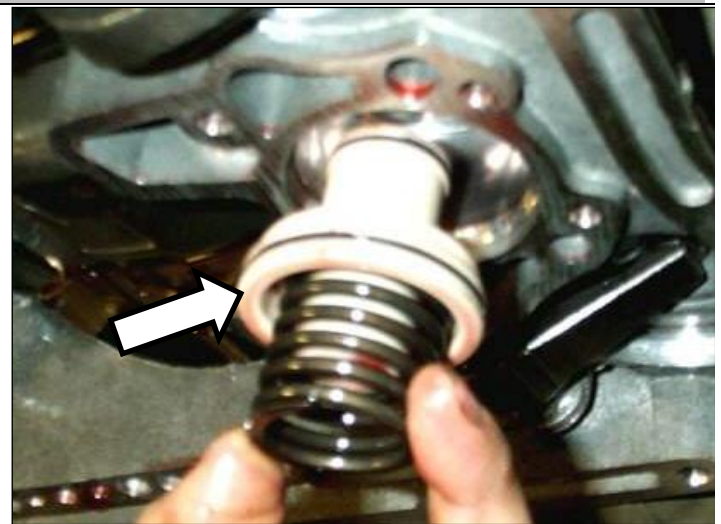

Lubricate the manual shaft seal and electrical connector seal with ATF. Lift the valve body into the transmission. Line up and install the park rod into the manual shift lever. Hold the valve body in place with a couple of bolts.

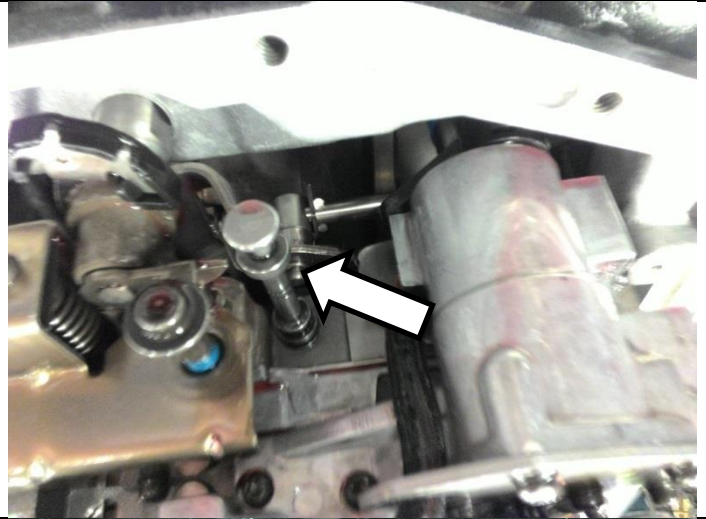

Install the E-clip on the park rod using the supplied E-clip installation tool.



Install the rest of the valve body bolts. There are different lengths, be sure they go in the correct places.

Torque all valve body bolts to 120 in-lb (10ft-lb)



1030423ET TapShift VB Only

Install the supplied metal bracket that is supplied with the valve body to support the steel tube to keep it from vibrating. Install the steel bracket under one of the valve body bolts as shown.

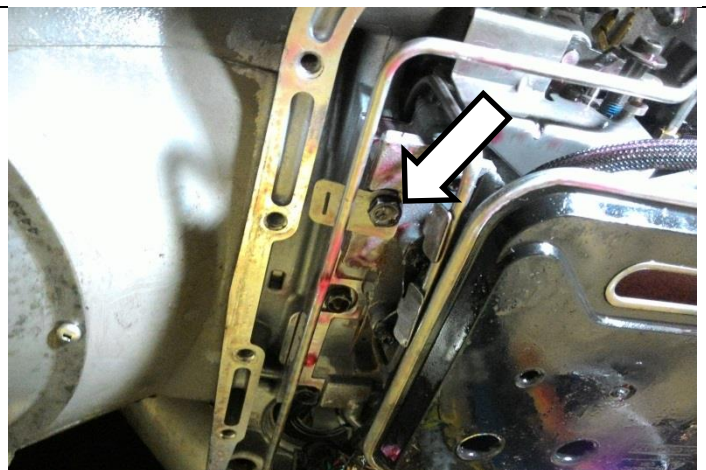

1030423ET TapShift VB Only

Then bend the bracket around the line and using a small hammer tap it so that it tightly holds the steel line.

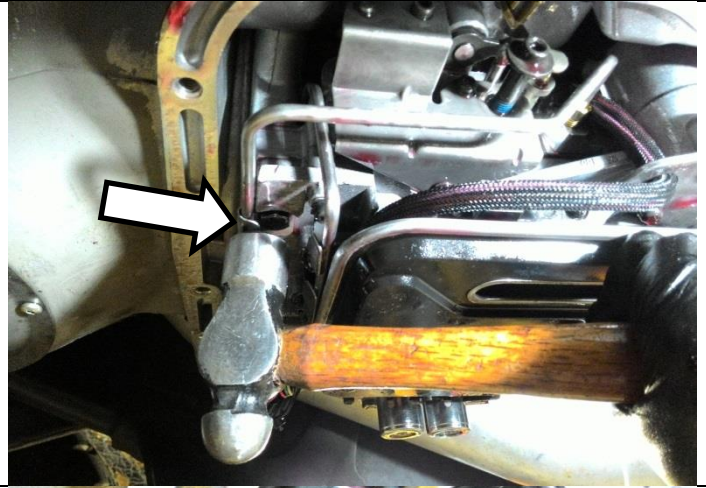

1030423ET TapShift VB Only

Bracket shown installed.

IMPORTANT Not installing this bracket on the TapShift valve bodies may cause premature fatigue failure of this line.

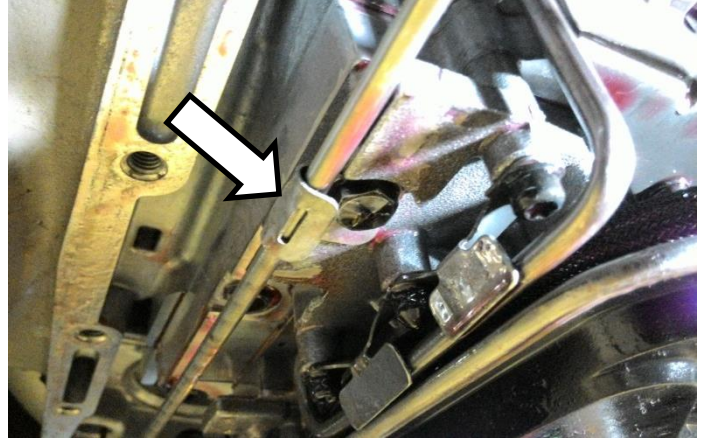

Install the manual lever on the outside of the transmission. Slide it fully down the shaft and tighten the pinch bolt.

Clip the shift cable back in place.

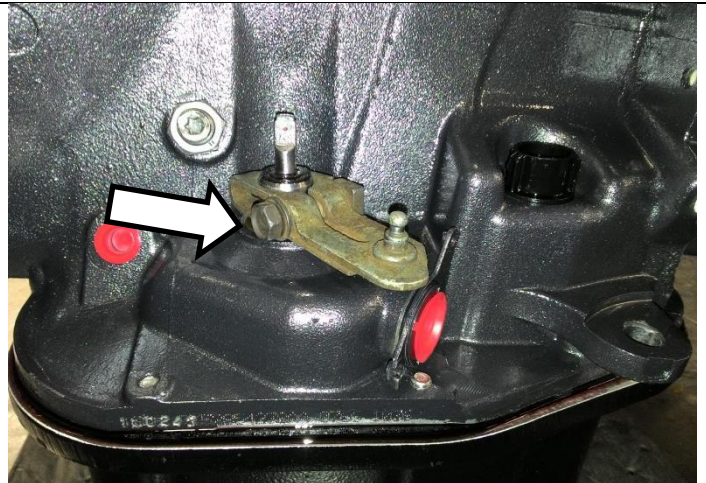

2005-2007 – Position the TTVA motor on the throttle valve shaft and swing it towards the transmission.

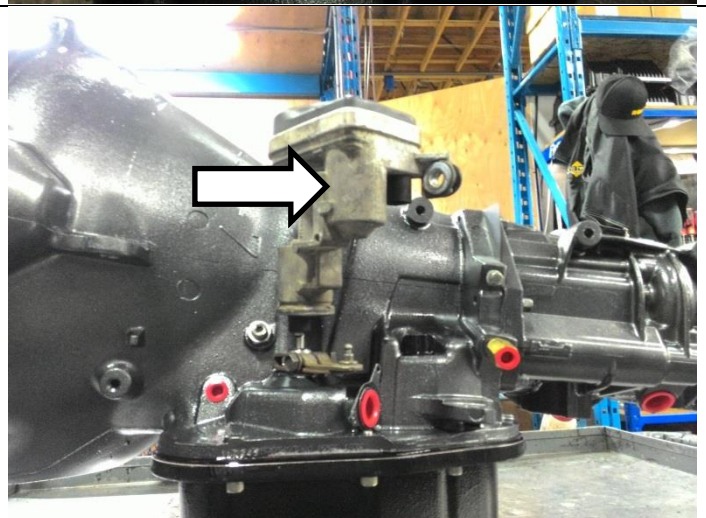

2005-2007 – Bolt the TTVA motor to the transmission case with the two bolts removed earlier. Plug in the TTVA motor electrical connector.

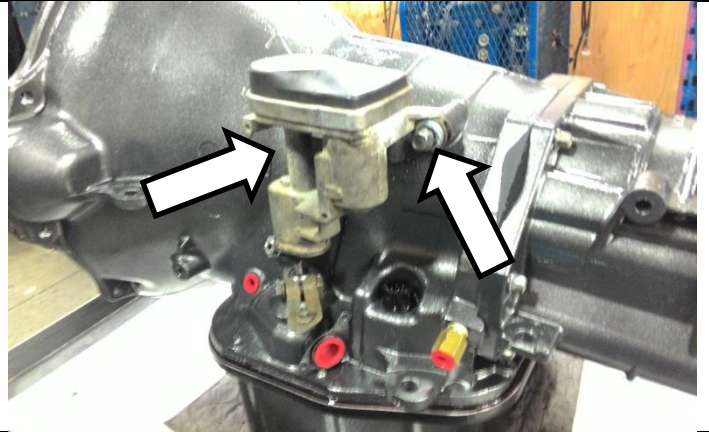

1996-2004 – Install the throttle valve lever above the shift lever. Tighten the pinch bolt to secure it in place.



1996-2003 – Reinstall the return spring on the throttle valve lever.

Clip the throttle valve cable back onto the lever.

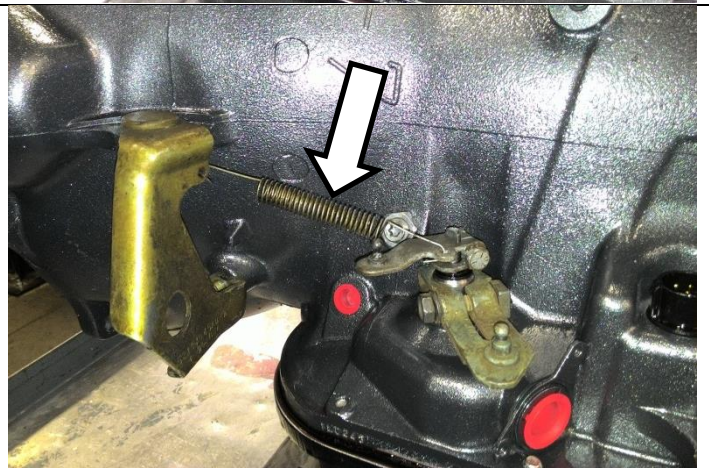

2003-2007 – Install the range sensor (PRNDL sensor) into the transmission. Attach with the two Torx fasteners. Torque to 45in-lb (3.7ft-lb).

Plug in the electrical connector.



1996-2002 – Install the neutral safety switch by screwing it back into the transmission. Torque to 25 ft-lb. Plug in the electrical connector.



Plug in the 8 pin round electrical connector to the transmission.

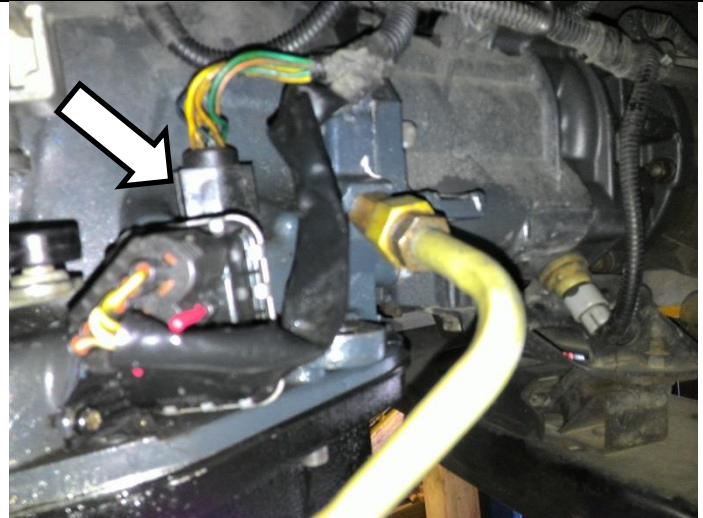

Install the transmission oil pan using the supplied pan gasket. Torque fasteners to 125in-lb (10ft-lb).

Suggestion A BD transmission pan adds extra capacity, cooling fins, a magnetic drain plug and adds stiffness – now is a good time to upgrade.



Refill the transmission with 8-9 quarts of ATF.

Important Do not overfill, top up as required.



Start engine and move the shift lever through the gears slowly, recheck fluid. The fluid level may drop slightly as the valve body is refilled with fluid.

Throttle Valve Adjustment/Initialization

Throttle Cable Adjustment (1996-2004)

Throttle cable (kick down cable) adjustment is critical for transmission operation. Adjustment of this cable changes shift points and transmission line pressure.

The kick down cable is located under the plastic cover shown. Remove the 2 Philips screws and unclip the cover.



Adjust the cable so the kick down lever is pulled all the way back (to its furthest travel) at wide open throttle. Check this with the engine off and pushing the throttle pedal to the floor.

Adjust the cable forward (towards radiator) to make the transmission shift earlier and to the rear (towards the firewall) to make it shift later.

Install plastic cover when complete.



TTVA Motor Re-Initialization (2005-2007)

Turn the key on for 30 seconds without starting the truck. This is the time required for the ECM to auto-zero the TTVA position.



Gear Shift Cable Adjustment (2003-2007)

The 2003-2007 trucks use a range sensor instead of a simple neutral safety switch. This is more sensitive and thus requires shifter cable adjustment be completed.



Shift transmission into PARK. Release cable adjuster tab (3) under steering column. Under the vehicle, ensure the transmission gearshift lever is centered in the park position (fully rearward). Back in the cab, ensure the shift lever is centered in the park detent and snap the adjuster tab (3) back in place.

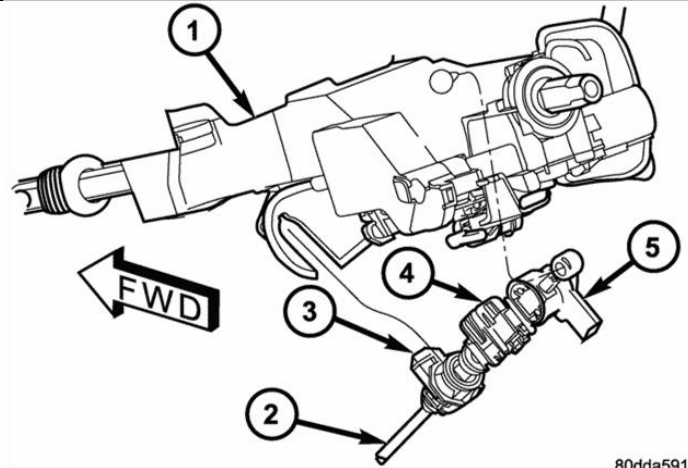

80dda591

Check the truck only starts in PARK or NEUTRAL to confirm adjustment.

Road Test and Verification

Recheck transmission pressures now that the valve body has been installed. Use the chart used at the beginning of the manual to confirm the increase in line pressure.



Test drive the vehicle. Confirm shift quality is acceptable and verify wide open throttle shifts are correct.

Before you call Tech Support

If you experience one of the symptoms below, please have these pressure tests completed before calling in as they will help with diagnosis.

2-3 STACK SHIFT / 2nd & 3rd GEAR STARTS

- TTVA relearn procedure completed?
- Governor Pressure @ 0 MPH = _____
- Governor PSI @ idle? _____
- Governor PSI @ 10 MPH? _____
- Transmission Governor pressure = Mainline pressure after 2-3 shift? _____
- Mainline Pressure = _____
- Checked to see if transmission has power? _____

LAZY SHIFT

- Line Pressure @ IDLE = _____
- Band adjustment checked? _____
- Band adjustment nut turns @ 72 in/lbs = _____ (# of turns)

Questions?

If you require assistance with this kit, please call our Transmission Technical Support Line at (800) 887-5030, Monday to Friday from 7:00-3:30pm Pacific Standard Time (PST).

Service Adjustments

Set the 2nd gear band adjustment. Torque the T40 band adjuster screw to 72in-lb, then back out 2-1/4 turns. Tighten lock nut while keeping adjuster screw from turning.

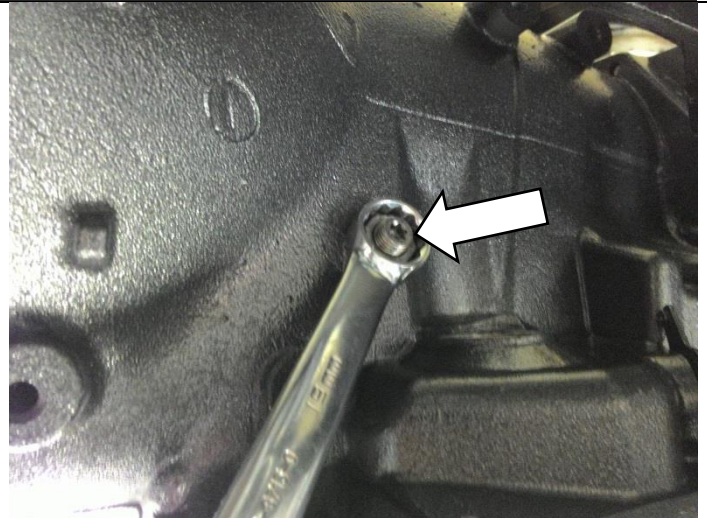

To confirm adjustment, pull the servo lever outwards. The airgap should measure 5/16". The flattened end of the supplied E-clip installer can be used as a feeler for this measurement.



Set the low reverse gear band adjustment. Loosen nut with 14mm wrench then back off the adjuster screw 5 turns. Next tighten the adjuster screw to 72in-lb, then back screw off 3 turns and tighten jam nut.

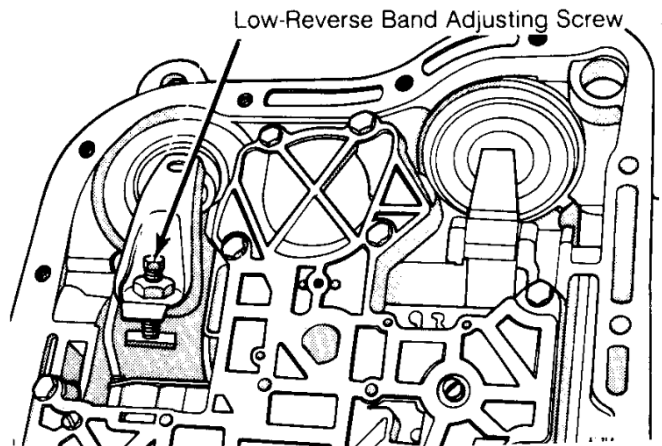



General Policy

All core returns must be,

- like for like, no mixed models
- drained of all fluids (\$50 Charge)
- be returned in the original packaging
- Part Disassembled
- No junkyard cores (core must have been removed from vehicle)
- No fire damage
- Free of excessive Rust or Water Damage

Returned cores that fail to follow the above conditions will be disallowed and scrapped or returned at the customer's expense. Freight and removal damage are not covered. BD Diesel reserves the right to adjudicate cores as it sees fit and may deviate from its policy.

BD FUEL INJECTION CORE ACCEPTANCE POLICY

Model	Deduction	No Credit
P7100 Injection Pump	<ul style="list-style-type: none"> • AFC Housing Damaged (25% Deduction) • Governor Housing Damaged Front or Back (25% Deduction) 	<ul style="list-style-type: none"> • Contaminated/Bio Diesel • Damaged Camshaft on 911/913 pumps. • Main Body Damaged
Bosch VE Pump	<ul style="list-style-type: none"> • AFC Housing Damaged (25% Deduction) • Cold Advanced Housing Damaged (50% Deduction) • Governor housing damaged front or back (25% deduction) • Main Body Damaged (50% Deduction) 	<ul style="list-style-type: none"> • Contaminated/Bio Diesel • Seized Head (Does not turn)
CP3		<ul style="list-style-type: none"> • Contaminated/Bio Diesel • Seized (Does not turn) • Catastrophic Shaft Failure (Frost Plugs Damaged or Missing) • Front Cover Damaged
VP44	<ul style="list-style-type: none"> • Damaged Electronics (50% Deduction) 	<ul style="list-style-type: none"> • Contaminated/Bio Diesel • Seized Head (Does not turn)
Common Rail Injectors	<ul style="list-style-type: none"> • Solenoid melted or destroyed, stretched terminals (25% Deduction) • 5.9/6.7 Broken Solenoid Terminal Divider (No Deduction) 	<ul style="list-style-type: none"> • Contaminated/Bio Diesel • Damaged Body
Mechanical Injectors		<ul style="list-style-type: none"> • Contaminated/Bio Diesel • Damaged Body

BD TURBOCHARGER CORE ACCEPTANCE POLICY

Turbo Model/ Application	Deduction	No Credit
Cummins ISX VGT Air or Electronic Actuated	<ul style="list-style-type: none"> • Damaged Electronics (50% Deduction) • Missing Clamps (25% Deduction) • Missing Parts or Actuators (50% Deduction) • Turbine Wheel Separation (50% Deduction) 	<ul style="list-style-type: none"> • Knock Off Models (Not Genuine) • Part Disassembled
Caterpillar (Ball Bearing) Models		<ul style="list-style-type: none"> • Knock Off Models (Not Genuine) • Wheel Separation
Caterpillar (Standard Turbocharger) 704604-9007, 704604-9011		<ul style="list-style-type: none"> • Knock Off Models (Not Genuine) • Turbo with 3 support Webs

Detroit Diesel VGT	<ul style="list-style-type: none"> • Damaged Electronics (50% Deduction) 	<ul style="list-style-type: none"> • Knock Off Models (Not Genuine) • Wheel Separation
Ford 6.4 Powerstroke	<ul style="list-style-type: none"> • Missing Parts or Actuators (50% Deduction) 	<ul style="list-style-type: none"> • Knock Off Models (Not Genuine) • Part disassembled • Wheel Separation
Ford 6.7 Powerstroke	<ul style="list-style-type: none"> • Missing Parts or Actuators (50% Deduction) 	<ul style="list-style-type: none"> • Wheel Separation
GM 6.6 L5P	<ul style="list-style-type: none"> • L5D Version (due to incorrect compressor cover) (25% Deduction) • Missing Parts or Actuators (50% Deduction) 	<ul style="list-style-type: none"> • Knock Off Models (Not Genuine) • Wheel Separation
Dodge Cummins 6.7 HE351VG/HE300VG	<ul style="list-style-type: none"> • Missing Parts or Actuators (50% Deduction) 	<ul style="list-style-type: none"> • Knock Off Models (Not Genuine)
Standard Turbochargers (All Models, Non VGT)	<ul style="list-style-type: none"> • Damaged Electronics (50% Deduction) • Missing Clamps (25% Deduction) • Missing Parts or Actuators (50% Deduction) 	<ul style="list-style-type: none"> • Knock Off Models (Not Genuine) • Wheel Separation

The above criteria apply to customer core returns. The following criteria will apply for core purchases.

Deduction	No Credit
<ul style="list-style-type: none"> • Cracked or Damaged due to freight • Damaged Electronics • Missing Parts or Actuators • Heavily Damaged Wheels and/or Shaft • Missing Clamps • Turbine Wheel Separation • Heavily Modified Turbochargers 	<ul style="list-style-type: none"> • Knock Off Models (Not Genuine)

BD TRANSMISSION/TORQUE CONVERTOR CORE ACCEPTANCE POLICY

Model	Deduction	No Credit
Transmissions	<ul style="list-style-type: none"> • Cracked Overdrive housings (\$100 Deduction) • 68rfe Cracked Case (25% Deduction) • Part disassembled (50% Deduction) • Missing Transmission Shipping Crate (\$200 Deduction) • Missing TC/Transmission bracket (\$50 Deduction) 	<ul style="list-style-type: none"> • Cracked Case (Except 68rfe)
Torque Convertors	<ul style="list-style-type: none"> • Hub and Impeller damaged. (50% Deduction) 	<ul style="list-style-type: none"> • Excessive corrosion • Part disassembled
Valve Bodies	<ul style="list-style-type: none"> • Missing electronics (25% Deduction) 	<ul style="list-style-type: none"> • Excessive corrosion • Part disassembled

GENERAL CORE ACCEPTANCE POLICY

Model	Deduction	No Credit
EGR Cooler		<ul style="list-style-type: none"> • Brackets broken

Please note that all cores have a time eligibility restriction. Please see BD Terms & Conditions for further details. https://cdn.bddiesel.com/downloads/bd_terms_general.pdf