

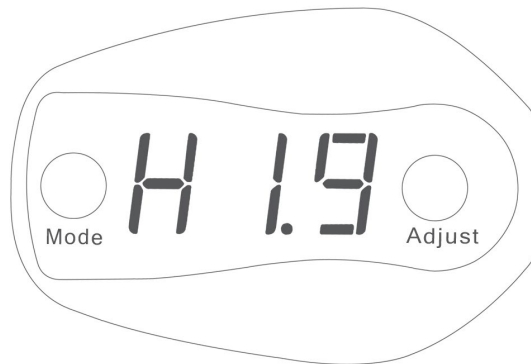

## Electronic Throttle Controller

### User Manual



Product picture

#### Part 1: Functions and Specifications

1. The electronic throttle controller will adjust the throttle sensitivity based off of the user defined modes. There are (8) modes and (9) levels of sensitivity for each mode.

2. There are 8 Modes the abbreviations are listed below:

H1 - Comfort mode

H2 - Sport mode

H3 - Race mode

EC - Fuel-Efficient mode

NOR - Normal model

SNO - Anti-Skid mode

OOO - Intelligent mode

LOC - Anti-Theft mode

3. There are 9 levels (1-9) for the sensitivity. Level 1 is a slow rate of acceleration and level 9 is a fast rate of acceleration.

## Part 2: Installation Instructions

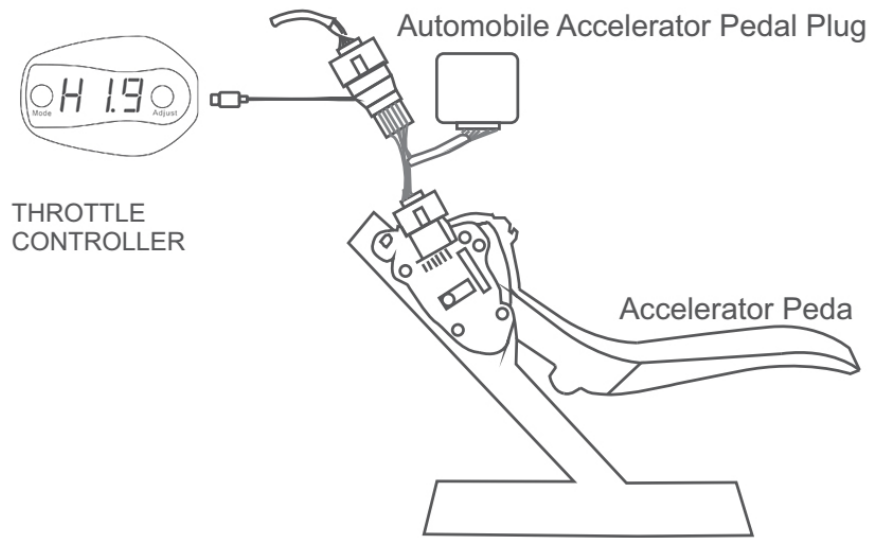

Installation Diagram

1. Connect the Throttle Controller with the accelerator pedal interface.
2. Stick the Throttle Controller on center console.
3. Connect the plug with the Throttle Controller, secure any loose wires.

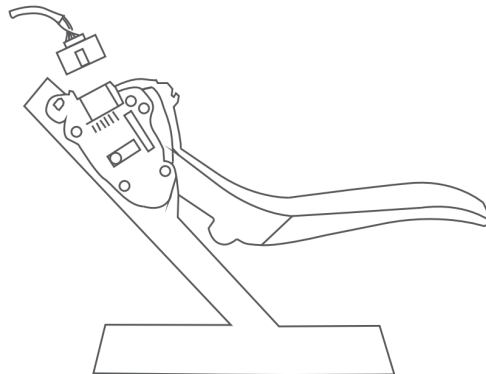

Picture 1

Step1:

Remove the plug from the factory throttle pedal. Please refer to picture 1.

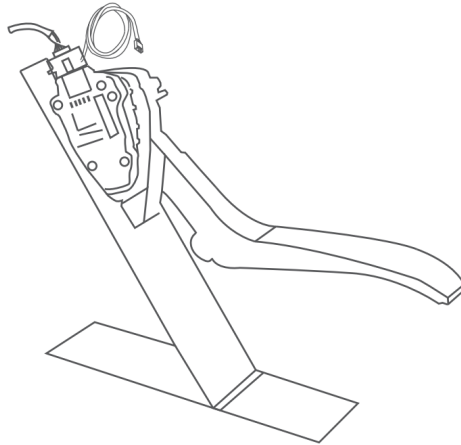

Picture 2

Step2:

Connect the throttle controller to the factory plug and the factory pedal.

Please refer to picture 2.

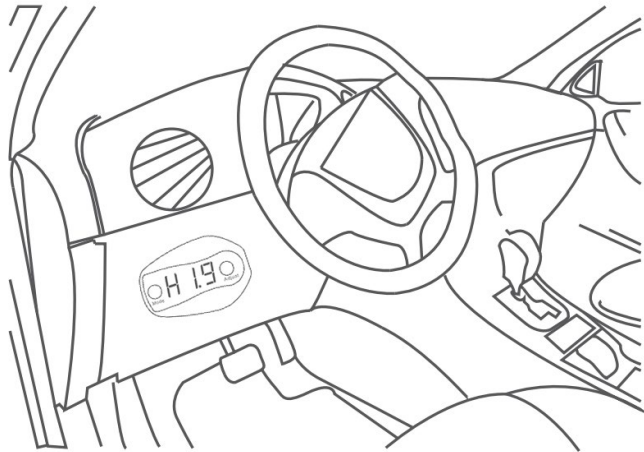

Picture 3

Step3:

Thoroughly clean the dash location where you plan to mount the throttle controller. It is recommended to use isopropyl alcohol to remove any silicone-based products from the dashboard. If the mounting surface is not thoroughly cleaned, it is possible the interface will not stick. Remove the tape backing from the user interface and firmly press it onto the dashboard.

### **Part 3: Safety Precautions**

- a. Before the installation, user needs to check the Electronic Throttle Controller plug and accelerator pedal interface, they are plug and play, and should not be forced.
- b. After finishing the installation, please start the engine in Neutral Gear or Park Gear, and check the accelerator pedal functionality.
- c. If installed incorrectly, the pedal will not function correctly, and a check engine light will appear in the gauge cluster. If in this situation, please don't worry, this product has a

internal protection circuit, which will prevent harm to the vehicle parts. Please turn off the engine and disassemble this product. After 2 minutes, install this product in the correctly.

#### Part 4: Operation

- a. This product will be operated using the “Mode” and “Adjust” buttons.
- b. This product can be adjusted any time, use caution when adjusting the product. Always be aware of your surroundings.



c. Press the Mode button Mode , it will show:

- H1 - Comfort mode
- H2 - Sport mode
- H3 - Race mode
- EC - Fuel-Efficient mode
- NOR - Normal model
- SNO - Anti-Skid mode
- OOO - Intelligent mode
- LOC - Anti-Theft mode



d. Adjust button Adjust can adjust the level of sensitivity from weak to strong, there are 9 levels (1-9), Please note: except the NOR-Normal Mode, all of above modes have 9 levels of adjustment.

#### Detail for 8 mode:

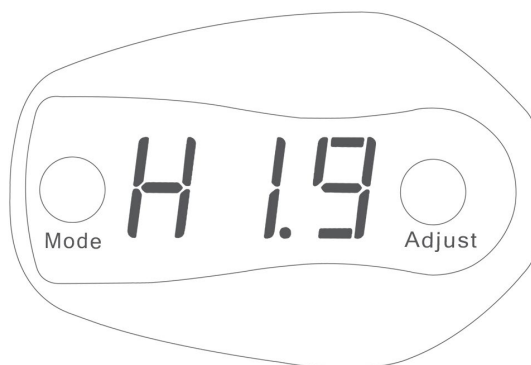

Picture 4

#### H1 Comfort Mode:

Increases throttle response with smooth, fast, acceleration. 1-9 levels to adjustment from weak to strong, picture 4 (H1.9) refer to comfort mode and level 9.



Picture 5

**H2 Sport Mode:**

Increases acceleration, to achieve the best acceleration rate, 1-9 levels to adjustment from weak to strong, picture 5 (H2.9) refer to Sport Mode and level 9.



Picture 6

**H3 Race Mode:**

Achieve superior acceleration and performance. 1-9 levels to adjustment from weak to strong, picture 6 (H3.9) refer to Sport Mode and level 9.



Picture 7

**NOR Normal Mode:**

Back to the Normal control mode. Throttle pedal will function the same as factory.

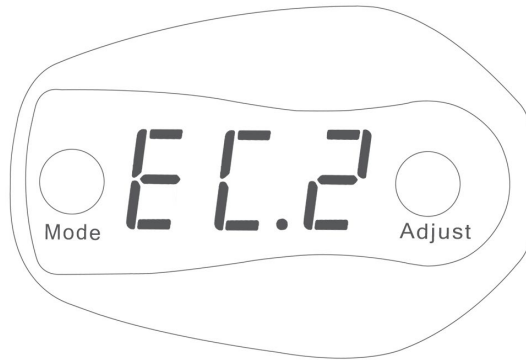

Picture 8

**EC Fuel-Efficient Mode:**

This will aim towards achieving better fuel economy. Result will depend on driving style and habits.

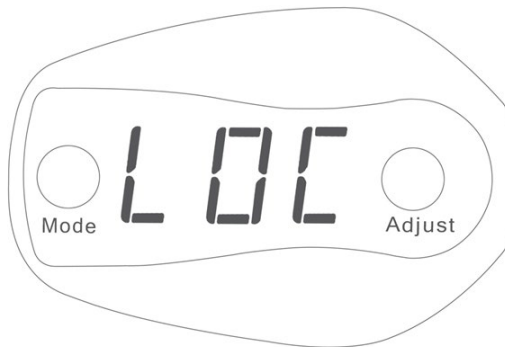

Picture 9

**LOC - Anti-Theft Mode:**

Throttle pedal will have no response. Only to be used when the vehicle is not moving. Do not change to this setting while driving.

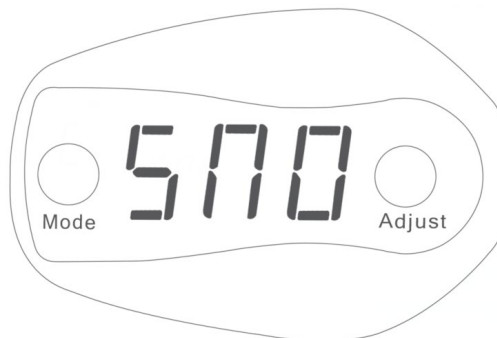

Picture 10

**SNO - Anti-Skid Mode**

Suitable for snow or slippery conditions. Help reduce tire spin by delaying the throttle response at initial acceleration.

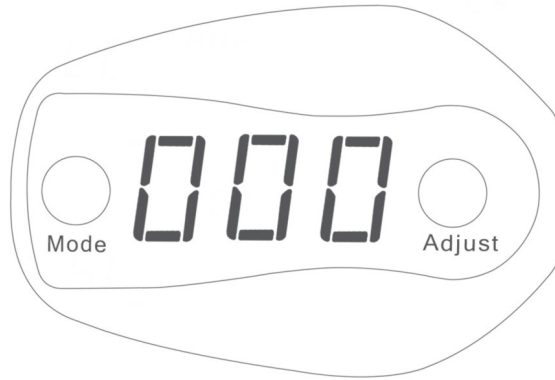

Picture 11

**000 - Intelligent mode**

Matches the acceleration automatically according to normal driving habits.

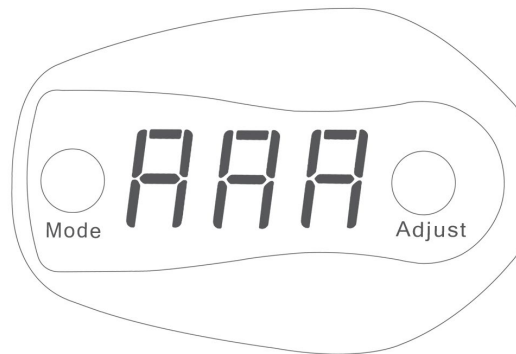

Picture 12

**Automatic Mode:**

Long press "Mode" button for 3 seconds, screen will show AAA, this will be used for vehicles with automatic transmissions.

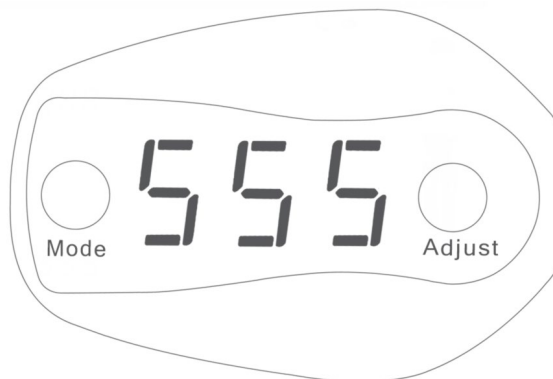

Picture 13

**Manual Mode:**

Long press "Adjust" button for 3 seconds, screen will show SSS, this will be used for vehicles with manual transmissions.

**Contents:**

Electronic Throttle Controller Screen-----1pc  
Accelerator Pedal Cable-----1pc  
User Manual-----1pc  
Host Cable-----1pc  
Cable Ties-----3pcs