

RETRAX

RETRACTABLE BED COVERS

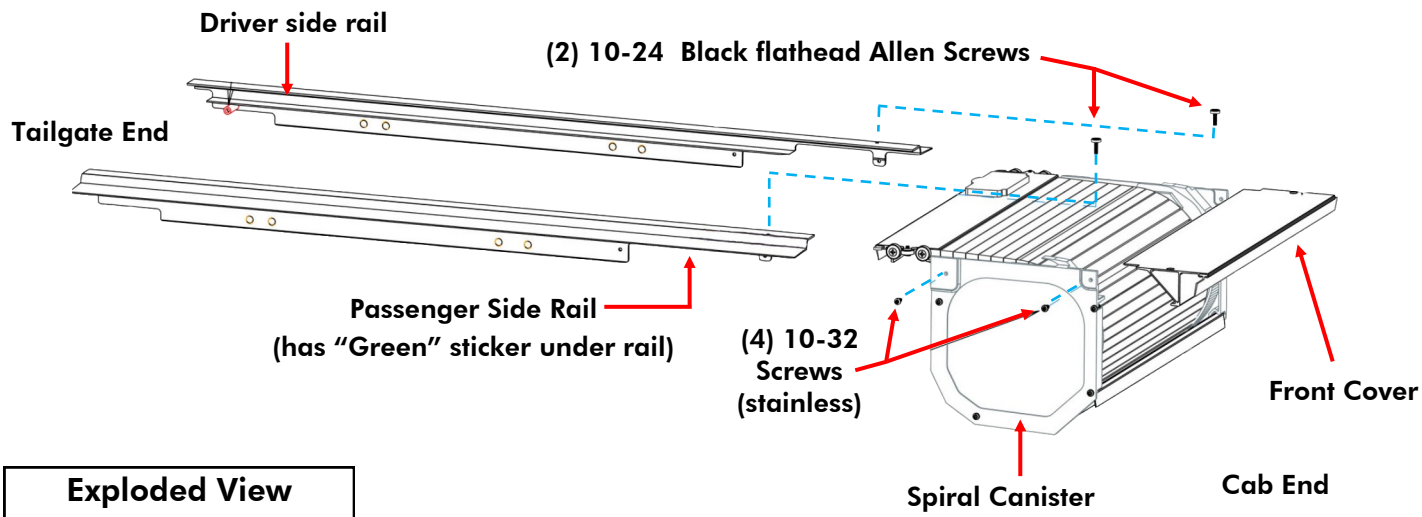

Manufactured in the USA

Retrax

917 South 46th Street
 Grand Forks, ND 58201
 P: (701) 746-5596 F: 746-5598
www.retrax.com
retrax@retrax.com
 1-800-206-4070

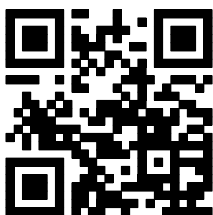

Scan here to view a brief video on how to install a **RETRAX** cover.

Make sure that you have a QR code reader application installed on your smartphone.

Table of Contents

NOTE: Some models require specific steps and parts. Please check below; if your model is listed, follow the instructions on that page!

Pre-assembly guidelines	Pg. 1
Steps 1-4 (cover assembly)	Pg. 2
Steps 5 & 6 (clamp install & measurements)	Pg. 3
Steps 7 & 8 (adjustments & final steps)	Pg. 4
Maintenance & Use	Pg. 5
Warranty Statement	Pg. 6
POWERTRAX	Pg. 7-8
Dodge Ram Box 2009-up	Pg. 9-10
Honda Ridgeline 2006-2015	Pg. 11-13
Honda Ridgeline 2017-up	Pg. 14
Nissan Frontier 2005-up	Pg. 15
Nissan Titan 2004-up	Pg. 16
Toyota Tacoma 2005– 2015	Pg. 17
Toyota Tacoma 2016-up	Pg. 18-20
Toyota Tundra 2007-up w/ Deck Rail System	Pg. 21

Please read and follow instructions before un-boxing and assembling the bed cover.

Keep boxes and packing until installation is complete. Unpack carefully to prevent scratching.

DO NOT remove protective films from cover and canister until after installation is complete.

DO NOT LUBRICATE OR USE LOCTITE ON *RETRAX*!! (VOIDS WARRANTY)

See Maintenance page for proper care.

If you have the *POWERTRAX* cover please see pages 7 & 8 for special installation!

Clamp Box and Drain Tube Kit

(2) rubber washers	A
(2) drain tubes	B
(4) clamps (6 clamps for 8' beds)	C
(2) 10-24 x 3/4" front cover mounting screws	D
(4) 10-32 x 7/16" rail to canister mounting screws	E
6mm Allen wrench	F
1/8" Allen wrench	G

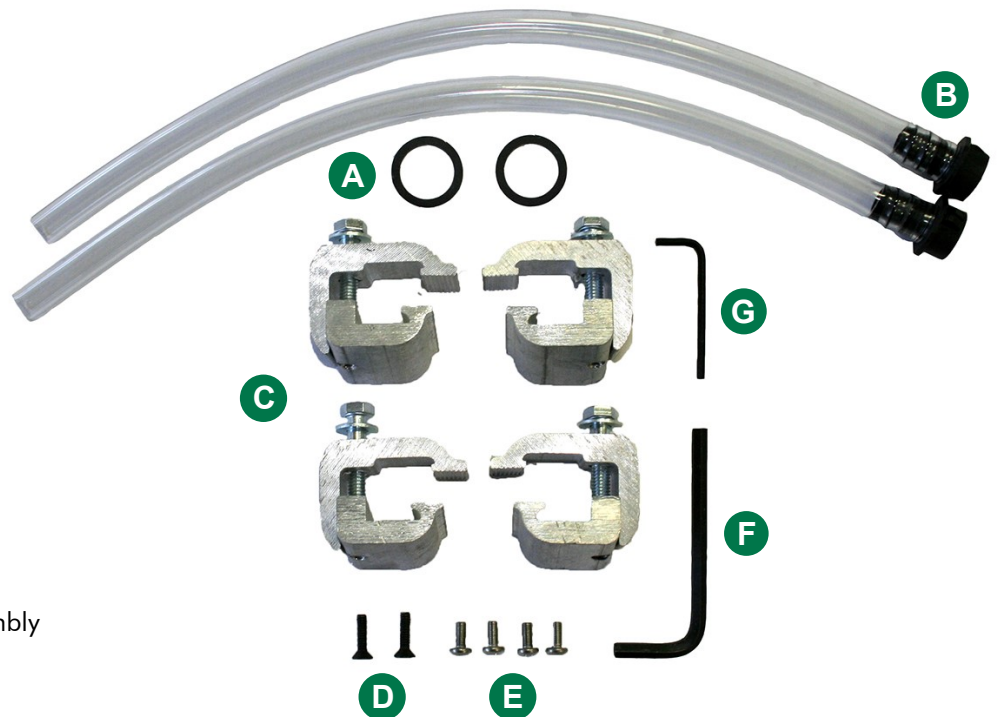

Parts in large box

- Instruction packet
- Cover rolled into canister-spiral assembly
- Front cover for canister
- Keys
- Drain tube kit

Parts in rail box

- Driver side rail
- Passenger side rail
- Clamp box (NOTE: Clamps in box may vary from photo)

Tools Required

- #2 Philips screwdriver
- 9/16" or 1/2" wrench (ratchet works best)
- Pliers or vice grips

STEP 1: Remove Shipping Materials

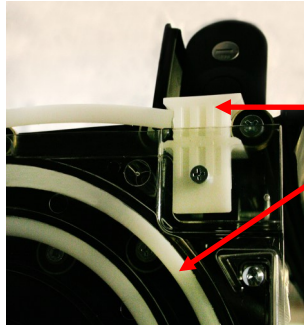

Remove shipping brackets and white shipping tubes from both sides of canister.

Keep shipping bracket for STEP 4

STEP 2: Install the rails to canister

Lift up lock cover and open lock by pressing release button. Pull cover out 6" - 8". DO NOT allow cover to roll back into canister until rail is installed.

POWERTRAX motor is not active yet, manually guide the cover into the rails.



Passenger rail has green sticker.

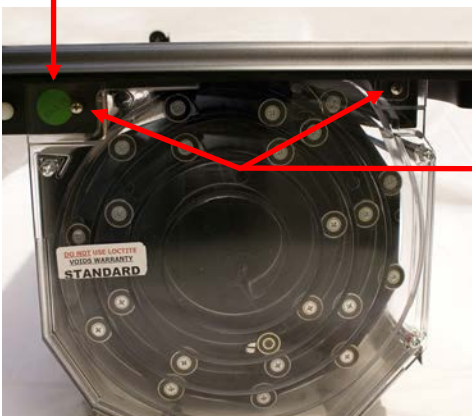

Attach both rails to canister using the 10-32 x 7/16" rail to canister mounting screws. Make certain the rail tabs are on the inside of the spiral.

STEP 3: Install the front cover

Slide on front cover and attach here on both sides with the (2) 10-24 x 3/4" screws. Use the 1/8" Allen wrench.

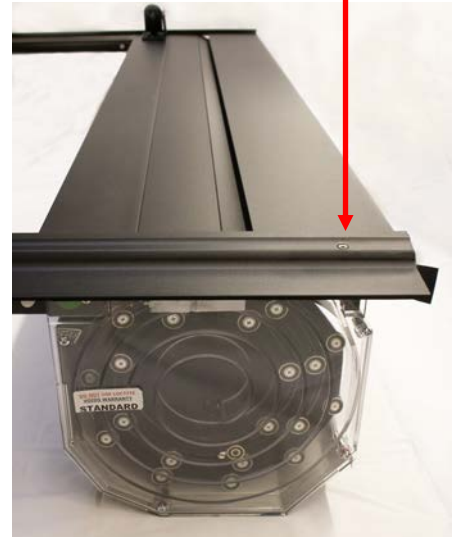

STEP 4: Lift the assembled cover into the bed and position the rails

Using two people, lift the cover and place it at the very front of the bed. Close the tailgate of the pickup.

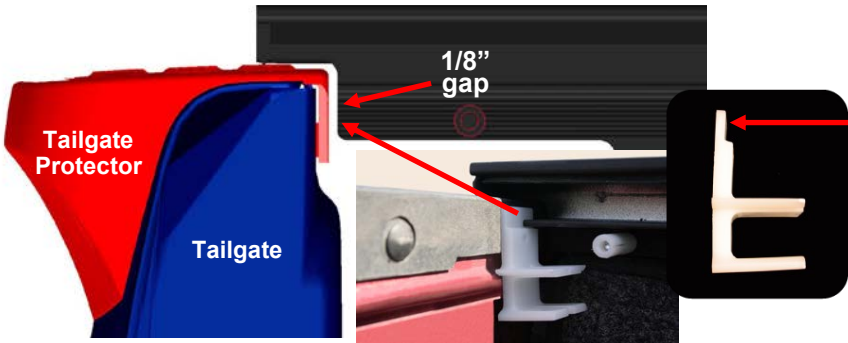

Move the rails to achieve the 1/8" gap using the 1/8" part at the top of the bracket. Make certain the rails do not move after measuring.

NOTE: Plastic bed liners may have to be cut or notched at the front of the bed if they touch the rolling canister. A jigsaw with medium tooth blade, Dremel™ or RotoZip® tool works well.

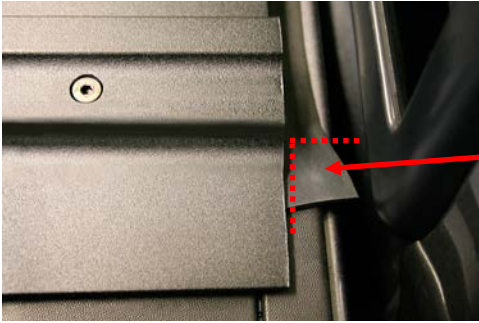

NOTE: The front cover weather-strip must lay flat across the truck bed. Make certain it is pointed towards the cab. If it extends past the bed rail cap, trim to fit right up to the cap on truck bed.

STEP 5: Install the front & rear set of clamps

Using a 9/16" or 1/2" wrench (depending on your clamps), tighten clamps.

When attaching rear clamps, push down on the rail as you tighten the clamps for a better seal on the pickup box rails.

The rear of the rail may need to be tilted up or down for best fit over the tailgate.

Some models do not use clamps. Refer to the appropriate manual section for proper mounting instructions.

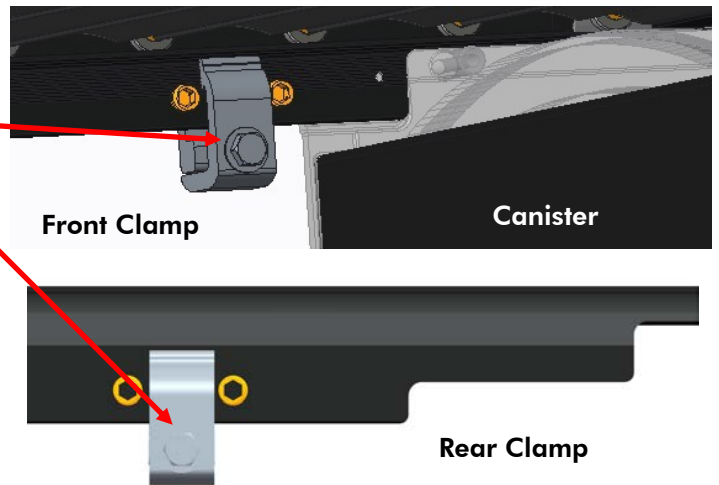

STEP 6: Measure and record the distance between the rails

Measure the distance at point **A** (above front cover). Then measure at points **B** and **C** (above the clamps), they must be the same as point **A**.

The rails must be parallel, if not then adjustments are needed, proceed to step 7.

If parallel, proceed to step 8.

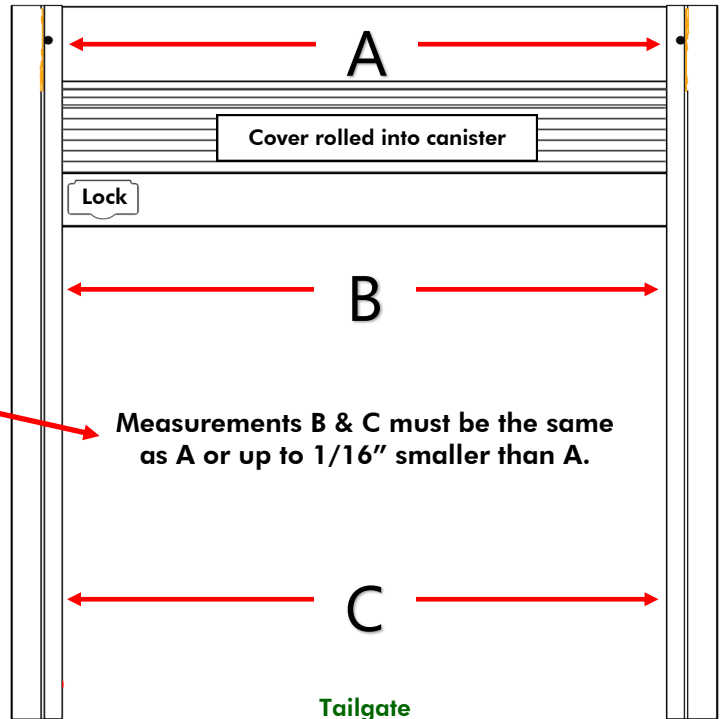

STEP 7: Adjust the distance between the rails



Tailgate end of passenger rail

Remove clamp and turn both of the white nylon adjustment screws, using a 6 mm Allen wrench. One complete turn of adjustment screws = 1/16" of adjustment.

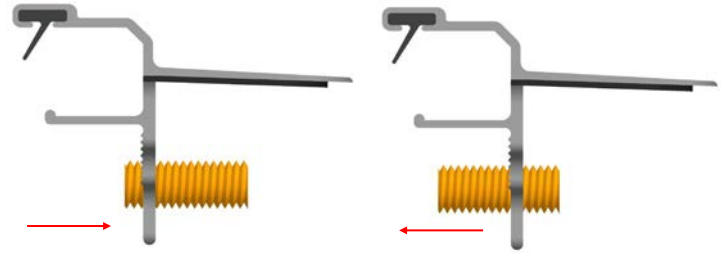

*Rails too far apart = clockwise

*Rails too close = counter clockwise

Some models do not use adjustment screws. Refer to the appropriate manual section for proper adjustment instructions.

You can check for proper fit between front cover and rolling cover

Pull the cover closed and latch.

If there is less weather-strip exposed on one side, adjust that rail towards the cab. Replace and tighten the clamps and close the cover. Check again for equal spacing at the front and readjust if needed.

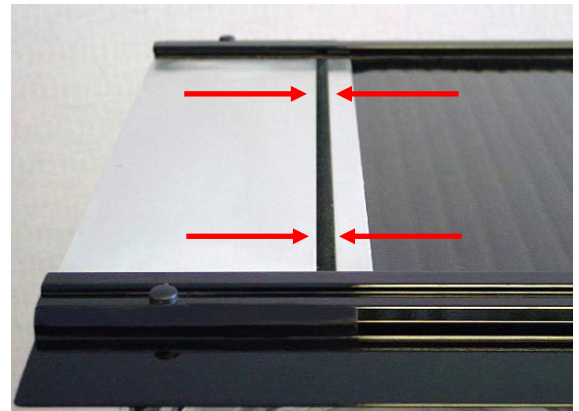

STEP 8: Assemble and install drain tube

Remove plastic film from the canister.

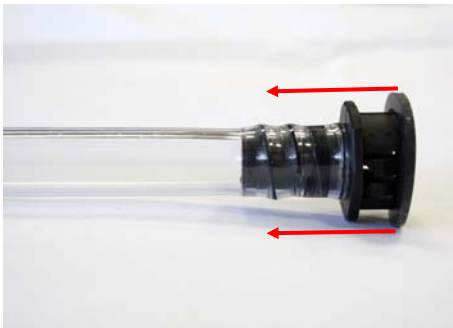

Insert tubes into the holes in the bottom of the canister and turn to the right. **2 clicks means they are secured.**

On some trucks there are factory drain holes in both front corners, on others there are plastic plugs that can be drilled out for the tubes. You can enlarge existing holes or drill new holes in the front wall or floor if needed. Be careful of what is behind when you drill. If using a plastic bed liner, then holes can be drilled through the liner only. Cut the tubes to length to fit in desired locations.

POWERTRAX model refer to pg. 8

Final notes: Open and close the cover to ensure it is rolling without rubbing or binding. Remove any remaining plastic film. Be sure that all clamps and/or bolts are tight. Clamps must be periodically checked for tightness. The top surface of the rails should be level. Loosen clamps or bolts, adjust the rail, and tighten if needed. On some models, a better fit over the tailgate may be obtained if the rear of the rails are slightly tilted up or down.

The **RETRAX** cover has superior quality rail weather-strip seals. These seals help minimize water intrusion into the pickup bed. The initial break-in period for the rail weather-strip is about 48 hours in the fully closed position. Your cover may be slightly harder to open and close during the break-in period.

Use

Opening and Using the Cover

To use your **RETRAX** cover, open the lock cover and press the button at the center of the latch to pop open the handle.



Closing and Locking the Cover

To latch your **RETRAX** cover anywhere along the rail, push down firmly on the end of the lock handle. Insert key and make sure it locks and unlocks.



Securing Loose Cargo

RETRAX covers help transporting loose and large pieces of cargo safe and secure; a unique feature that most tonneau covers cannot claim. To help secure any item too big to fit under the cover, latch the lock handle shut against the item to help keep it in place.



CAUTION! All large and heavy cargo must be secured by straps etc.

Retrax Holdings, LLC is not responsible for shifting cargo.

Maintenance & Care

Cleaning and Caring for your Cover

You can wash and wax your **RETRAX** cover, but do not use any plastic cleaners, protectants, or strong chemicals. With proper care, the polycarbonate cover will last many years. It should be cleaned with mild soap and water. Do not allow gasoline to come in contact with the cover.

Carnauba wax is fine on your **RETRAX** cover, however, **DO NOT wax the ONE MX or PRO MX (matte) cover!!** To restore the luster to aluminum parts, periodically use a polishing compound followed by a non-abrasive Carnauba wax. The weather-stripping on your cover may absorb soapy residue from a car wash, so we recommend wiping down the inside of your rails from time to time.



IMPORTANT: NEVER spray any lubricant or cleaner in the rails. THIS WILL VOID YOUR WARRANTY. The ball bearings are sealed and will not need any sort of lubricant or spray. If the rails do feel a little 'sticky', you may rub some Paraffin (candle) wax along them until they wear in.

Retrax (referred to as the manufacturer) warrants each new Retrax retractable pickup bed cover to the original owner (non-transferable) as follows:

The RetraxONE and RetraxONE MX have a limited lifetime warranty for the failure of materials and workmanship. Warranty replacement costs will be prorated after one (1) year.

The RetraxPRO, RetraxPRO MX, PowertraxONE, PowertraxONE MX, PowertraxPRO and PowertraxPRO MX have a limited lifetime warranty for the failure of materials and workmanship. Warranty replacement costs will be prorated after three (3) years.

Items not covered under warranty:

- Normal wear over the life of the Retrax cover, to include fading or discoloration
- Water intrusion at any location or any damage caused as a result
- Other dealer and/or purchaser installed parts & accessories

Conditions which will void all warranty:

- Lubrication of the rails or sealed ball bearings
- Altering the Retrax covers in any manner without written approval by the manufacturer
- Use for any purpose other than the normal intended use
- Misuse, negligence, or accident
- Installation of any other part or accessory which comes in contact with or may interfere with the Retrax cover without written approval of the manufacturer
- Failure to adequately secure cargo to prevent damage to the Retrax cover
- Acts of God or other external causes

Conditions and Limitations:

This warranty is subject to certain conditions and limitations including, but not limited to, the following:

- Any part of a Retrax retractable pickup bed cover that is found to be defective under the terms of this warranty will be repaired or replaced using either new or reconditioned parts at the discretion of the manufacturer.
- In determining what constitutes a failure under the terms of this warranty the decision of the manufacturer will be final
- The warranty is applicable to the original purchaser only and is not transferable to subsequent purchasers.
- The manufacturer does not accept any responsibility in connection with the installation of any of its products by its dealers or agents
- Without regard to an alleged defect of its products the manufacturer under any circumstances does not assume responsibility for loss of time, inconvenience revenue, or other consequential damage including, but not limited to expenses for telephone, food, lodging, travel, loss or damage to the vehicle the products are installed on or loss or damage to personal property of the purchaser or user of the products.
- The manufacturer does not undertake responsibility to any purchaser for warranty expressed or implied by any of its dealers, distributors or agents beyond which is contained herein.
- The manufacturer reserves the right to make changes in the design of, improvements to, or warranty of its products without imposing any obligation upon itself to provide the same for any products manufactured previously.
- Under no circumstances shall Retrax be liable for special, indirect, incidental, or consequential damages sustained in connection with the Retrax model covers.

Some states do not allow limitations on how long the implied warranty lasts, so the aforementioned limitations may not apply to you.

Claim Procedure:

If a part fails, the purchaser should return to the selling dealer to determine if the failed part is covered under the terms of this warranty. If a claim is necessary, the dealer will contact Retrax. If it is impractical for the purchaser to return to the selling dealer, then the purchaser may contact Retrax directly at **1-800-206-4070**. The defective part, along with a copy of the original bill of sale, must be returned prepaid to Retrax at **917 S. 46th St. Grand Forks, ND 58201**. At the manufacturer's discretion, photos, a copy of the original bill of sale and the serial number may be submitted in lieu of the returned damaged product to Retrax. After determining the validity of the warranty claim, Retrax will ship a replacement part prepaid to the customer. Labor costs to replace defective parts are the responsibility of the purchaser. If at any time you need warranty assistance please call **1-800-206-4070** or email us at **retrax@retrax.com** and one of our technical reps will be happy to help you. When calling or emailing, please be prepared to reference your part number and serial number.

IMPORTANT: Follow these instructions **BEFORE** installing the **RETRAX** cover.

Use caution when cutting the wire ties holding the wire harness together so you do not cut wires. Inspect wiring. Do not install damaged wires as they could become a hazard.

Split wire loom	A
Fuse holder	B
(2) - 10 Amp fuses	C
Wire harness	D
(10) wire ties	E
Electronics	F
LED lamp	G
Electric cover accessory packet	H

Electric Cover Accessory Packet

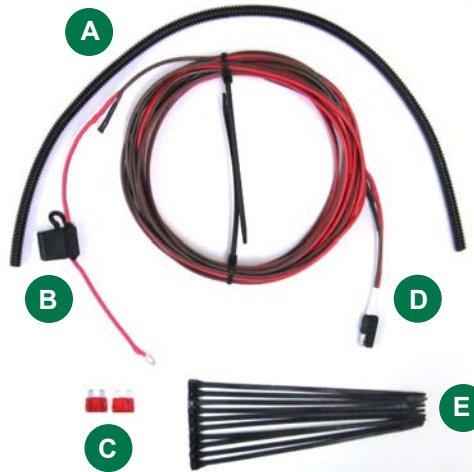

Driver Side Spiral Canister



STEP 1-3: Routing wiring harness from battery to truck bed

1. Using a Wire tie, secure the fuse holder end of the wire harness near the battery (red wire and brown wire)
Note: Do not connect the wiring harness to your battery yet.
2. Route the wire harness to the driver side of the truck if it is not already. (Using wire ties, secure the wiring harness so it does not come into contact with moving parts or exhaust pipes.)
3. Route the wiring harness down along the frame rails to the truck box as shown on the right. Keep the wires as high as possible to prevent damage while driving. Secure the wiring harness with wire ties every 2-3 feet.

Wiring Harness Routing Along Frame Rail

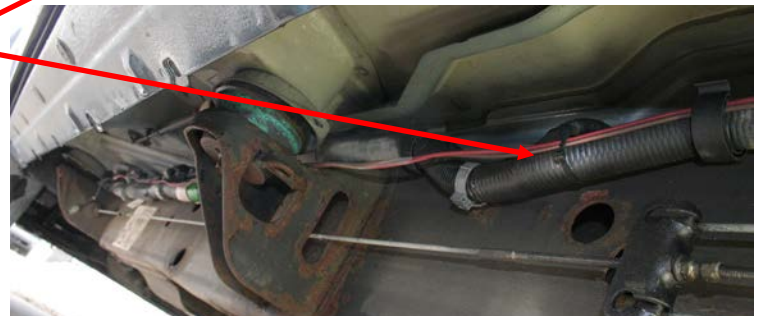

STEP 4: Wiring Options

OPTION 1: Route 24" of wire to driver side cab end of drain holes in the bed. Use split wire loom to wrap around the wires as a barrier between the wires and the drain tube hole. (NOTE: this may require a larger hole than normal.)

OPTION 2: Route the wiring in the gap between the cab and truck bed (leave about 24" in truck bed). The wires will be hidden under the front weather-stripping of the **RETRAX** cover.

← Proceed with the **RETRAX** standard instructions on steps 1-8 Then → refer back to this page for connection of wiring. **Disregard all references to 'lock' - Not applicable for POWERTRAX.**

NOTE: The electric cover has no lock assembly. Cover will not move out of the canister at this point of installation.

STEP 5: Connect the wiring harness to electronics box and battery

A. There is a white label wrapped with the letter "P" on it to ensure proper connections are made. (Ensure the connectors labeled P are securely connected. (Connectors labeled "M" will come attached.)

B. Connect the wires to the battery and install a fuse in the fuse holder. The **RED** wire (with the fuse holder) to the **POSITIVE** post, and the **BROWN** wire will connect to the **NEGATIVE** post.

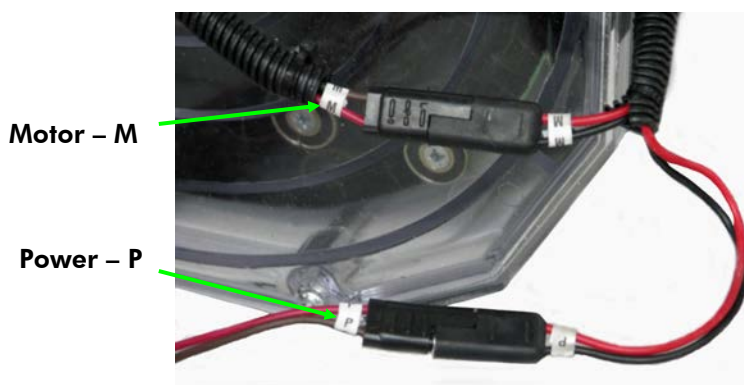

For proper cover operation, ensure rails are positioned correctly (must be parallel). See step 6 & 7 in standard instructions).

These surfaces must be level

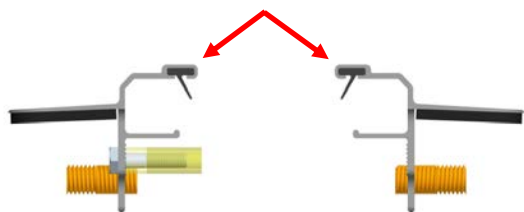

Operation of the **POWERTRAX**

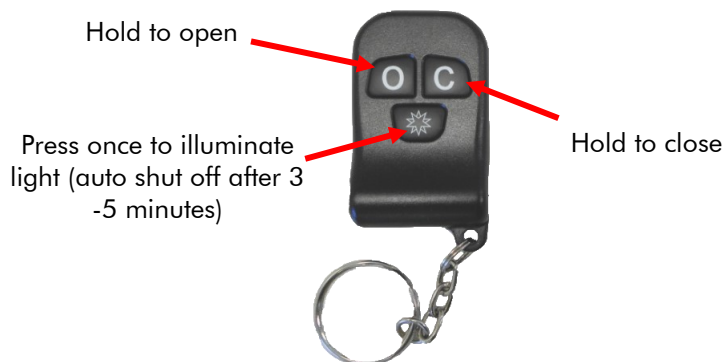

NOTE: The **RETRAX** cover has superior quality rail weather-strip seals. The weather-strip seals will have an initial 48 hour break in period. Please inform the end user to help the cover to the tailgate each time the cover is opened for the first 48 hours or until it is able to close completely on its own.

Dodge Ram Box 2009-up

Check the parts shown here, this model has different requirements than the standard parts.

Continue with standard instructions through step 3 (pg. 2), then return back to this guide on how to install the mounting hardware.

(6) 5/16-8 x 1" bolts	A
(6) 5/16" lock washers	B
(6) mounting blocks	C
(6) 1/4" flat washers	D
(6) 1/4-28 x 1" bolts	E
(6) t-slot nuts	F
0.050" spacers (optional for step 7)	G

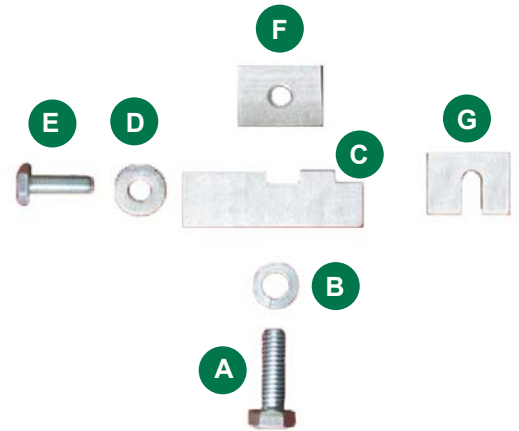

STEP 1: Measure and mark the top of the factory track for mounting block locations

Make a mark at the 3 spots shown below.

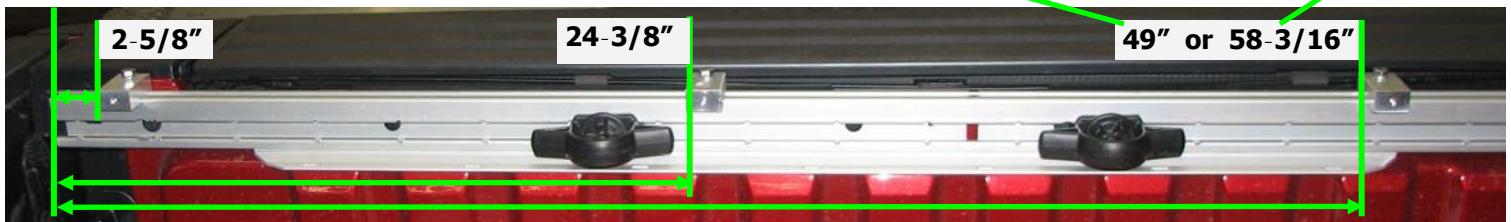

Tailgate end

STEP 2: Assemble and position 6 mounting blocks

Tighten t-slot nut, lock washer, and bolt securely with 1/2" wrench. Repeat with middle and back mounting blocks.

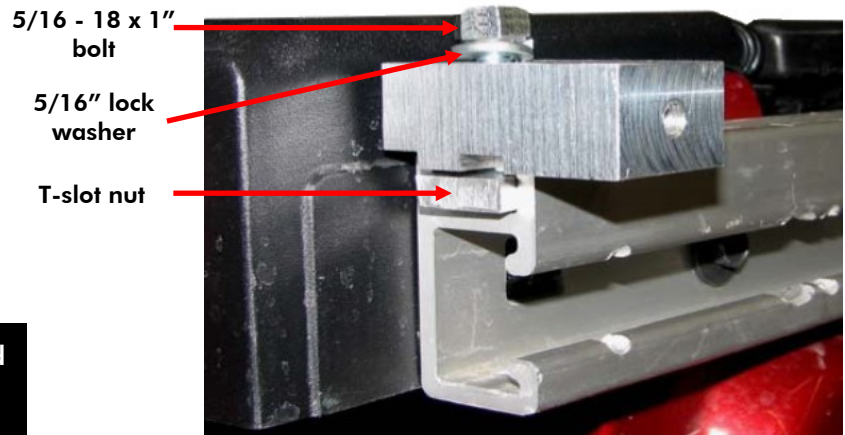

STEP 3: Lift the assembled cover into the bed and position the rails

Using two people lift the cover and place it at the very front of the bed. Close the tailgate of the pickup.

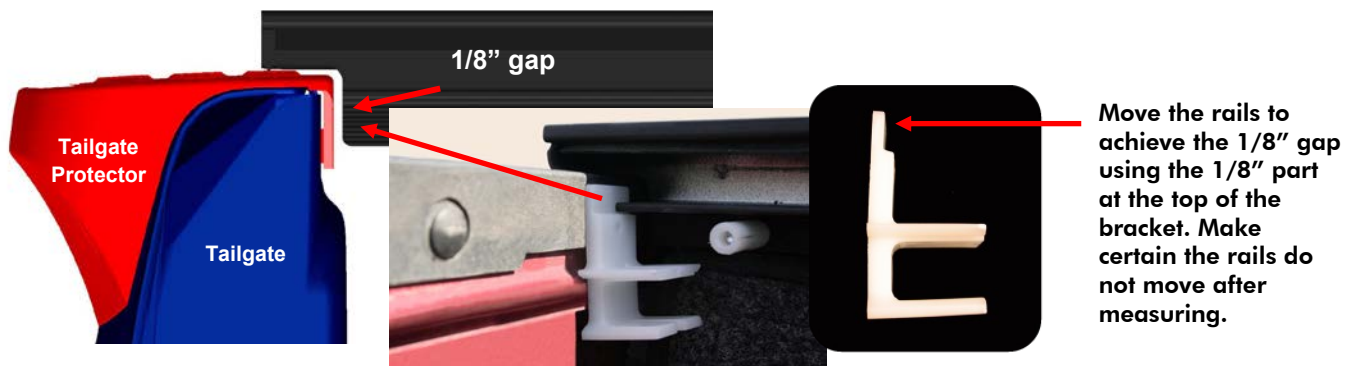

NOTE: The front cover weather-strip must lay flat across the truck bed. Make certain it is pointed towards the cab. If it extends past the bed rail cap, cut to fit right up to the cap on the truck bed.

STEP 4: Position and bolt *RETRAX* rails to mounting blocks

Center the threaded holes in the mounting blocks behind the openings of the *RETRAX* rail. Install 1/4" - 28 x 1" bolt and flat washer in all 6 holes. Use a 7/16" wrench to fasten.

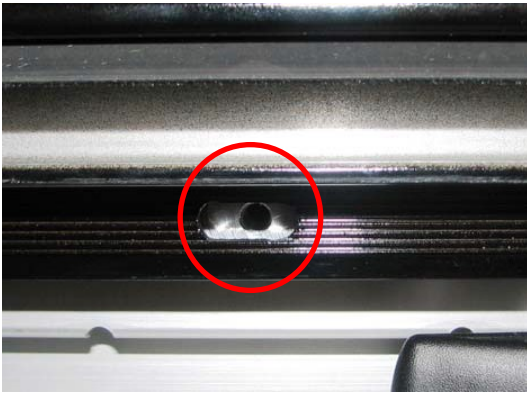

Continue with standard instructions on step 6 (pg. 3)

FOR STEP 7 IN STANDARD INSTRUCTIONS:

The .050" spacers can be used to narrow the distance between the rails if needed to get the rails parallel to each other. Position the spacers between the back of the *RETRAX* and mounting block.

NOTE: Due to the unique configuration of the Dodge Ram Box rails and toolboxes, it is not possible to completely seal the bed with a bed cover. 18" of 1/2" thick self-adhesive weather-strip has been provided that can be applied where desired at the owner's/installer's discretion.

Check the parts shown here, this model has different requirements than the standard parts.

(4) M6 x 40mm (metric) Allen head mounting bolts	A
(2) 1/4" lock washers	B
(2) 1/4" flat washers	C
(2) nylon spacers	D
(4) 10-24 x 1" stainless screws with black caps	E

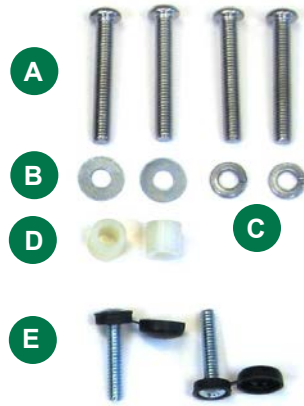

4mm Allen wrench	F
#40 Torx insert bit	G
(2) foam fillers for front tie-downs	H
(2) plugs for middle holds (step 8)	I
(2) front mounting brackets	J
Newer models may need rubber spacer at passenger rear mount	K

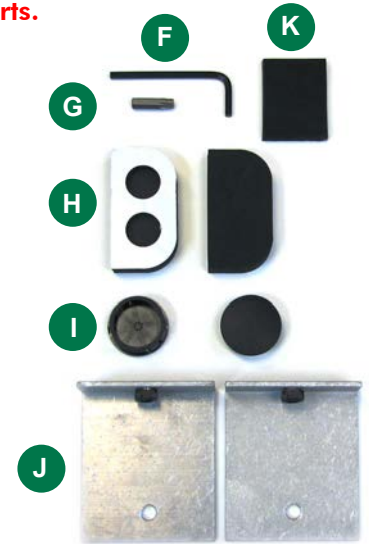

Continue with standard instructions through step 3 (pg. 2), then return back to this guide on how to install the mounting hardware.

STEP 1: Attach adhesive to rails

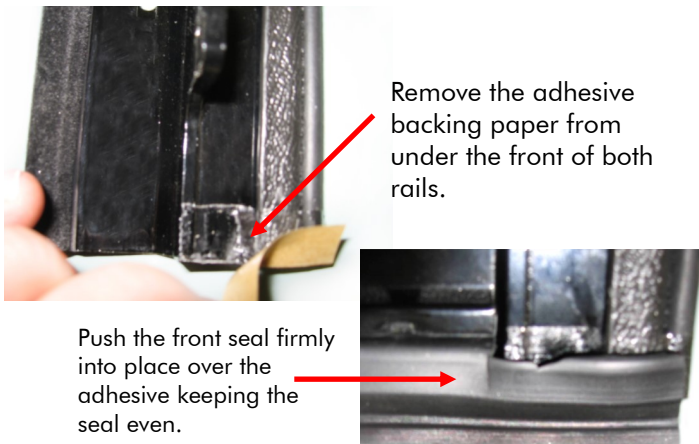

STEP 2: Remove factory bolts

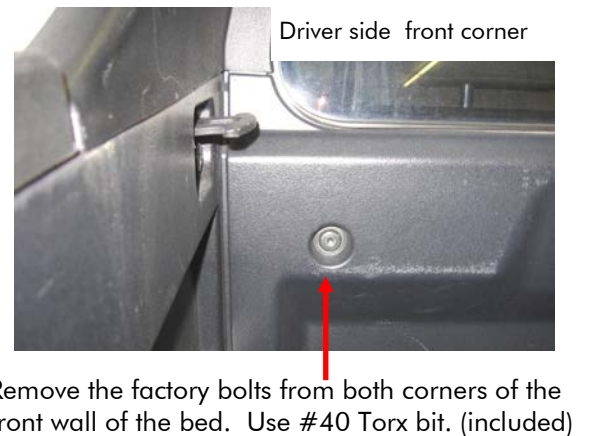

STEP 3: Remove factory screws

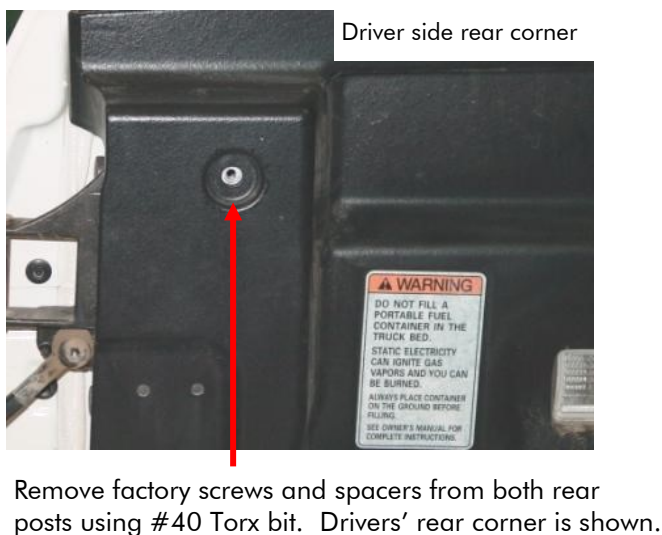

STEP 4: Attach foam to tie downs

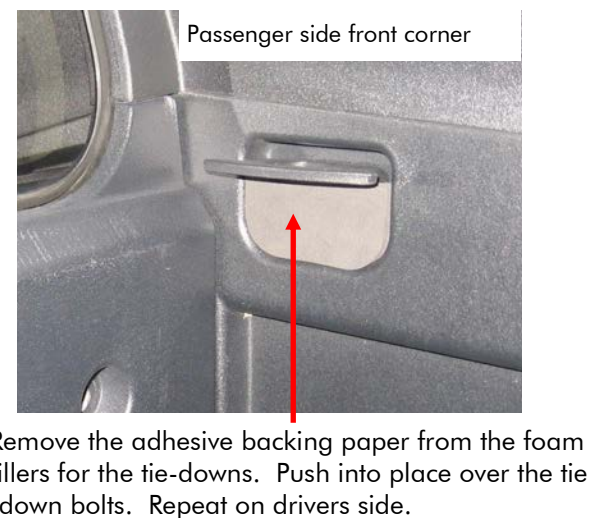

STEP 5: Install front mount brackets

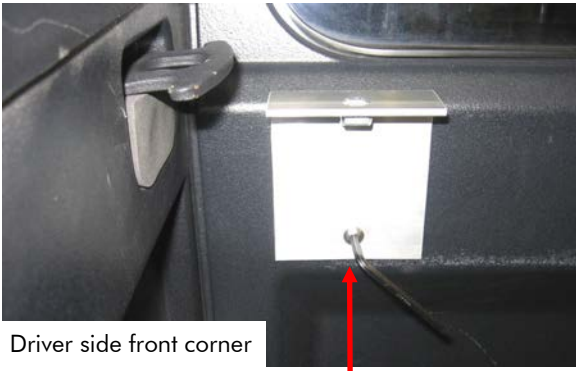

Driver side front corner

Install front mount brackets as shown. Slide lock washer onto M6 x 40mm bolt, push bolt through hole in mount bracket and start threading into front holes in the bed. **Hold mount bracket level** and tighten using the 4 mm Allen wrench. (included) Repeat on passenger side.

STEP 6: Insert plastic plugs

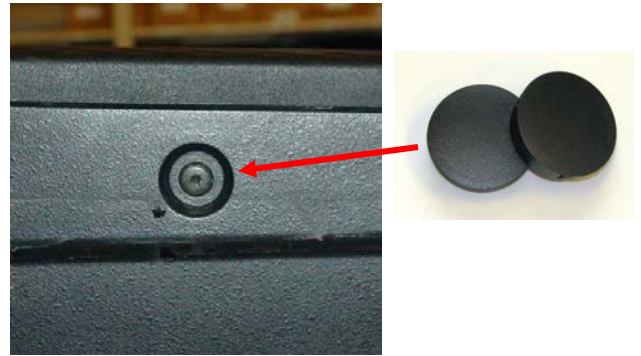

Insert black plastic plugs into middle holes. Push the 2 supplied plugs into the 2 middle factory holes on both sides of the bed.

STEP 7: Lift the assembled cover into the bed

Using two people, lift the cover and place it at the very front of the bed. Close the tailgate of the pickup.



STEP 8: Attach front cover to brackets

Start threading the (2) 10-24 x 1 mounting screws w/ black caps through the front cover into the front mount brackets. Do not tighten yet. Once rear brackets are tight, then fully tighten front screws using a #2 Phillips screwdriver. Fasten screw cover when finished.



Passenger side front corner

STEP 9: Attach rear end to brackets

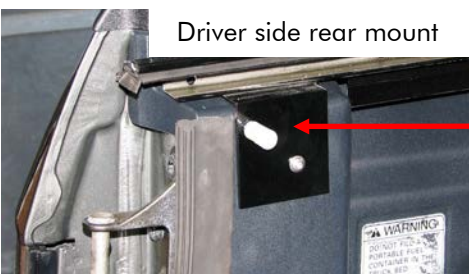

Driver side rear mount

Start rear mounting screws. Slide a flat washer onto the (2) M6 x 40mm (metric) rear mount bolts, insert bolts through holes in rear rail brackets, then insert nylon spacer and start threading into factory holes at rear. Use 4mm Allen wrench.

STEP 10: Select proper mounting hole location

Passenger rear mount holes

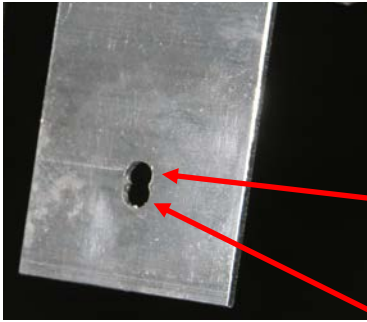

On the passenger rear mount plate, the hole used depends on if the rubber spacer is needed (see step 11). Most 2008 and older beds use the upper holes without the spacer. During the 2008 model year the passenger side of the Honda tailgate was raised slightly. The late

2008 and newer models use the lower hole and the rubber spacer. This is needed for clearance over the tailgate.

STEP 12: Assemble and install drain tube

Remove plastic film from the canister.

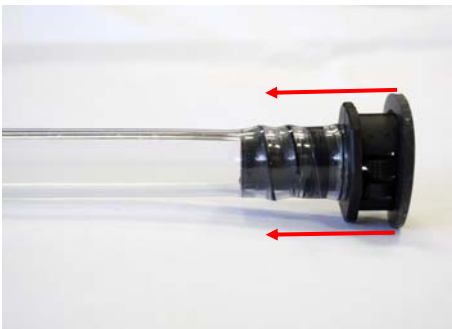

Insert tubes into the holes in the bottom of the canister. **Make certain they are clicked in all the way for proper drainage. 2 clicks means they are secured.**

Optional Rail Weather Adjustment: The inside walls of the Ridgeline bed have a slight bow outward from front to back. This can cause a slight gap between the rail weather strip and the side wall of the bed. The rail weather strip can be moved towards the bed wall if needed. Slide the weather strip firmly against the wall to close the gap.

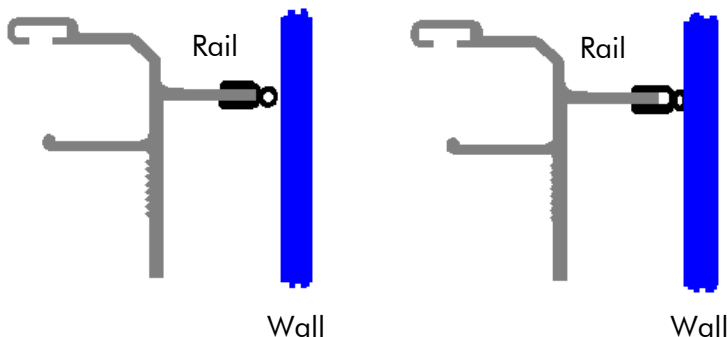

Rearview passenger side rail

Rearview passenger side rail

STEP 11: Add rubber spacer

Passenger rear mount

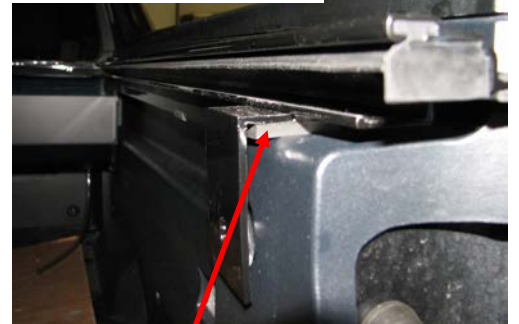

The rubber spacer provided can be added under the passenger rear mount bracket for proper clearance over factory tailgate protector.

Peel off adhesive strip from rubber spacer and attach spacer underneath mount bracket.

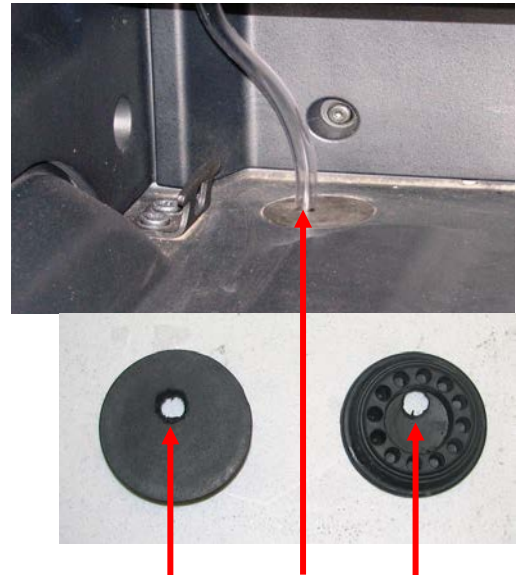

You can pass the tubes through the 2 factory plastic bed bolt covers. Remove the covers and drill a loose 1/2" hole or a 9/16" hole for the tubes. Offset the holes as shown.

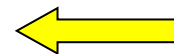

Refer back to the standard instructions for final notes, maintenance, use, and the warranty statement.

The 2017 Ridgeline requires a rail mount to be installed before the installation of the *RETRAX* cover.

Check the parts included in the rail box (shown below).

(4) Small rail bracket	A
(4) Large rail brackets	B
(8) Rail mount screws	C
(2) Rails	D

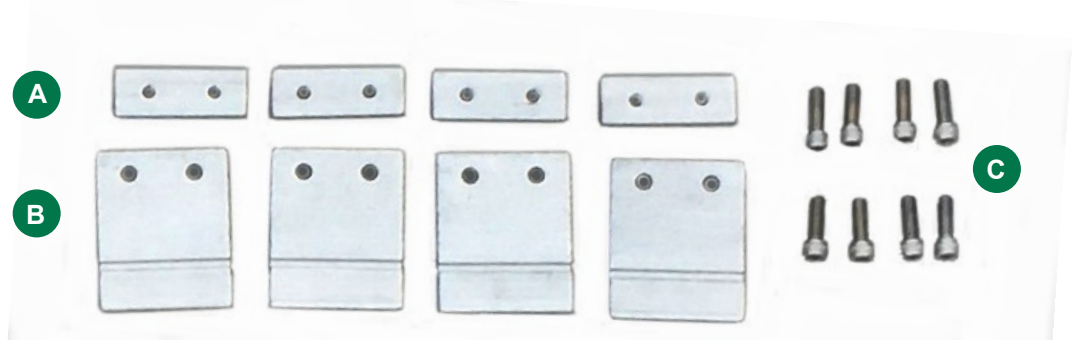

Follow the mounting instructions on the insert for the kit (included in rail box).

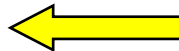
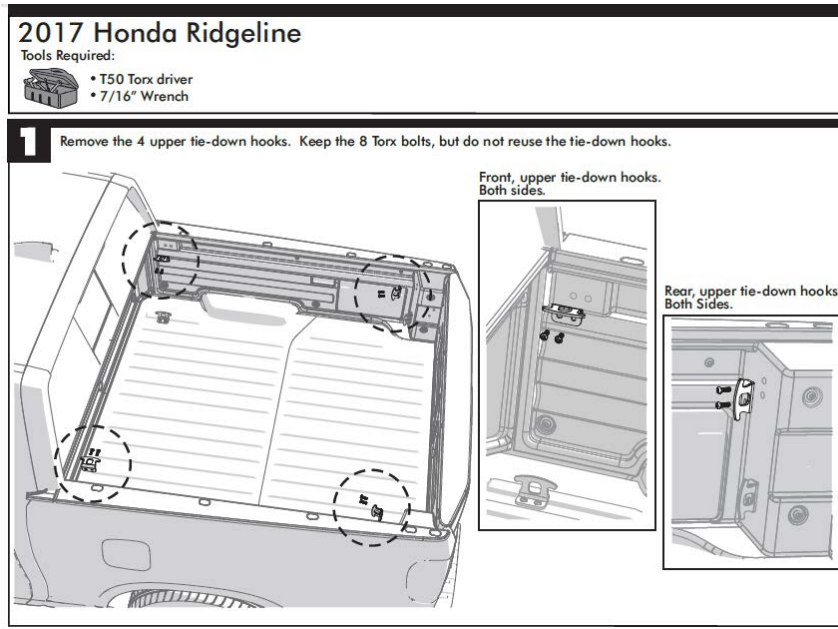

Once the rail kit is installed, continue with the standard instructions for the *RETRAX* cover on page 1.

Check the parts shown here, this model has different requirements than the standard parts.

WITH Utili-track:

(4) bracket bolts	A
(4) rail bolts	B
(4) 1/4" lock washers	C
(4) nylon washers	D
(8) 1/4" flat washers	E
(4) rail brackets	F

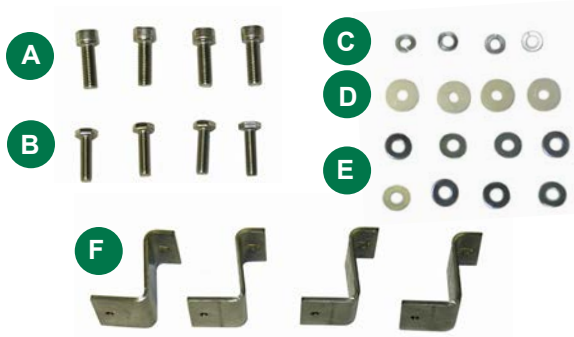

Follow standard instructions through step 3, (pg. 2) then refer back to this guide on how to install mounting hardware.

WITHOUT Utili-track:

The Frontier with no Utili-track uses the clamps below.



Continue with the standard instructions on Page 1.

STEP 1: Remove the bolts from existing Utili-track rails and attach brackets

Remove all 8 white nylon rail adjustment spacers from the rails then proceed below.

Frontier Crew Cab

Remove these bolts from both sides

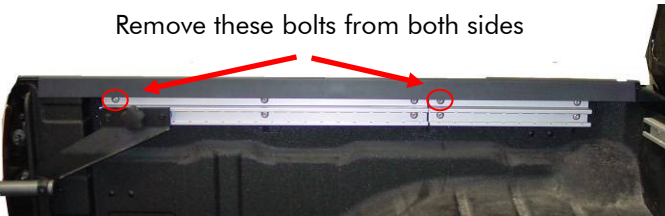

Frontier King Cab

Remove these bolts from both sides

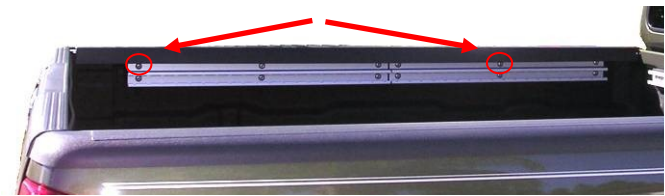

Attach all 4 rail brackets to these holes using the 4 bracket bolts (long leg points up).



FOR STEP 7 IN STANDARD INSTRUCTIONS:
To decrease the distance between the rails you add spacers next to the nylon washers between the **RETRAX** rail and the rail bracket. To increase the distance between the rails you remove washers or use thinner washers in place of the nylon spacers.

STEP 2: Lift the assembled cover into the bed and position rails

Using two people, lift the cover and place it at the very front of the bed. Close the tailgate of the pickup. Using the 1/8" part at the top of the supplied shipping bracket, move the rails to achieve the 1/8" gap between the tailgate.

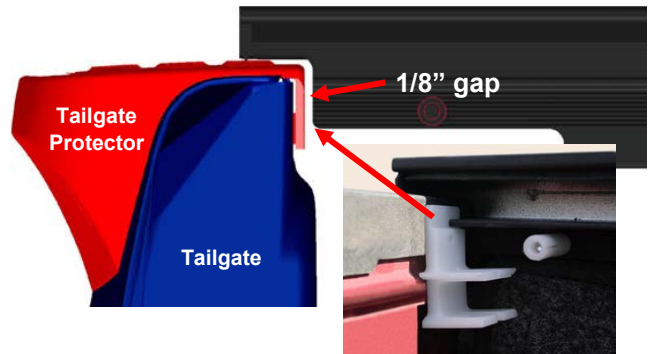

STEP 3: Attach RETRAX rails to rail brackets

Use a rail bolt with lock washer and flat washer and insert through hole in **RETRAX** rail then use 1 white nylon washer between the rail and rail bracket. Start threading the rail bolt into the rail bracket.



Continue with standard instructions on step 6 (pg. 3)

Check the parts shown here, this model has different requirements than the standard parts.

WITH Utili-track:

The Titan that has the Utili-track uses the clamps below.



Follow standard instructions through step 3, (pg. 2) then refer back to this guide on how to install mounting hardware.

STEP 1: Remove plastic caps

Remove and save the black plastic cap at the rear of the Utili-track on both sides of the truck.

NOTE: The factory tie-downs may cause interference with the lock when rolling.

Option 1: Use as is and push lock handle down slightly to bypass the factory tie-downs.

Option 2: Remove the tie-downs before installation. (disregard further reference to tie downs.)

Option 3: Smaller aftermarket tie-downs may be utilized in place of the larger original tie-downs.

STEP 3: Re-insert tie downs and 2nd cleat

Re-insert tie downs into the track. Insert 2nd mounting cleat into track system on each side and position it underneath the white nylons spacers closest to the tailgate. Finish by re-inserting the black plastic cap into the rear of the track system.



Continue with the standard instructions at step 4 (pg. 2)

WITHOUT Utili-track:



The Titan with no Utili-track uses the clamps above. Continue with the standard instructions on Page 1.

STEP 2: Insert mounting cleats

Loosen and slide out the movable truck tie downs on each side of the bed. Insert (1) mounting cleat into the track system on each side, position it underneath the white nylon spacers **closest to the front of the bed**. **Important: Hole should be toward bottom of channel.**

FOR STEP 5 ON STANDARD INSTRUCTIONS:

This photo shows how the clamp will mount to the rail. It is **important** to be sure that the threaded hole on the cleat is closest to the bottom of the C-Channel.

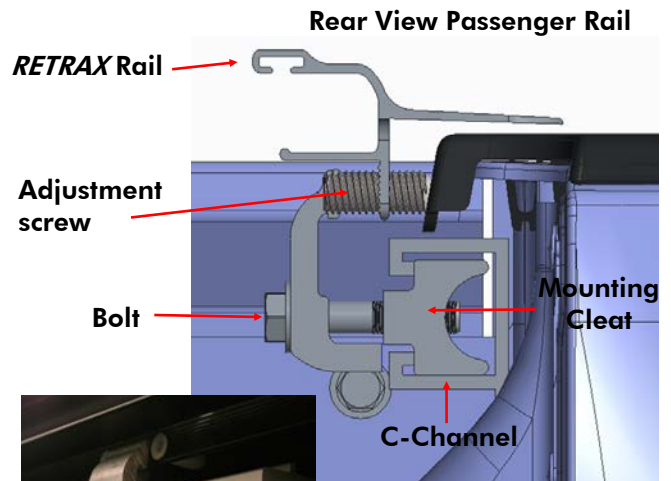

Check the part shown here, this model has different requirements than the standard parts.

(8) rubber rail adjustment spacers	A
(4) cleats	B
(4) rail spacer blocks	C



Follow standard instructions through step 3, (pg. 2) then refer back to this guide on how to install mounting hardware.

STEP 1: Install front rail gasket

Be sure foam is added to front bed rail, not the C-Channel rail. Trim to fit.

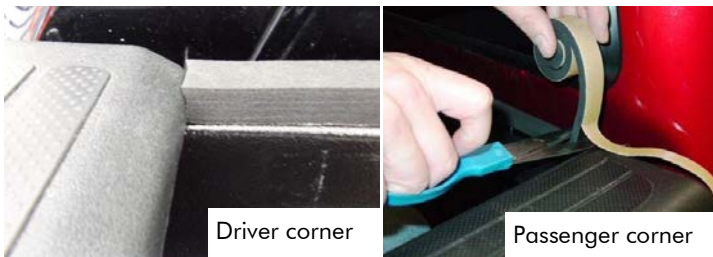

STEP 2: Insert mounting cleats

Remove and save the black plastic cap at the rear of the Deck Rail track system on both sides of the truck. Loosen and remove tie-downs or other accessories from each side. Insert (2) mounting cleats into the track system on each side.



STEP 3: Lift assembled cover into bed and position the rails

Using two people, lift the cover and place it at the very front of the bed. Close the tailgate of the pickup.

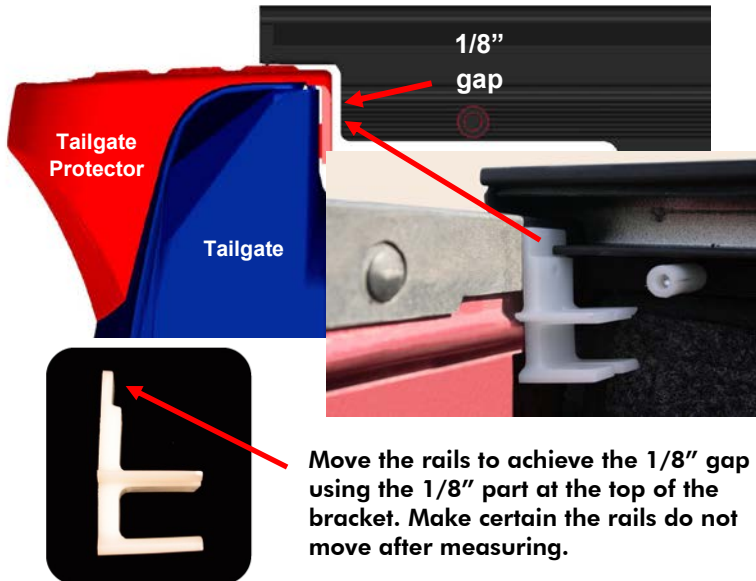

STEP 4: Bolt rails to pickup bed rails

Position rail spacer block and cleat in line with the hole in the rail. Start threading bolt with washer into cleat. Attach using a 9/16" wrench. Repeat at other 3 mount locations. Keep rail level when tightening bolts.



Rail spacer block

FOR STEP 7 IN STANDARD INSTRUCTIONS:

If the rails are too far apart add rubber rail adjustment spacers. Loosen the rail mount bolt and slide spacer between bed cover rail and rubber side of spacer block.



Continue with the standard instructions at step 6 (pg. 3)

Check the parts shown here, this model has different requirements than the standard parts.

Tools Required: T-30 torx driver

5' MODEL PARTS

(4) 1/4" flat washers	A
(4) 1/4-28 x .75 fastener	B
(4) 3/8-16 x 1.5 fastener	C
(4) 3/8" split washer	D
(4) cleats	E
(4) 0.050 adjustment shim	F

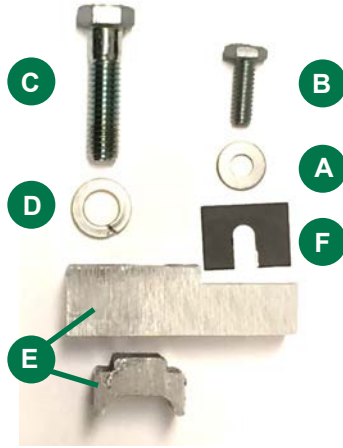

6' MODEL PARTS

(4) 1/4" flat washers	A
(4) 1/4-28 x 1.5 fastener	B
(4) 3/8-16 x 1.5 fastener	C
(4) 3/8" split washer	D
(4) cleats	E
(4) 0.050 adjustment shim	F
(4) plastic spacer blocks	G

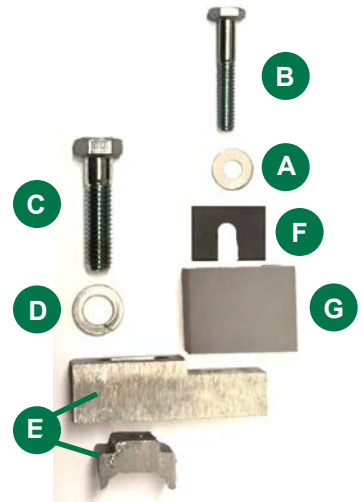

[6' model proceed to pg. 19](#)

RECOMMENDED FOAM (5' model only)

Remove film from the canister on the 5' model only, before installation.

On the 5' model, there is an aluminum lip that sticks out on the bottom of the canister. The supplied foam pieces are recommended to prevent scratches on your truck. With the edge of the cover facing you, roll the canister **90° away** from you. The foam will line up with the rear-bottom fold. Remove adhesive backing and apply the foam to both sides.



Rear-bottom fold



5' MODEL ONLY:

Remove the front tie downs in the bed. Use a T-30 torx.



STEP 1: Install seal

FOR BOTH MODELS:

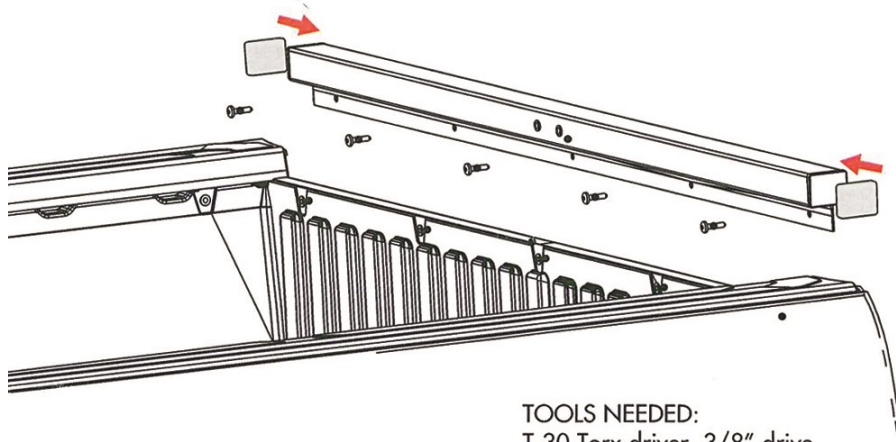

TOOLS NEEDED:
T-30 Torx driver, 3/8" drive short extension, ratchet

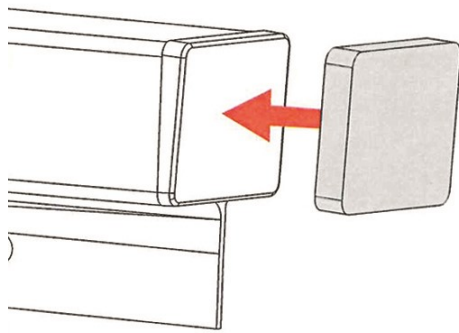

- 1 Remove factory cab header rail
- 2 Use T-30 Torx driver to remove 5 fasteners securing header rail to front bulkhead below cab rear window
- 3 Peel backing paper off of foam seal and adhere to header rail endcaps
- 4 Reposition factory cab header rail on truck bed
- 5 Install and torque all mounting bolts to 7.5Nm (66.5 lbs-in)

STEP 2: Insert mounting cleats

Remove and save the black plastic cap at the rear of the Deck Rail track system on both sides of the truck. Loosen and remove tie-downs or other accessories from each side. Insert (2) mounting cleats into the track system on each side.



STEP 3: Bolt spacers to RETRAX rails

1. Mount spacer block prior to cover installation to pickup bed.
2. Use the 1/4-28 fastener and 1/4" flat washer on the inside of the rail. Attach with 7/16" wrench.

Passenger side rail

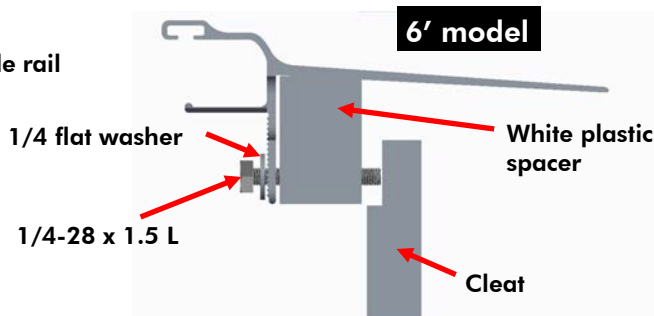

Passenger side rail

5' model

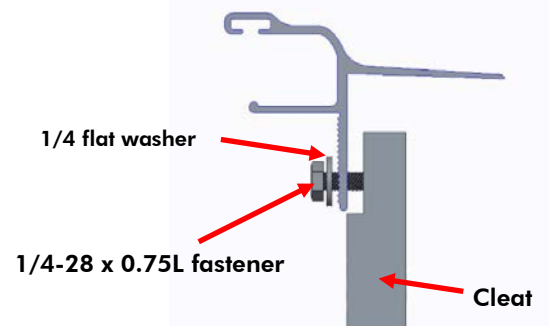

← Continue with standard instructions through step 6 (pg. 2) **DISREGARD STEP 5**, then refer back to this guide on how to install and adjust the mounting hardware. →

STEP 4: Bolt rails to pickup bed rails

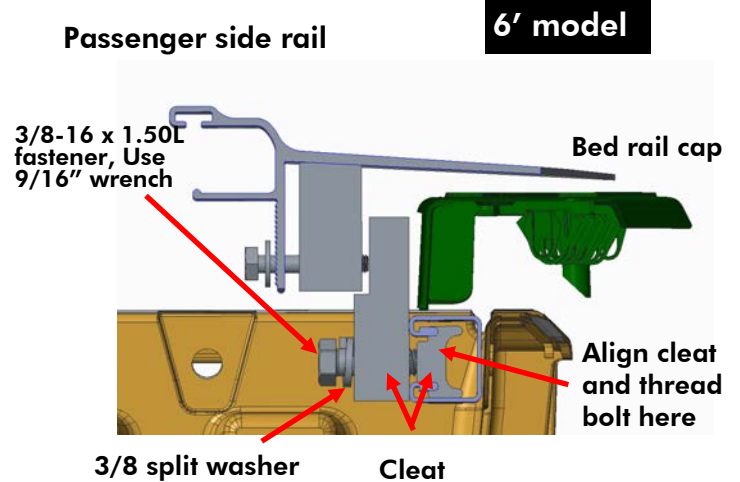
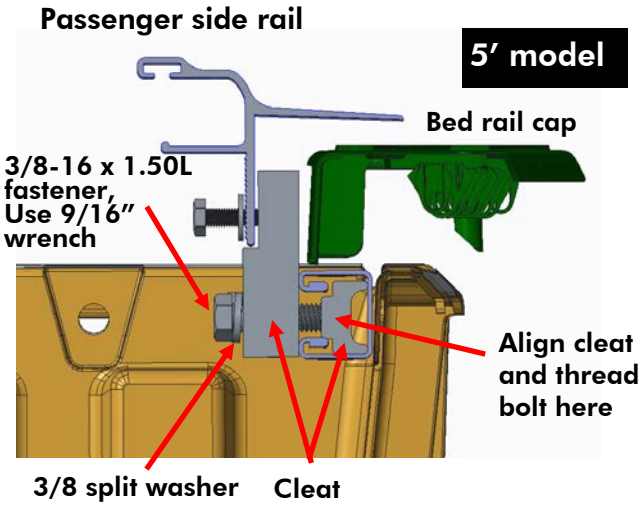

Make certain the rails are parallel - see page 3 at step 6. If not, see adjustments below.

STEP 5: Adjust rails to maintain parallel rails

If rails are too far apart add 0.050 shim between rail and aluminum spacer . Continue adjustment until rails are parallel. Shim is circled in red.

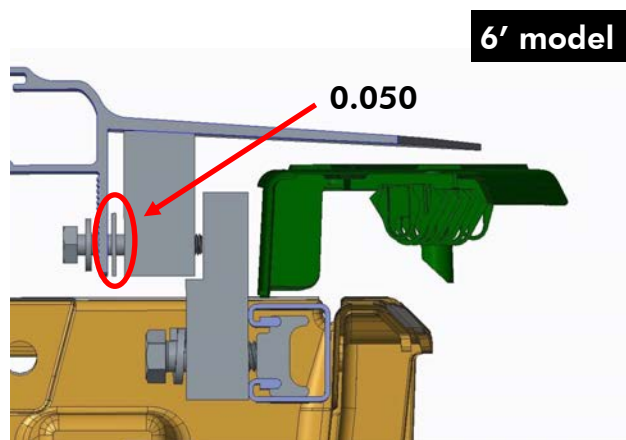
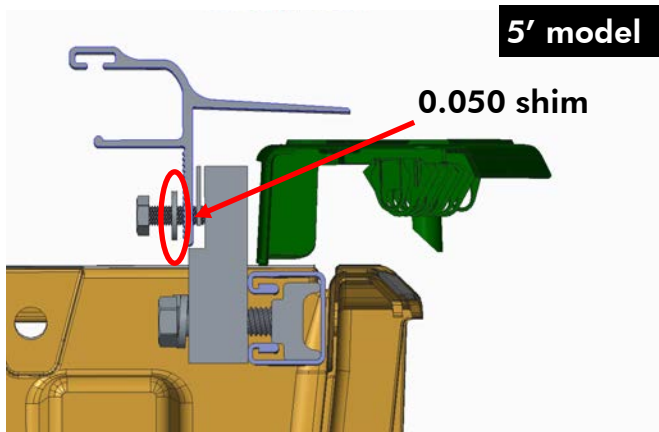

← Continue with standard instructions at step 8 (pg. 4)

Toyota Tundra 2007-up w/ Deck Rail System

Check the parts shown here, this model has different requirements than the standard parts.

Follow standard instructions through step 3, (pg. 2) then refer back to this guide on how to install mounting hardware.

STEP 1: Remove plastic caps

Remove and save the black plastic cap at the rear of the Deck Rail track system on both sides of the truck. Loosen and slide out the movable truck tie downs on each side of the bed.

STEP 3: Re-insert tie downs and 2nd cleat

Re-insert the tie down clamps on each side of the bed, before inserting 2nd cleat. After putting tie downs back into bed, insert 2nd mounting cleat into track system on each side, positioning it approximately 8" from tailgate. Finish by re-inserting the black plastic cap into the rear of the track system.

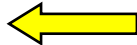

Continue with the standard instructions at step 4 (pg. 2)

FOR STEP 5 ON STANDARD INSTRUCTIONS:

This photo shows how the clamp will mount to the rail. It is **important** to be sure that the threaded hole on the cleat is closest to the bottom of the C-Channel.

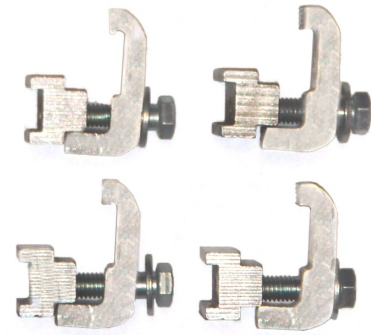
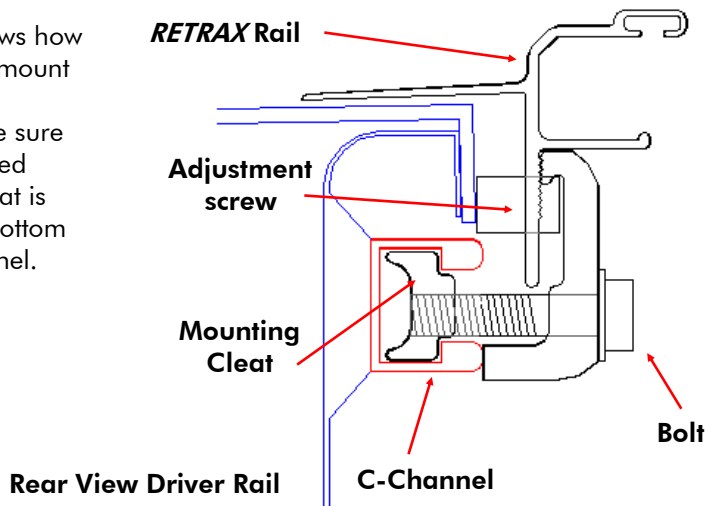

STEP 2: Insert mounting cleats

Insert 1 mounting cleat into the track system on each side, position it about 15" from the front of the bed.





917 South 46th Street
Grand Forks, ND 58201
P: (701) 746-5596 F: 746-5598
www.retrax.com
retrax@retrax.com
1-800-206-4070

