



LEGAL IN CALIFORNIA ONLY FOR RACING VEHICLES WHICH MAY NEVER BE USED, REGISTERED OR LICENSED FOR USE UPON A HIGHWAY. See knfilters.com for CARB status on each part for a specific vehicle

INSTALLATION INSTRUCTIONS

77-1578KP
RAM
2019-21 Ram 1500
V8-5.7L

NOTE: This kit was not designed to fit vehicles with a body lift.

TOOLS NEEDED:

- flat blade screw driver
- 4mm allen

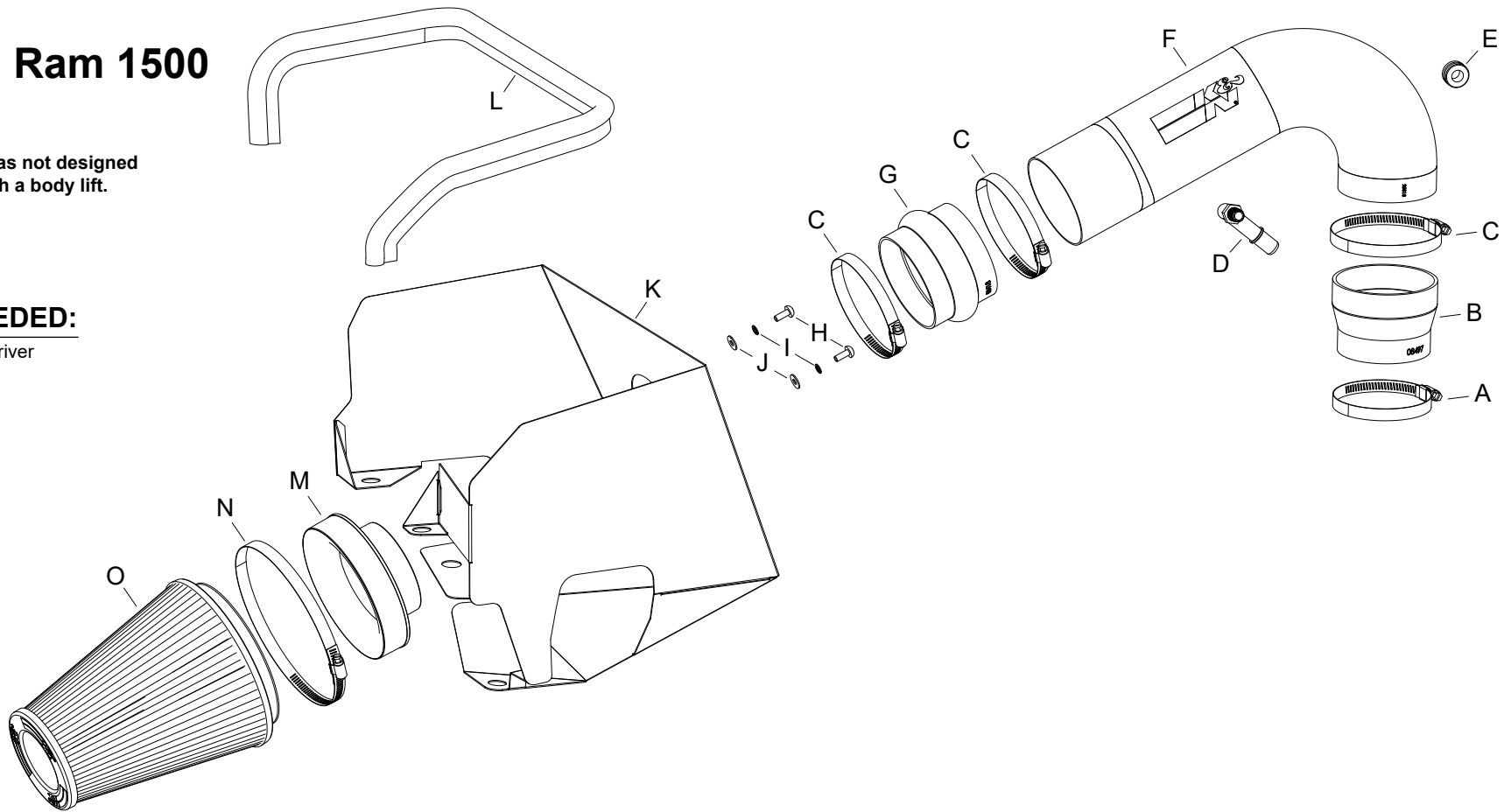

PARTS LIST:

Description	Qty.	Part #	Description	Qty.	Part #	Description	Qty.	Part #
A HOSE CLAMP #56	1	08620	F INTAKE TUBE	1	25813P	K HEAT SHIELD	1	073274
B HOSE; 4"ID TO 3.5"ID X 3"L	1	08497	G HOSE; HUMP 4"ID X 3"L REIN.	1	08418	L EDGE TRIM (44")	1	102486A
C HOSE CLAMP #64 STAINLESS	3	08645	H BOLT; M6 X 1.00" 12MM, SS	2	07794	M ADAPTOR; 57-3058 #454	1	27300
D VENT; 90"D, 1/4"NPT QUICK	1	088028	I WASHER, M6 SPLIT LOCK ZINC	2	1-3025	N HOSE CLAMP; #104	1	08697
E GROMMET; 1"OD, 1/2"ID, 1/2"	1	08064	J WASHER; 1/4"ID X 5/8"OD	2	08275	O FILTER	1	RC-50460

If you need any assistance please call 1-800-858-3333 to speak with a representative in our Customer Service Center before returning the product.

NOTE: FAILURE TO FOLLOW INSTALLATION INSTRUCTIONS AND NOT USING THE PROVIDED HARDWARE MAY DAMAGE THE INTAKE TUBE, THROTTLE BODY AND ENGINE.

TO START:

1. Turn off the ignition and disconnect the negative battery cable.
NOTE: Disconnecting the negative battery cable erases pre-programmed electronic memories. Write down all memory settings before disconnecting the negative battery cable. Some radios will require an anti-theft code to be entered after the battery is reconnected. The anti-theft code is typically supplied with your owner's manual. In the event your vehicles anti-theft code cannot be recovered, contact an authorized dealership to obtain your vehicles anti-theft code.



2. Disconnect the inlet air temperature sensor electrical connection and crank case vent line from the factory intake tube.



3. Loosen the hose clamp at the throttle body and then lift the complete intake system out of the vehicle.
NOTE: K&N Engineering, Inc., recommends that customers do not discard factory air intake.



4. Install the provided edge trim onto the heat shield as shown.
NOTE: Some trimming of the edge trim will be necessary.



5. Install the provided filter adapter into the heat shield and secure with the provided hardware.

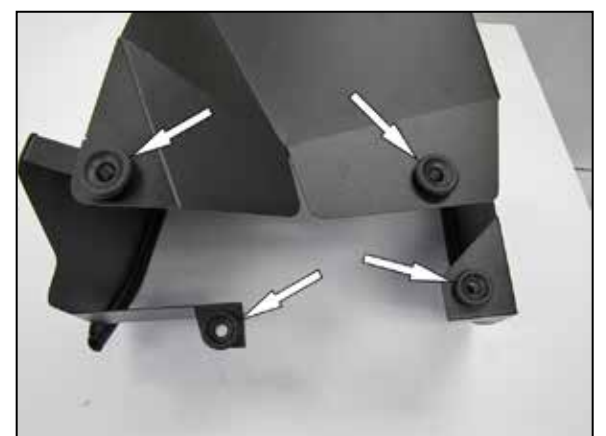

6. Remove the four mounting grommets from the factory air filter housing and install them into the heat shield as shown.

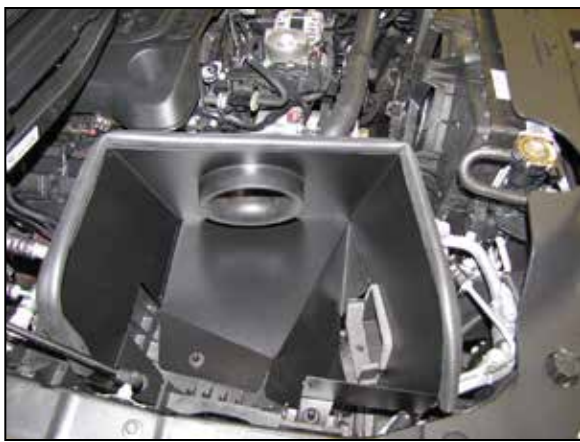

7. Install the heat shield into position as shown.



8. Install the provided coupler (08497) onto the throttle body and secure with the provided hose clamp.



9. Install the provided coupler (08418) onto the filter adapter and secure with the provided hose clamp.



10. Remove the inlet air temperature sensor from the factory intake tube and remove the O-ring from the sensor.



11. Install the inlet air temperature sensor into the K&N® intake tube using the provided grommet. Install the 90° NPT fitting onto the K&N® intake tube as shown.

NOTE: Plastic NPT fittings are easy to cross thread. Install the vent fitting "hand" tight, then turn it two complete turns with a wrench.



12. Install the K&N® intake tube into the coupler at the heat shield and then into the coupler on the throttle body, adjust the tube for best fit and then secure with the provided hose clamps.



13. Connect the crank case vent line and inlet air temperature sensor electrical connection.

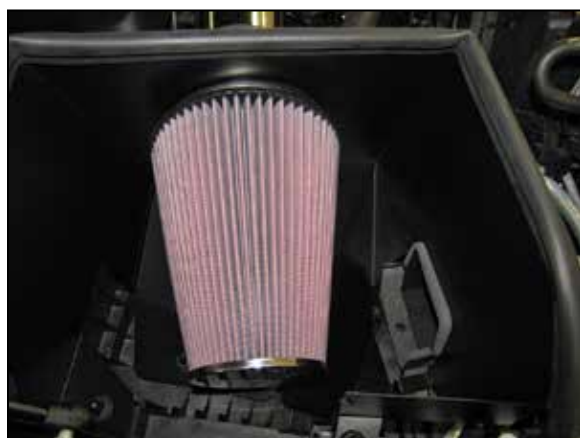

14. Install the K&N® air filter and secure with the provided hose clamp.



15. Reconnect the vehicle's negative battery cable. Double check to make sure everything is tight and properly positioned before starting the vehicle.

16. It will be necessary for all K&N® high flow intake systems to be checked periodically for realignment, clearance and tightening of all connections. Failure to follow the above instructions or proper maintenance may void warranty.

ROAD TESTING:

1. Start the engine with the transmission in neutral or park, and the parking brake engaged. Listen for air leaks or odd noises. For air leaks secure hoses and connections. For odd noises, find cause and repair before proceeding. This kit will function identically to the factory system except for being louder and much more responsive.

2. Test drive the vehicle. Listen for odd noises or rattles and fix as necessary.

3. If road test is fine, you can now enjoy the added power and performance from your kit.

4. K&N Engineering, Inc., requires cleaning the intake system's air filter element every 100,000 miles. When used in dusty or off-road environments, our filters will require cleaning more often. We recommend that you visually inspect your filter once every 25,000 miles to determine if the screen is still visible. When the screen is no longer visible some place on the filter element, it is time to clean it. To clean and re-oil, purchase our filter Recharger® service kit, part number 99-5050 or 99-5000 and follow the easy instructions.

LEGAL IN CALIFORNIA ONLY FOR RACING VEHICLES WHICH MAY NEVER BE USED, REGISTERED OR LICENSED FOR USE UPON A HIGHWAY.

See knfilters.com for CARB status on each part for a specific vehicle