

REDROCK

5" WTW SIDEBARS
19-23 RAM 1500 QUAD CAB 6.5FT BED
(EXCL. 19-23 RAM 1500 CLASSIC)
SKU: R151840 / R151841

PARTS LIST:

1	Driver/left Side 5in WTW Sidebar	1	Passenger/right Side Rear Support Bracket
1	Passenger/right Side 5in WTW Sidebar	2	8-1.25mm x 30mm Hex Bolts
4	Front & Center Brackets (use left or right)	12	8mm x 25mm Combo Bolts
1	Driver/left Side Rear Bracket	22	8mm x 24mm x 2mm Flat Washers
1	Passenger/right Side Rear Bracket	20	8mm Nylon Lock Nuts
1	Driver/left Side Rear Support Bracket		

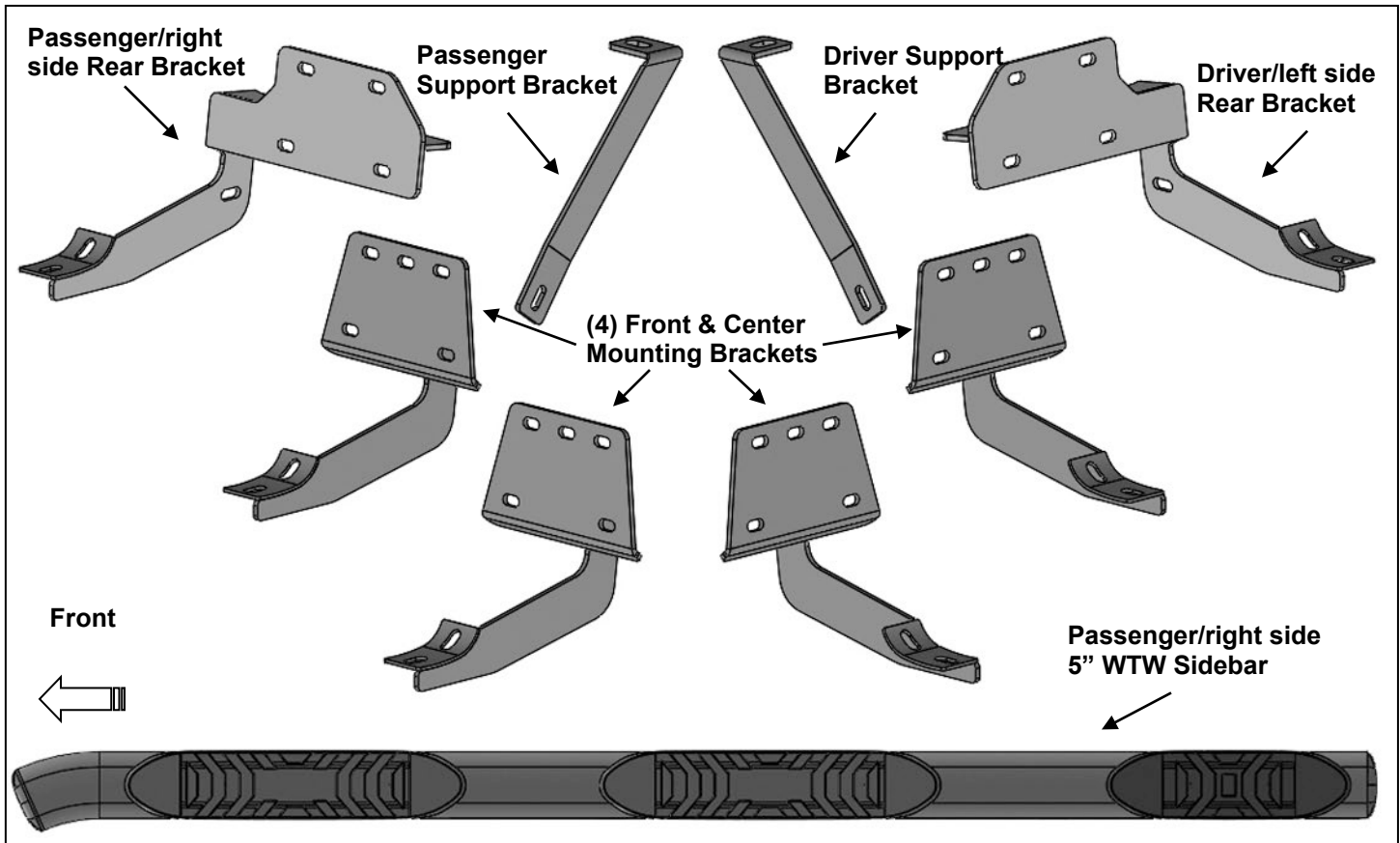

PROCEDURE:

REMOVE CONTENTS FROM BOX. VERIFY ALL PARTS ARE PRESENT. READ INSTRUCTIONS CAREFULLY BEFORE STARTING INSTALLATION. ASSISTANCE IS RECOMMENDED.

1. Start the installation under the passenger side of the vehicle. Locate the front (3) factory studs along the inner side of the body panel, **(Figure 1)**. **NOTE:** Use a wire brush or die to remove paint buildup on the threaded studs.
2. Select (1) Front & Center Bracket. **NOTE:** There are (4) Front & Center Brackets that will fit left or right side. Attach the Mounting Bracket to the (3) factory studs with (3) 8mm Flat Washers and (3) 8mm Nylon Lock Nuts, **(Figure 2)**. Leave brackets loose at this time.
3. Move to the center mounting location, **(Figure 3)**. Repeat **Steps 1 & 2** to install (1) Front/Center Bracket in the center mounting location.
4. Move to the rear mounting location, **(Figure 4)**. Select the Passenger/right side Rear Bracket. **NOTE:** Each Rear Bracket is unique. When installed properly, the Rear Bracket flanges will face towards the rear. See illustration above to help identify the correct Bracket.
5. Repeat **Steps 1 & 2** to install the Passenger/right side Rear Bracket in the rear mounting location, **(Figure 5)**.
6. Next, select the Passenger/right side Support Bracket. Use the illustration above and **Figure 6** to help determine the correct Support Bracket for each side.

7. Temporarily, remove the rear body bolt from the body mount, (**Figure 4**). Reuse the factory body bolt to attach the top end of the Support Bracket to the body mount, (**Figure 7**).
8. Next, attach the bottom end of the Support Bracket to the front side of the Rear Bracket with (1) 8mm x 30mm Hex Bolt, (2) 8mm Flat Washers and (1) 8mm Nylon Lock Nut, (**Figures 8 & 9**). Do not tighten hardware at this time.
9. Carefully unwrap and select the Passenger/right Sidebar. Use the illustration above to help identify the correct Sidebar. Place the Sidebar on top of the Brackets. **IMPORTANT:** Do not slide, (front to back or rotate), the Sidebar on the Brackets or damage to the finish on the Sidebar may result.
10. Attach the Sidebar to the Brackets with (6) 8mm Combo Hex Bolts, (**Figures 10—13**). Do not tighten hardware at this time.
11. Level the Sidebar to the vehicle and tighten all hardware at this time.
12. Repeat **Steps 1—11** for Driver/left Sidebar installation.
13. Do periodic inspections of the installation to make sure that all hardware is secure and tight.

To protect your investment: Wax this product after installing. Regular waxing is recommended to add a protective layer over the finish. Do not use any type of polish or wax that may contain abrasives that could damage the finish. Mild soap may be used also to clean the Sidebar.

Passenger/right Side Installation Pictured

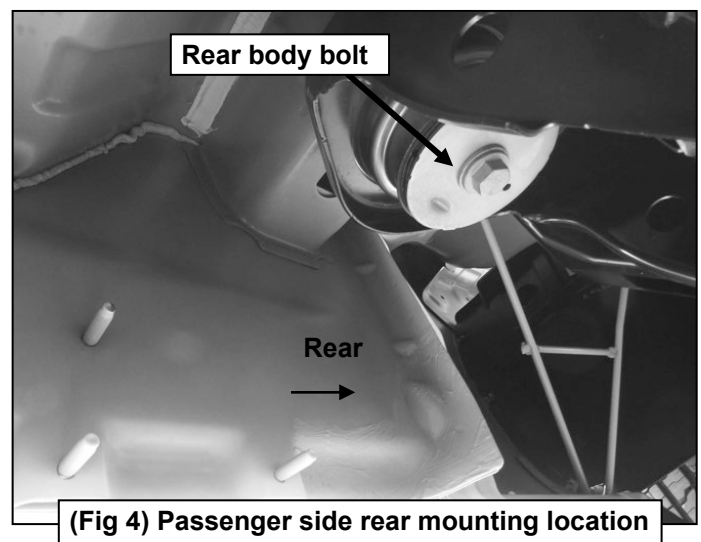
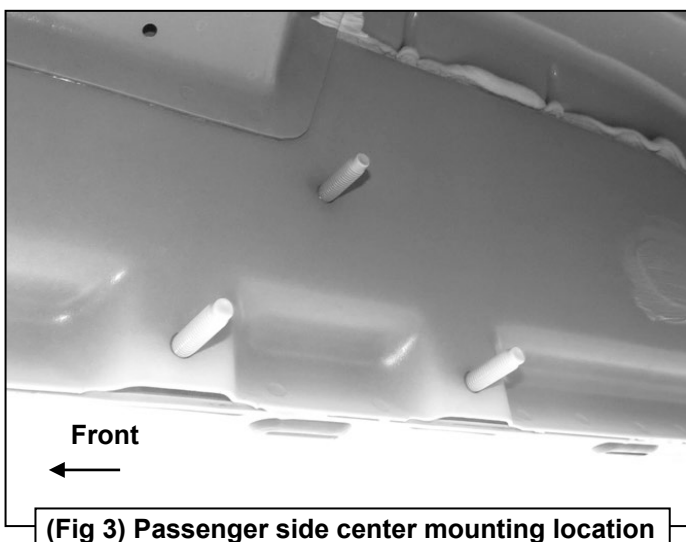
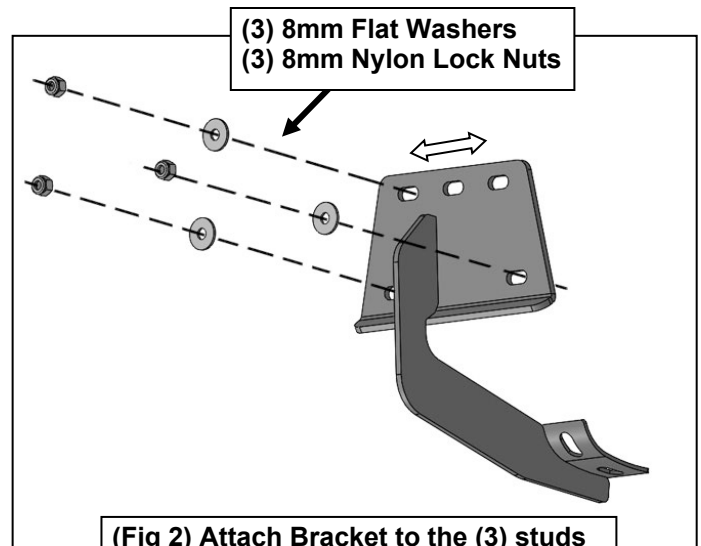
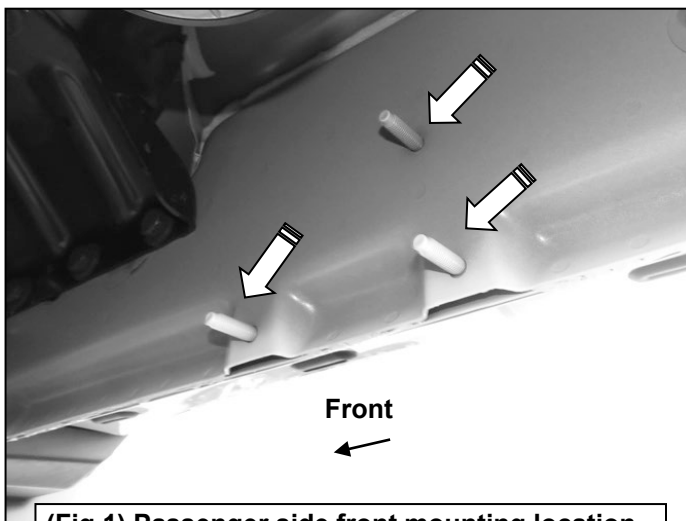

Passenger/right Side Installation Pictured

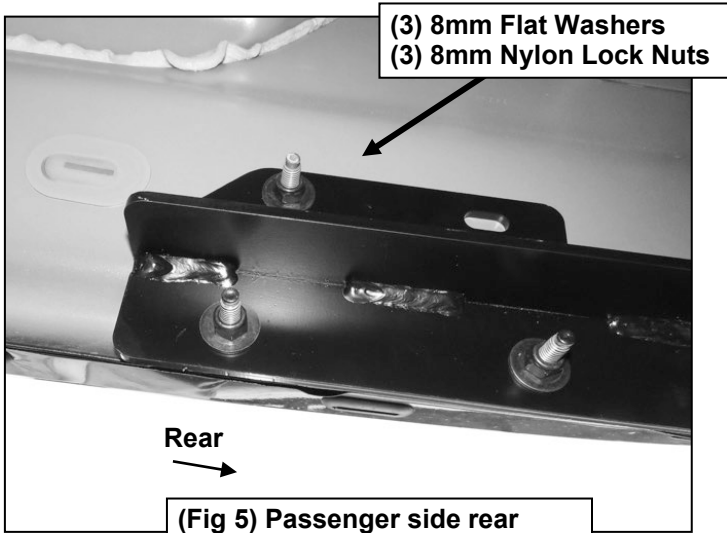

NOTE: Each Rear Bracket is unique. When installed properly, the flanges on the Bracket will face towards the rear.

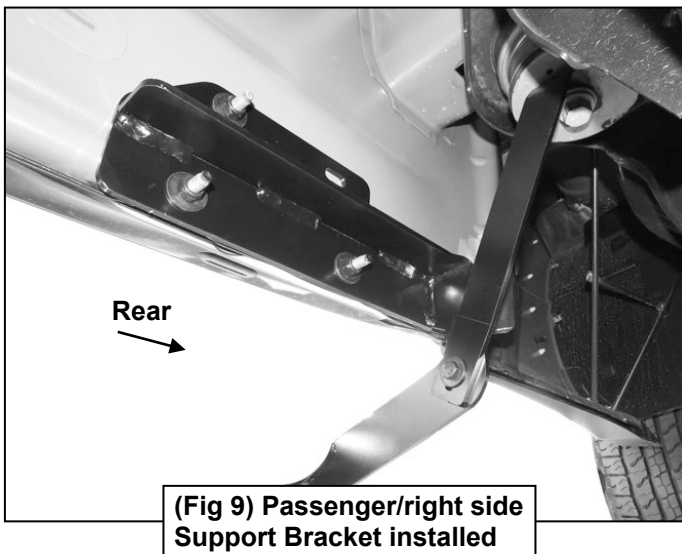
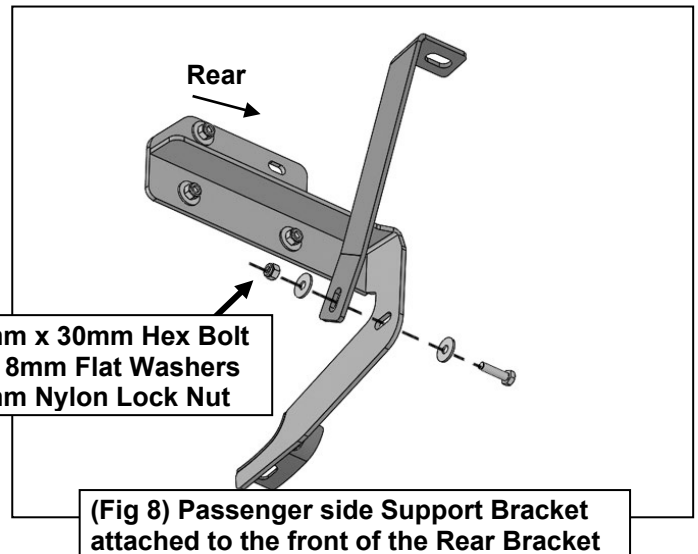
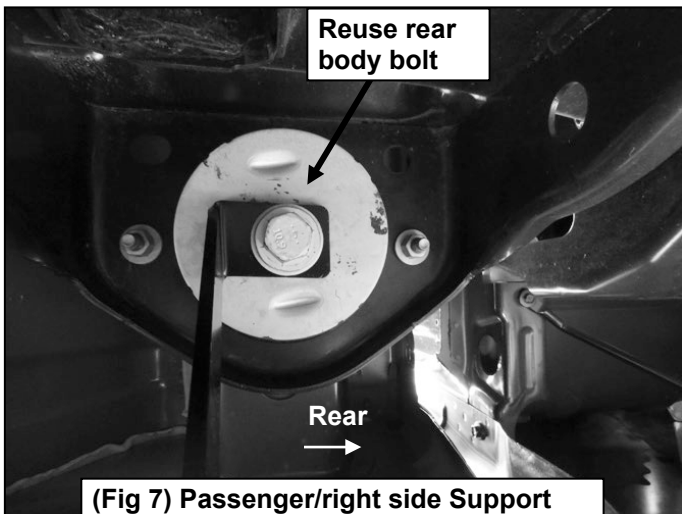
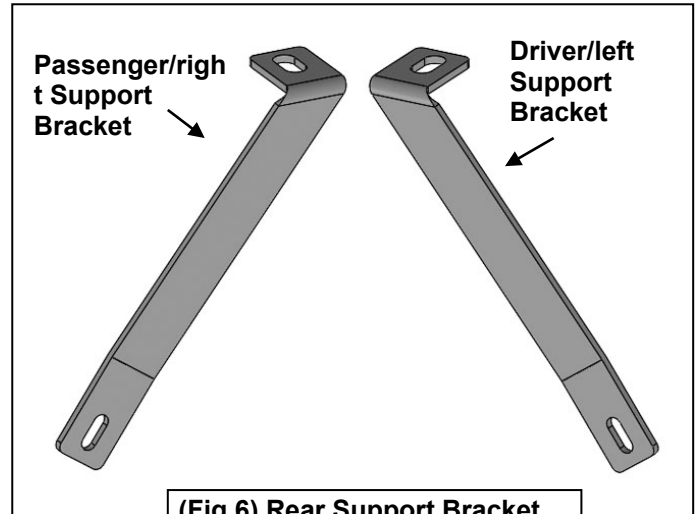

Passenger/right Side Installation Pictured

