

**PARTS LIST:**

1	Driver/left side 6" Oval Straight Sidebar	12	8-1.25mm x 25mm Combo Hex Bolts
1	Passenger/right side 6" Oval Straight Sidebar	18	8mm x 24mm x 2mm Flat Washers
6	Mounting Brackets	18	8-1.25mm Nylon Lock Nuts

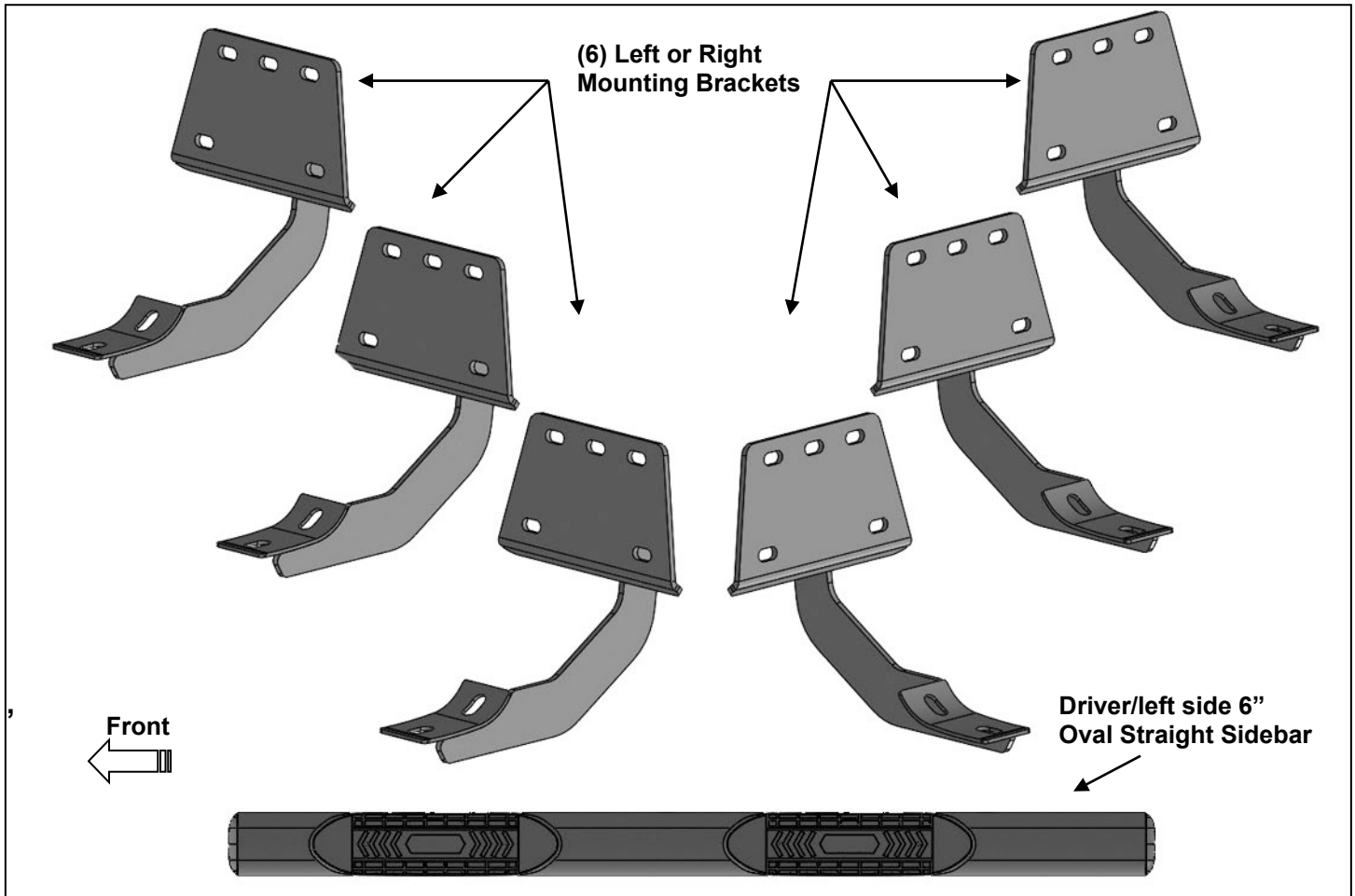

**PROCEDURE:**

**REMOVE CONTENTS FROM BOX. VERIFY ALL PARTS ARE PRESENT. READ INSTRUCTIONS CAREFULLY BEFORE STARTING INSTALLATION. ASSISTANCE IS RECOMMENDED.**

1. Start the installation under the driver's side of the vehicle. Locate the front (3) factory studs along the inner side of the body panel, **(Figure 1)**. **NOTE:** Chase threads on the studs first before installing Brackets to remove paint buildup.
2. Select (1) Mounting Bracket. **NOTE:** All (6) Brackets are universal and will fit left or right side. Attach the Mounting Bracket to the (3) factory studs with (3) 8mm Flat Washers and (3) 8mm Nylon Lock Nuts, **(Figures 2 & 3)**. Leave brackets loose at this time.
3. Repeat **Steps 1 & 2** to install the Universal Brackets in the center and rear mounting locations along the body panel, **(Figures 4—7)**.
4. Carefully unwrap and select the Driver/left Sidebar. Use the illustration above to help identify the correct Sidebar. Place the Sidebar on top of the Brackets. **IMPORTANT:** Do not slide, (front to back or rotate), the Sidebar on the Brackets or damage to the finish on the Sidebar may result.

5. Attach the Sidebar to the Brackets with (6) 8mm Combo Hex Bolts, **(Figures 8—12)**. Do not tighten hardware at this time.
6. Level and adjust the Sidebar as necessary and fully tighten all hardware.
7. Repeat **Steps 1—6** for Passenger/right Sidebar installation.
8. Do periodic inspections of the installation to make sure that all hardware is secure and tight.

**To protect your investment:** Wax this product after installing. Regular waxing is recommended to add a protective layer over the finish. Do not use any type of polish or wax that may contain abrasives that could damage the finish. Mild soap may be used also to clean the Sidebar.

### Driver/left Side Installation Pictured

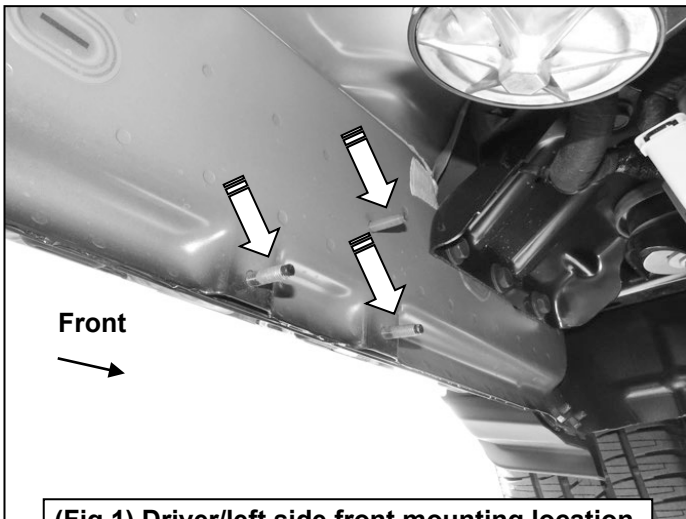

(Fig 1) Driver/left side front mounting location

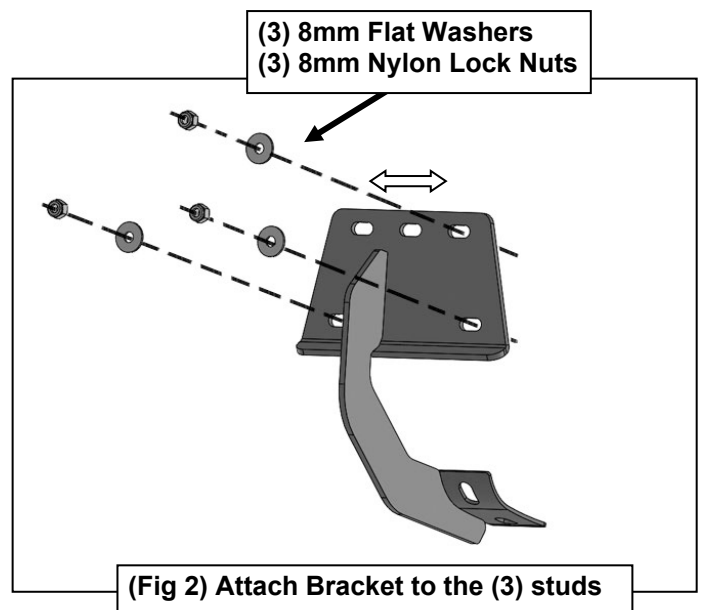

(Fig 2) Attach Bracket to the (3) studs

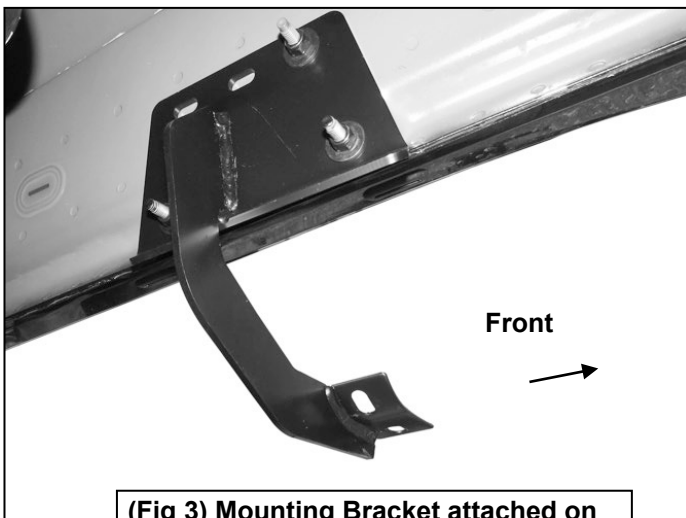

(Fig 3) Mounting Bracket attached on the driver/left front side



(Fig 4) Driver/left side center mounting location

**Driver/left Side Installation Pictured**

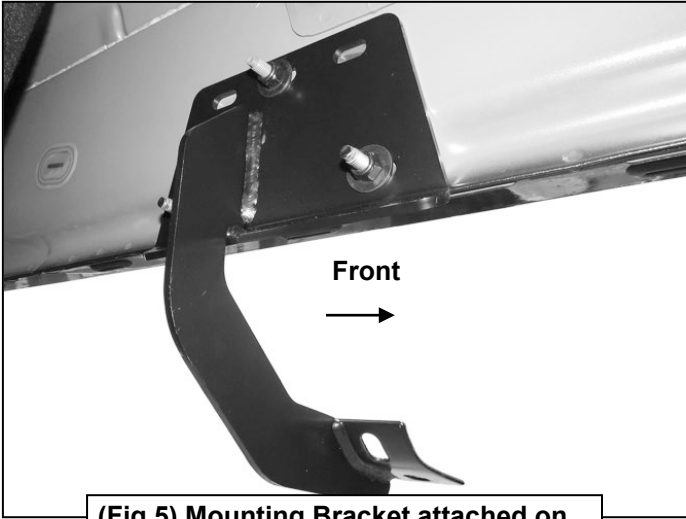

**(Fig 5) Mounting Bracket attached on the driver/left center side**

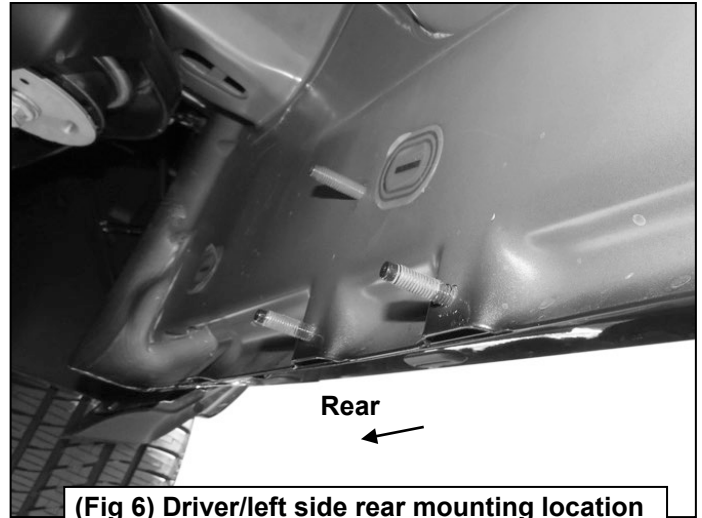

**(Fig 6) Driver/left side rear mounting location**

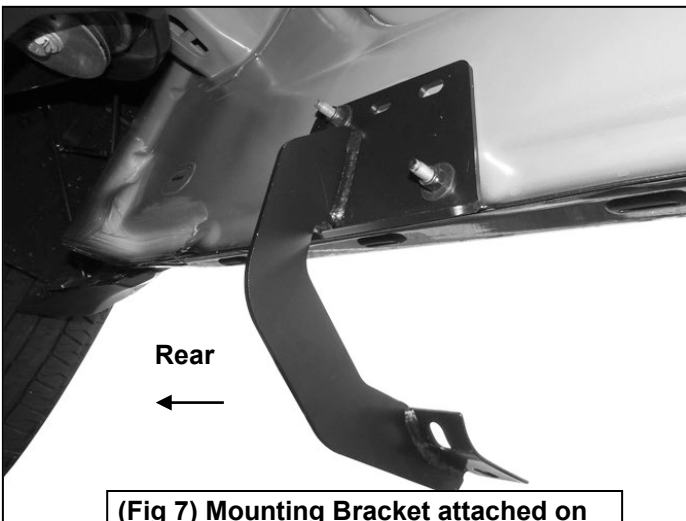

**(Fig 7) Mounting Bracket attached on the driver/left rear side**

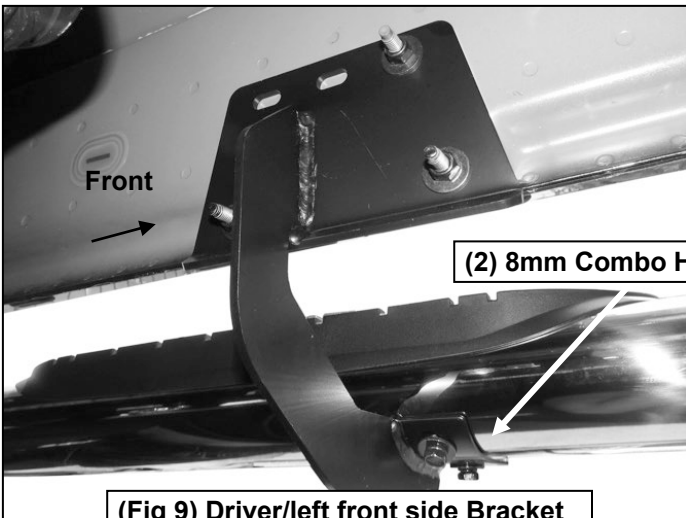

**(Fig 9) Driver/left front side Bracket attached to Sidebar pictured**

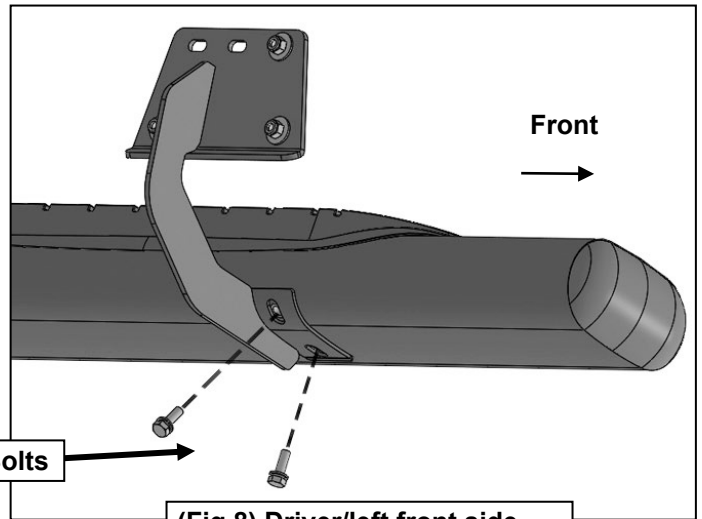

**(Fig 8) Driver/left front side Bracket attached to Sidebar**

**Driver/left Side Installation Pictured**

