

Passenger/right Side Installation Pictured

On models with flat tab (see Fig 3 and 4),
insert 8mm Bolt Plate (Fig 14) down
through Upper Bracket and mounting tab

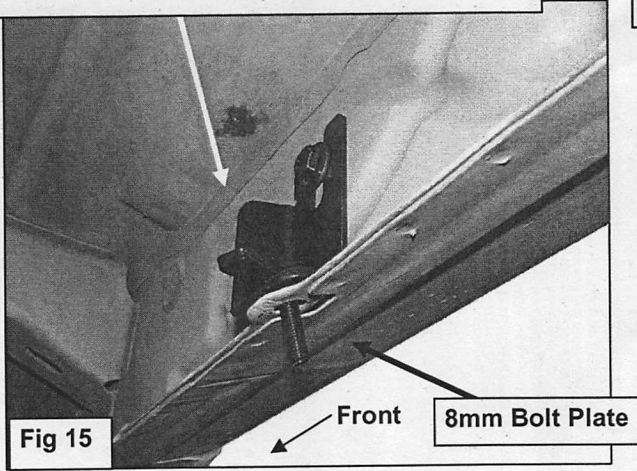

Bracket Cover
(2) Plastic Retainers

8mm x 25mm Hex Bolt
8mm Lock Washer
8mm Flat Washer

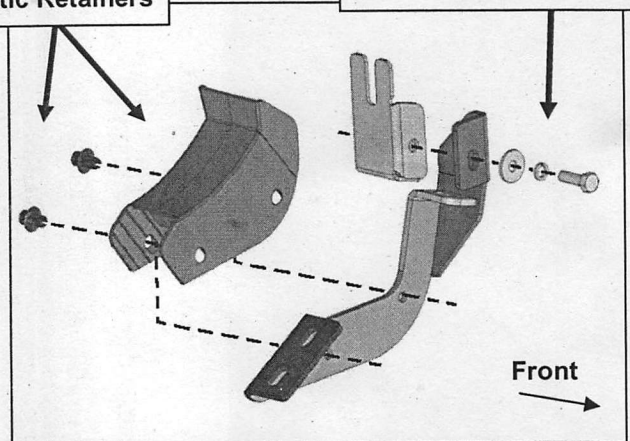

On models with flat tab and 8mm Bolt
Plate (see Fig. 13) use:
8mm Flat Washer
8mm Nylon Lock Nut
to attach Lower Bracket to Bolt Plate

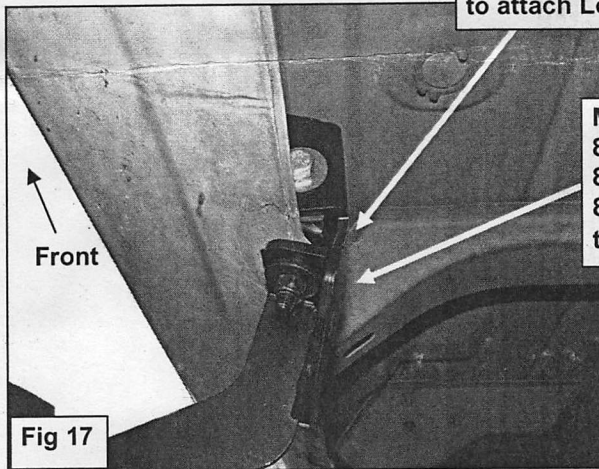

Models with weld nut on tab use:
8mm x 25mm Hex Bolt
8mm Lock Washer
8mm Flat Washer
to attach Lower Bracket to weld nut

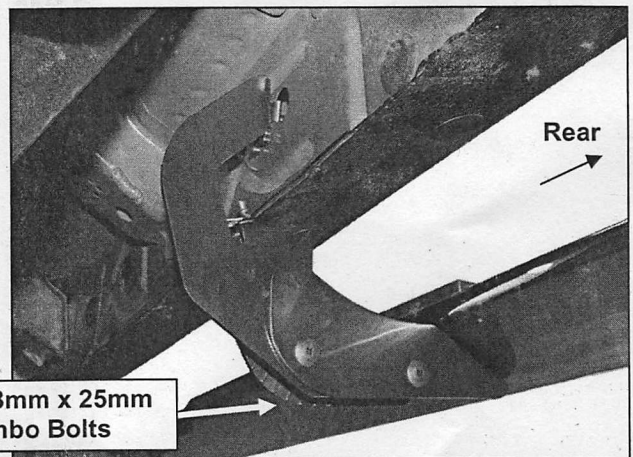

(Fig 18) Passenger/right rear bracket installed

Passenger/right Side Installation Pictured

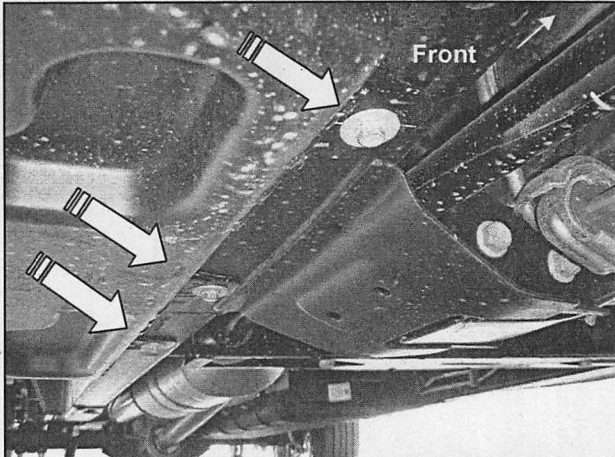

(Fig 10) Passenger side front pictured with DEF tank cover. Remove (3) hex bolts to remove cover

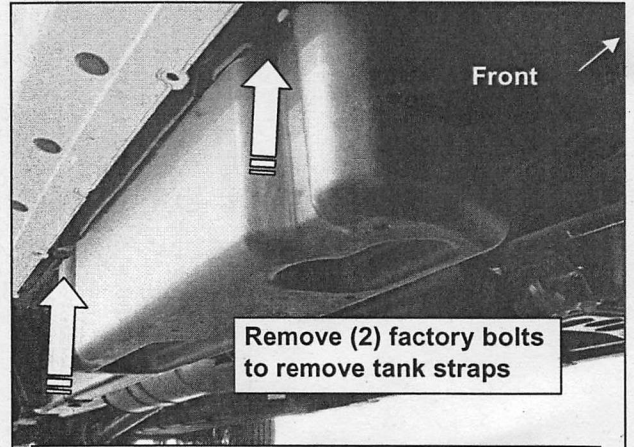

Remove (2) factory bolts to remove tank straps

(Fig 11) Passenger side DEF tank and cover

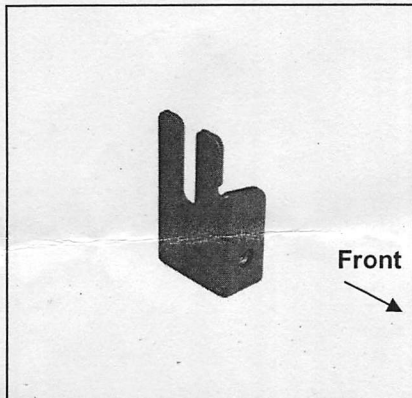

(Fig 12) Passenger/right Front Upper Bracket (all models)

8mm x 25mm Hex Bolt
8mm Lock Washer
8mm Flat Washer

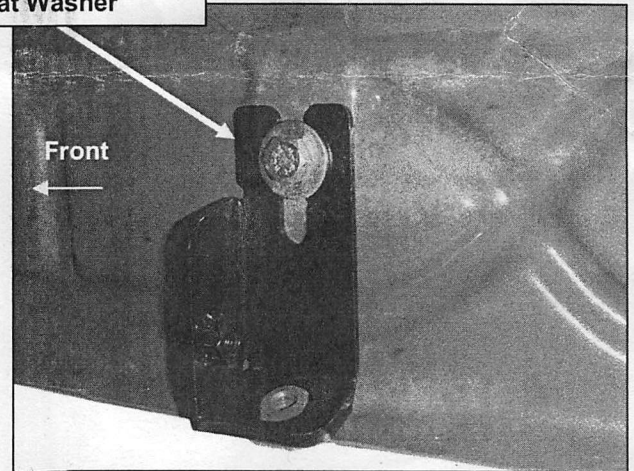

(Fig 13) Slide Upper Bracket over weld nut if equipped-also see Figure 2

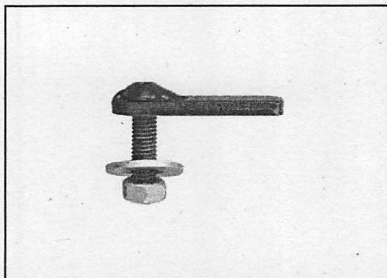

(Fig 14) 8mm x 35mm Bolt Plate

Driver/Left Side Installation Pictured

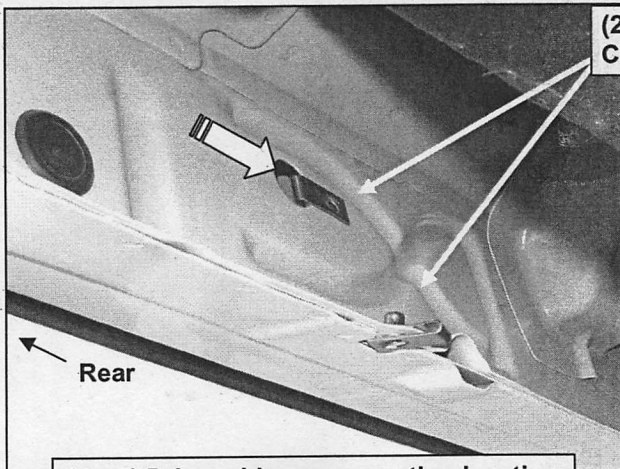

(Fig 5) Driver side rear mounting location

- (2) 8mm x 25mm Hex Bolts
- (2) 8mm Lock Washers
- (2) 8mm Flat Washers

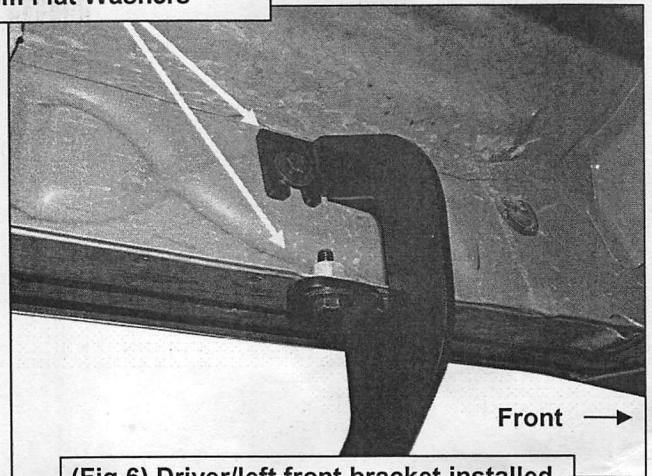

(Fig 6) Driver/left front bracket installed

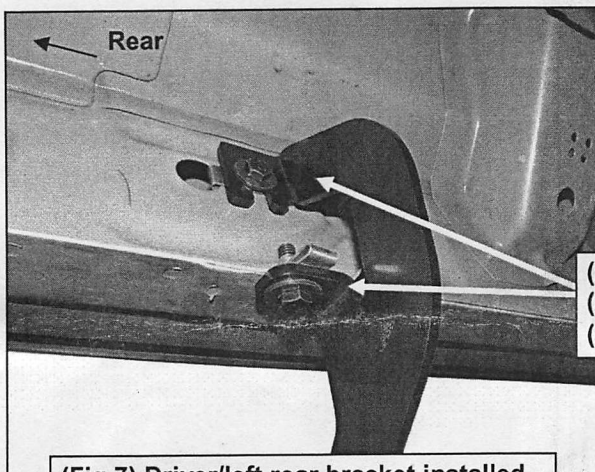

(Fig 7) Driver/left rear bracket installed

- (2) 8mm x 25mm Hex Bolts
- (2) 8mm Lock Washers
- (2) 8mm Flat Washers



(Fig 9) Attach Side Step to Brackets

- (2) 8mm x 25mm Combo Bolts

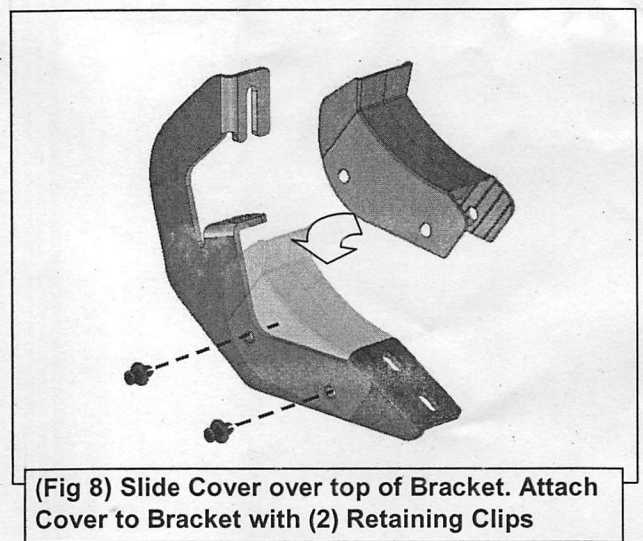

(Fig 8) Slide Cover over top of Bracket. Attach Cover to Bracket with (2) Retaining Clips

To protect your investment, wax this product after installing. Regular waxing is recommended to add a protective layer over the finish. Do not use any type of polish or wax that may contain abrasives that could damage the finish.

For stainless steel: Aluminum polish may be used to polish small scratches and scuffs on the finish. Mild soap may be used also to clean the Side Step.

For gloss black finishes: Mild soap may be used to clean the Side Step.

Driver/Left Side Installation Pictured

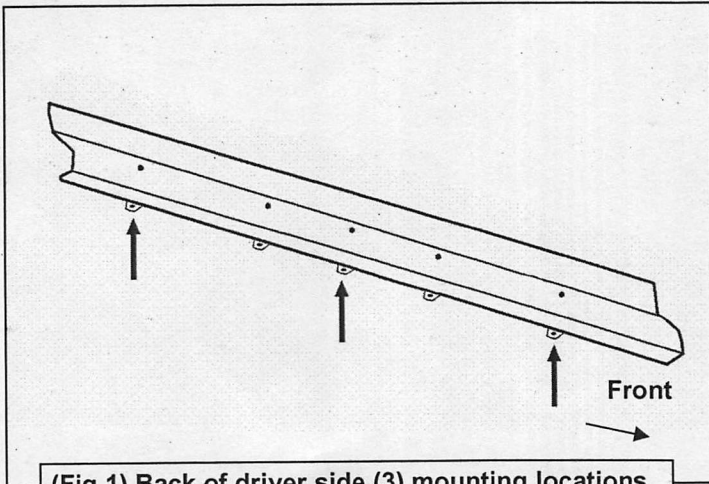

(Fig 1) Back of driver side (3) mounting locations

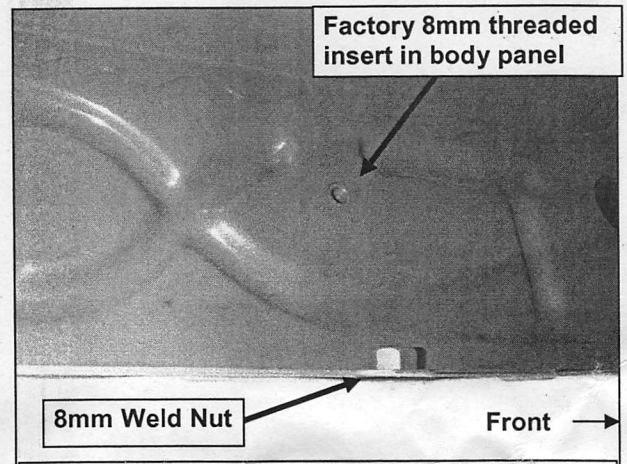

(Fig 2) Passenger side front mounting location

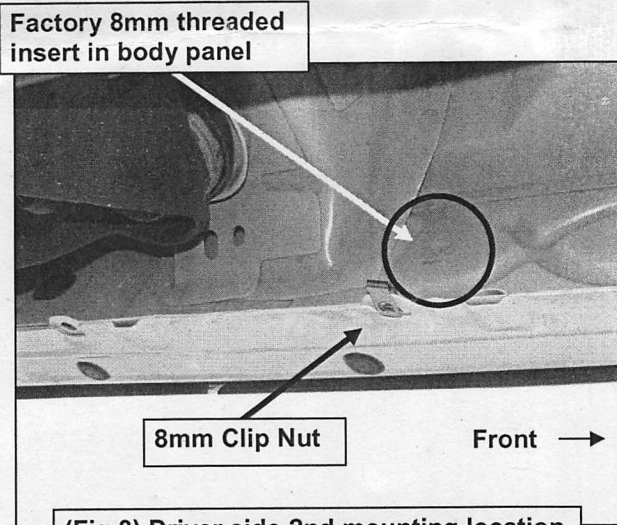

(Fig 3) Driver side 2nd mounting location

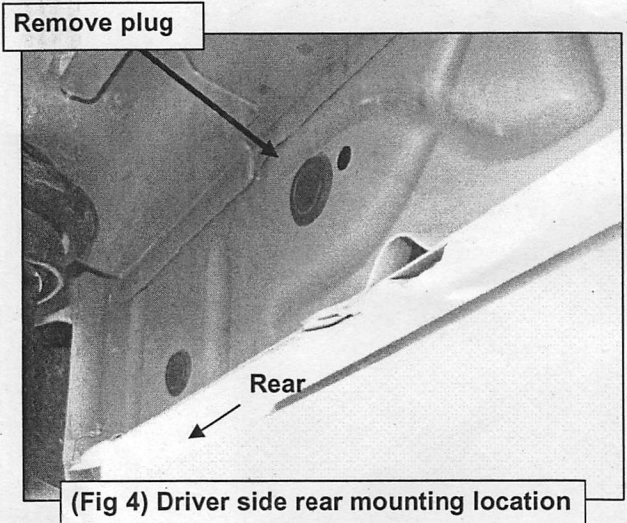

(Fig 4) Driver side rear mounting location

holes with (2) 8mm Hex Bolts, (2) 8mm Lock Washers and (2) 8mm Flat Washers, (Figures 6 & 7). Snug but do not fully tighten the hardware.

4. Repeat Steps 1—3 to install the center and rear driver side Brackets, (Figures 1 & 7).
5. Select (1) Plastic Bracket Cover and (2) Retaining Clips. Slide the Cover over the driver side front Bracket. Line up the (2) mounting holes in the Cover with the holes in the Bracket. Insert the Clip into the holes and push center pin to expand Clip, (Figure 8). Repeat this Step for all Cover installation.
6. Select the driver/left Side Step. Carefully position the Driver Side Step onto the (3) Mounting Brackets. **IMPORTANT:** Do not slide the Side Step on the Brackets or damage to the finish may result. Attach the Side Step to the Mounting Brackets with (6) 8mm x 25mm Combination Hex Bolts, (Figure 9). Do not tighten hardware.
7. Level and adjust the Side Step and fully tighten all hardware.
8. Move to the passenger side of the vehicle. On the passenger side, determine if the vehicle is equipped with a plastic diesel exhaust fluid (DEF) tank, (Figures 10 & 11).

Models without DEF tank, skip to Step 9.

Models with DEF tank: The tank sits close to the side of the body. With specialized tools, the passenger front upper and lower Bracket can be installed but room is limited. It may be easier to drop the tank down to access the inner side of the body panel for upper bracket installation. Tank will not need to be removed, only dropped down for access to mounting location. **IMPORTANT:** If tank is full, it will be very heavy and assistance is highly recommended to avoid injury or damage to the vehicle or the tank. It is recommended that installation is performed when the DEF tank is low on fluid before dropping the tank.

- a. On models with plastic lower tray under the tank, remove the (3) hex bolts attaching the tray to the frame, (Figure 10), and remove the tray.
 - b. Release the tank filler hose. Release the plug for the sending unit on the top of the tank.
 - c. Support the tank with a floor jack. Place a smooth flat surface, (wooden block for example), between the floor jack and the tank to avoid damaging the plastic tank. Do not push up on the tank; only support the weight of the tank with the jack.
 - d. Remove the (2) bolts securing the tank straps to the vehicle, (Figure 11). Tilt the straps to release from the brackets. Slowly lower the tank until the top of the tank is almost visible. Use blocks or stands to support the tank while installing the front Upper and Lower Brackets.
 - e. Proceed to Step 9.
9. Locate the first tab on the edge of the pinch weld on the passenger side, (Figures 2—4, 13 & 15). Select the Upper Bracket, (Figure 12). Repeat Steps 2 & 3 to attach the passenger front Upper Bracket to the side of the body panel, (Figure 13). Do not tighten hardware at this time.
 10. Line up the hole in the bottom of the Upper Bracket with the hole in the tab on the pinch weld.
 - a. **Models with a weld-nut:** Slide the Bracket over the weld-nut, (Figure 13). Attach the Lower Bracket to the bottom of the body and weld-nut with (1) 8mm x 25mm Hex Bolt, (1) 8mm Lock Washer and (1) 8mm Flat Washer, (Figures 16 & 17). Leave loose at this time.
 - b. **Models with flat tab and hole:** Insert the 8mm Bolt Plate down through the hole in the Upper Bracket and mounting tab, (Figures 14 & 15). Attach the Lower Bracket to the bottom of the body and Bolt Plate with (1) 8mm Flat Washer and (1) 8mm Nylon Lock Nut, (Figure 17). Leave loose at this time.
 11. Line up the side tab on the Lower Bracket with the threaded hole in the side of the Upper Bracket. Attach the Lower Bracket to the Upper Bracket with (1) 8mm x 25mm Hex Bolt, (1) 8mm Lock Washer and (1) 8mm Flat Washer, (Figures 16 & 17). Leave loose at this time.
 12. Repeat Steps 1—3 for the (2) remaining passenger side Bracket installations. **NOTE:** Cradles on Brackets installed on passenger side will face forward.
 13. Repeat Steps 5—7 to install the passenger side Covers and Side Step, (Figure 18).
 14. Once the Side Steps are installed and all hardware fully tightened, reinstall the DEF tank and cover, if equipped, as described in Step 8.
 15. Do periodic inspections to the installation to make sure that all hardware is secure and tight.



T4 4" SIDE STEPS
07-15 1500-2500-3500 SILVERADO/SIERRA CREW CAB
INCLUDES DIESEL W/DEF

PARTS LIST: S101571 S101580

1	Driver/left Side Step	11	8-1.25mm Clip-On Nuts
1	Passenger/right Side Step	13	8-1.25mm x 25mm Hex Bolts
1	Passenger/right Front Upper Bracket (all incl. DEF)	13	8mm x 24mm x 2mm Flat Washers
1	Passenger/right Front Lower Bracket (all incl. DEF)	13	8mm Lock Washers
5	4" Sidebar Brackets (use for left or right)	1	8mm Bolt Plate
6	Plastic Bracket Covers	1	8mm Nylon Lock Nut (use w-bolt plate)
12	Retaining Clips (Plastic Covers)	12	8mm x 25mm Combination Bolts

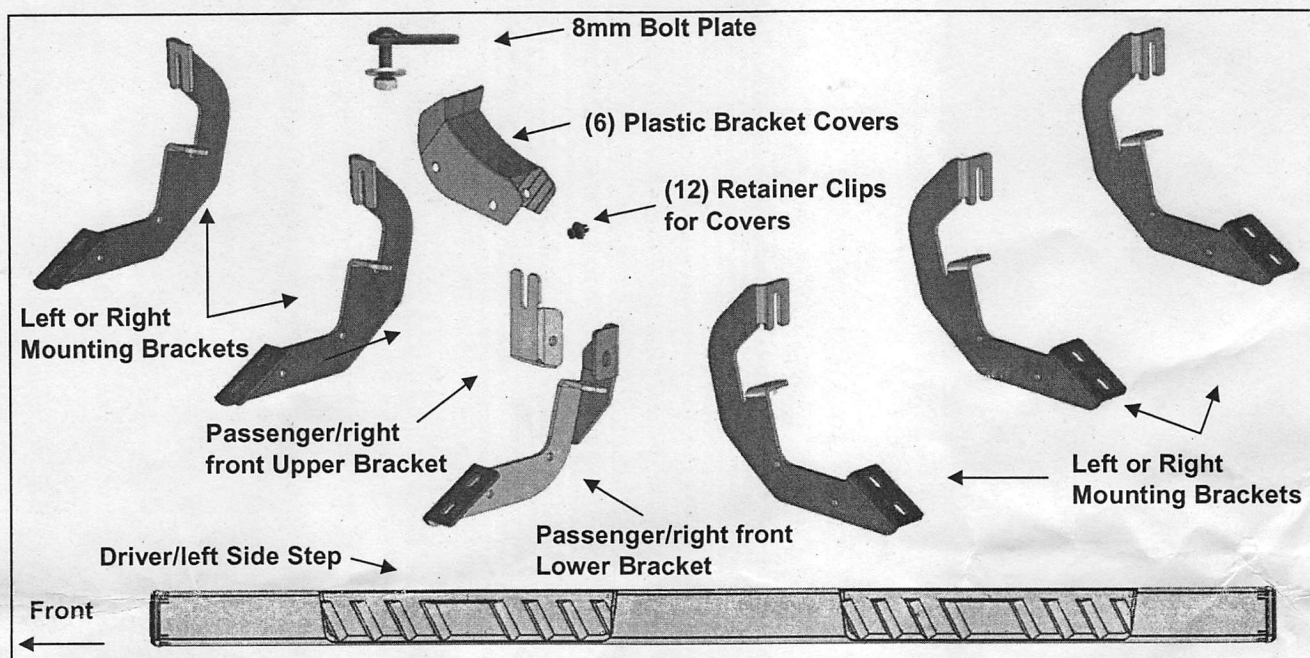

PROCEDURE:

REMOVE CONTENTS FROM BOX. VERIFY ALL PARTS ARE PRESENT. READ INSTRUCTIONS CAREFULLY BEFORE STARTING INSTALLATION. ASSISTANCE IS RECOMMENDED. ON MODELS WITH DEF TANK, SELECT A FLAT, LEVEL AREA FOR INSTALLATION.

1. Start the installation under the driver side of the vehicle. Locate the 5 tabs along the bottom edge of the body, (pinch weld). Mounting Brackets will bolt to the 1st, 3rd, (just in front of center of cab), and 5th mounting tabs, (Figure 1). Directly above each tab is a top mounting location on the side of the body panel. Hold a Bracket up in place to help determine the mounting holes to use along the body.
2. Determine the correct procedure for your model year and each Bracket location.

Bottom mounting location on the edge of the pinch weld.

Flat tab on pinch weld with factory installed weld nut:

Thread hex bolt into weld nut from the backside-down to clear paint from threads, (Figure 2).

Flat tab on pinch weld with hole:

Select (1) 8mm Clip Nut. Slide the Clip Nut over the tab with the nut facing up behind the tab, (Figures 3—5). Line up threaded nut with hole in tab. Repeat for each mounting location.

Top mounting location on the side of the body panel.

Models with factory installed threaded insert in body panel:

Thread 8mm Hex Bolt into threaded insert to clear paint as required, (Figures 2 & 3).

Large and small hole in side of body panel:

Remove the rubber plug from the larger hole, (Figure 4). Select (1) 8mm Clip Nut. Slide the Clip Nut into the larger hole. Line up the threaded nut with the smaller hole, (Figure 5).

3. Select (1) Mounting Bracket. **NOTE:** (5) Brackets are universal and will fit all left side and center and rear only on right side of vehicle. Bolt the Mounting Bracket to the Clip Nuts and/or the factory threaded