



Scan for
Installation Video

STEP 8

Repeat **Step 4** to install the passenger side Step Bar.

STEP 9

Once the Step Bars are installed and all hardware fully tightened, reinstall the DEF tank and cover, if equipped, as described in **Step 5**.

The installation is completed!!!

Attention

Do periodic inspections to the installation to make sure that all hardware is secure and tight.

In order to protect your bars/boards, please use mild soap/non-abrasive products for cleaning only.



STEP 6

Locate the first tab on the edge of the pinch weld, attach the Passenger Front Mounting Bracket to the pinch weld and top body panel (Fig 11 & 12):

- Models with flat tab and hole:** see Fig 11. Leave loose at this time.
- Models with weld-nut:** see Fig 12. Leave loose at this time.

Models With Hole :
 (2) M8 x1.25-25mm Hex Bolts
 (2) M8 Lock Washers
 (2) M8 Large Flat Washers
 (2) M8 Clip Nuts

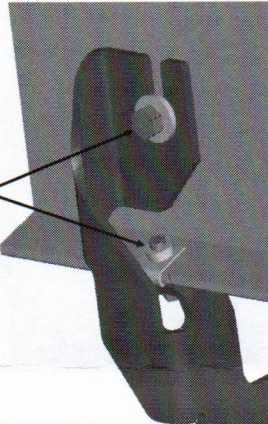

(Fig 11) Passenger Front Mounting Bracket Installed (example)

Models With 8mm Threaded Insert In Body Panel:
 (1) M8 x1.25-25mm Hex Bolt
 (1) M8 Lock Washer
 (1) M8 Large Flat Washer

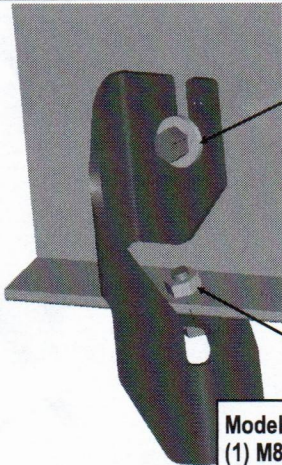

Models With Weld Nut On Pitch Weld:
 (1) M8 x1.25-25mm Hex Bolt
 (1) M8 Lock Washer
 (1) M8 Large Flat Washer

(Fig 12) Passenger Front Mounting Bracket Installation (Weld Nut If Equipped-Also See Fig 2)

STEP 7

Repeat **Steps 2-3** for the passenger side rear mounting bracket installation.

2017-up 2500/3500 DEF tank models: Locate the rear tab bracket location along the bottom edge of the body, (pinch weld), (Fig 13). Hold the DEF cover in place and mark the Rear Bracket location onto the cover, (Fig 14). Use a sharp knife or hacksaw blade to carefully cut a slot in the plastic cover to clear the Rear Bracket, (Fig 15). Remove as little plastic as possible.

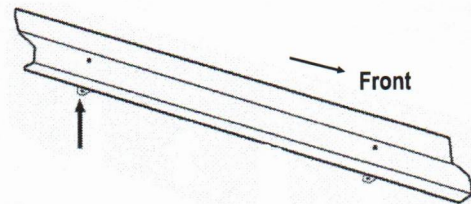

(Fig 13) Passenger Side Rear Mounting Location

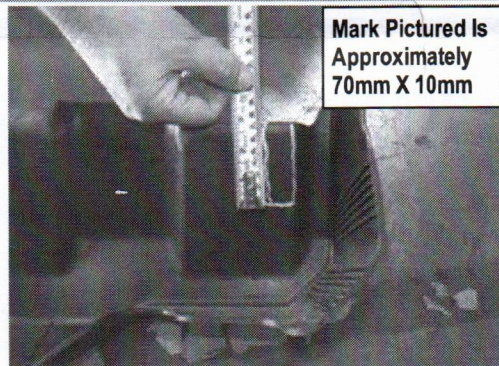

(Fig 14) 2017-Up Passenger Side DEF Cover Marked For Trimming



(Fig 15) 17-Up Passenger Side DEF Cut For Example Only



STEP 5

Move to the passenger side of the vehicle. On the passenger side, determine if the vehicle is equipped with a plastic diesel exhaust fluid (DEF) tank, (Figs 8 & 9).

Models without DEF tank, skip to Step 6.

Models with DEF tank, first determine correct procedure for your model year:

• **2007-2016 Models with DEF tank:**

The tank sits close to the side of the body. With specialized tools, the Passenger Front Mounting Bracket can be installed but room is limited. It may be easier to drop the tank down to access the inner side of the body panel to mount the bracket. Tank will not need to be removed, only dropped down for access to mounting location.

IMPORTANT: If tank is full, it will be very heavy, and assistance is highly recommended to avoid injury or damage to the vehicle or the tank. It is recommended that installation is performed when the DEF tank is low on fluid before dropping down the tank.

a. On models with plastic lower tray under the tank, remove the (3) hex bolts attaching the tray to the frame, (Fig 8), and remove the tray.

b. Release the tank filler hose. Release the plug for the sending unit on the top of the tank.

c. Support the tank with a floor jack. Place a smooth flat surface, (wooden block for example), between the floor jack and the tank to avoid damaging the plastic tank. Do not push up on the tank; only support the weight of the tank with the jack.

d. Remove the (2) bolts securing the tank straps to the vehicle, (Fig 9). Tilt the straps to release from the brackets. Slowly lower the tank until the top of the tank is almost visible. Use blocks or stands to support the tank while installing the Passenger Front Mounting Bracket.

e. Proceed to Step 6.

• **2017-on 2500/3500 models:**

Do not remove the tank. Remove the (4) hex bolts attaching the plastic cover to DEF tank, (Fig 10A) and remove the plastic cover only, (Fig 10B).

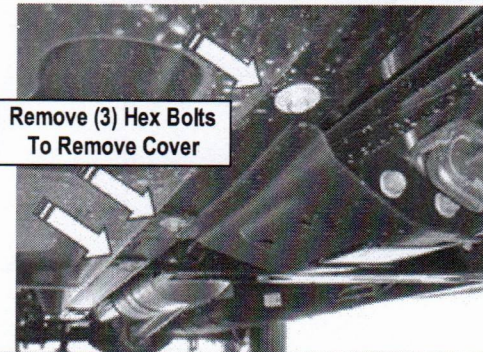

(Fig 8) 07-16 Passenger Side Front With DEF Tank Cover

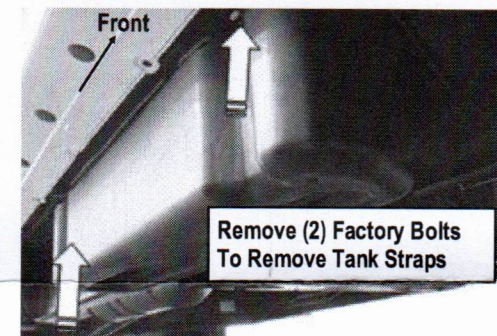

(Fig 9) Passenger side 07-16 DEF tank and cover

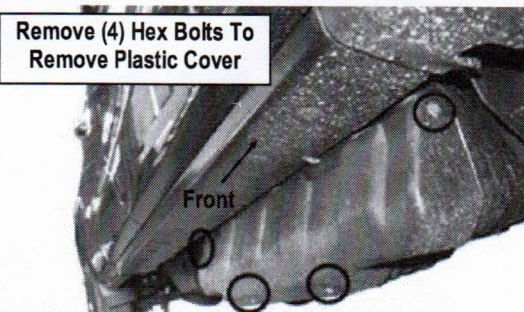

(Fig 10A) 2017-Up Passenger Side Pictured With DEF Plastic Tank Cover.

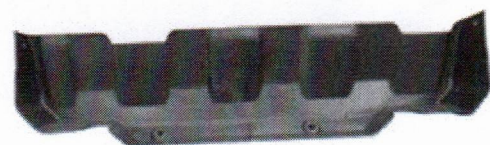

(Fig 10B) 17-on Passenger side DEF cover removed



STEP 3

Select (1) Mounting Bracket, bolt the Mounting Bracket to the installed M8 Clip Nuts and/or the factory threaded holes on Driver Side Front Mounting Location with (2) M8 X1.25-25mm Hex Bolts, (2) M8 Lock Washers and (2) M8 Large Flat Washers, (Fig 5). Do not fully tighten the hardware.

Repeat **Steps 1—3** to install the driver side rear Brackets.

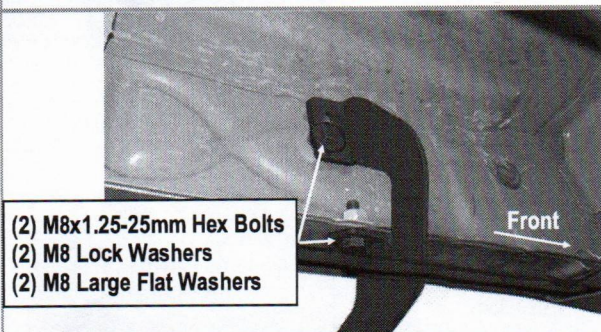

(Fig 5) Driver Front Mounting Bracket Assembly

STEP 4

Once all (2) Driver side mounting brackets are installed, then proceed to the Step Bar installation. (Figs 6 & 7)

- (1) Select (1) Slider and (2) M8X1.25-35mm Carriage Bolts;
- (2) Install (2) M8X1.25-35mm Carriage Bolts in (1) Slider.
- (3) Slide the Slider (with carriage bolts) to the **Step Bar**.
- (4) Repeat to install the other (1) slider to the step bar.
- (5) Attach the Step Bar (with the Sliders) onto the installed mounting brackets. Position the Sliders to the installed brackets. Secure the Step Bar to the installed Brackets by using (4) M8 Large Flat Washers and (4) M8 Nylon Lock Nuts and (2) Sliders, (Fig 7). Do not fully tighten hardware at this time.

Note: The Sliders are packed with the Step Bars.

Level and adjust the Step Bar and fully tighten all hardware.

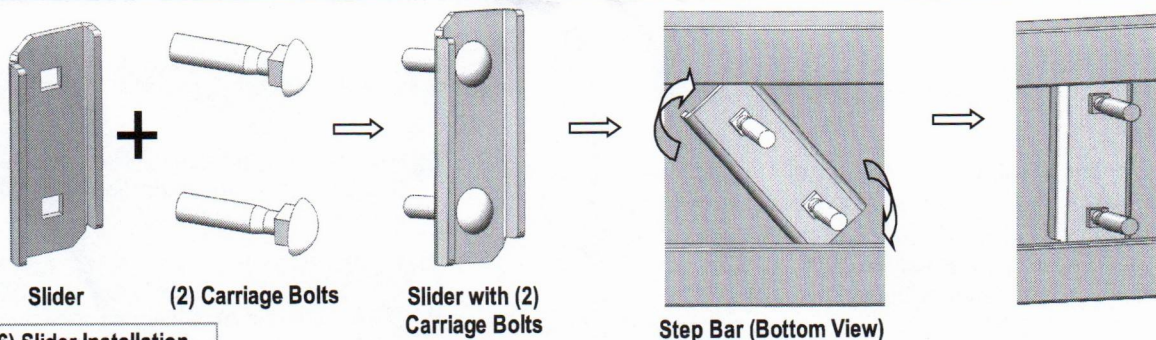

(Fig 6) Slider Installation

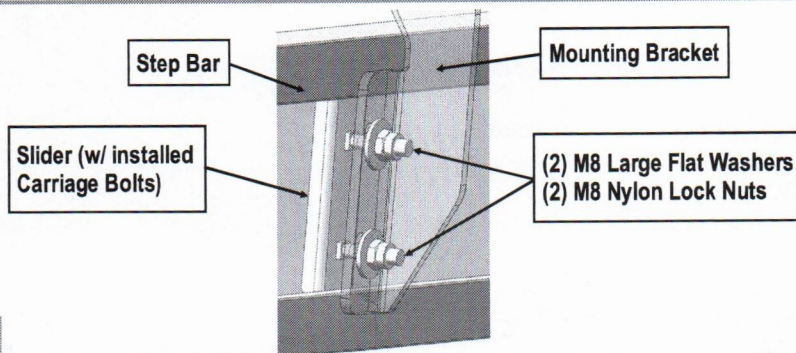

(Fig 7) Step Bar Installation



STEP 1

Start the installation from the driver side of the vehicle. Locate the mounting tabs along the bottom edge of the body, (pinch weld). Mounting brackets will bolt to the mounting tabs. Directly above each tab, there is another top mounting location on the inner side of the body panel. (Fig 1).

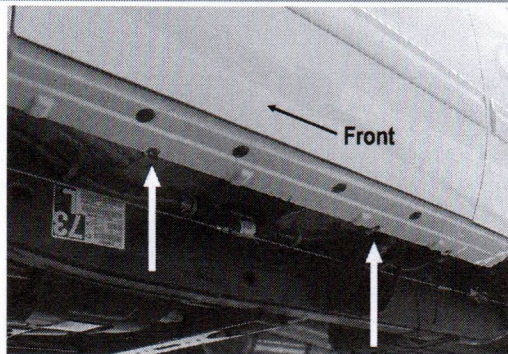

(Fig 1) Driver Side Mounting Locations

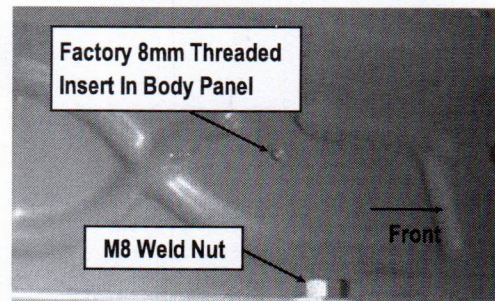

(Fig 2) Driver Front Mounting Bracket Location

STEP 2

Determine the correct procedure for your model year and each Bracket location.

A. Lower mounting location on the edge of the pinch weld

a) **Flat tab on pinch weld with factory installed weld nut**
Thread the M8X1.25-25mm Hex Bolt into the welded nut to clear paint from threads as required, (Fig 2).

b) **Flat tab on pinch weld with hole (Fig 3,4) :**
Select (1) M8 Clip Nut. Slide the Clip Nut over the tab with the nut facing up behind the tab. Repeat this **Step** for Driver Rear mounting location.

B. Upper mounting location on the inner side of the body panel:

a) **Models with factory installed threaded insert in body panel:** Thread M8X1.25-25mm Hex Bolt into the threaded insert to clear paint as required, (Fig 2).

b) **Models with large and small holes on the body panel (Fig 3, 4):**

Remove the rubber plug from the larger hole. Select (1) M8 Clip Nut. Insert the Clip Nut into the larger hole with the thread facing inner side.

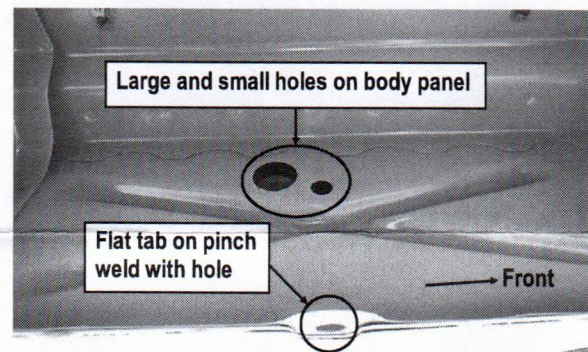

(Fig 3) Driver Side Front Mounting Location
(Flat tab on Pinch Weld with hole)

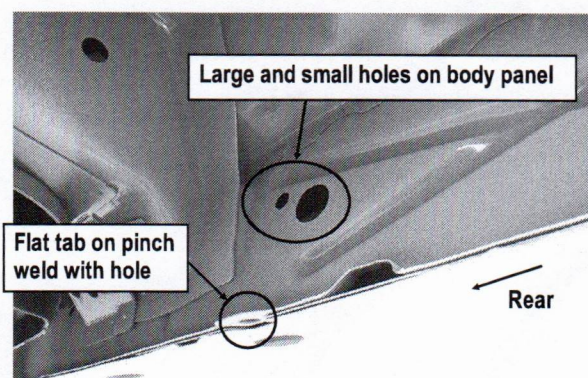

(Fig 4) Driver Side Rear Mounting Location
(Flat tab on Pinch Weld with hole)