

iBoard®



Scan for
Installation Video

iBoard® by APS

PART#: IB-004C&H

READ INSTRUCTIONS CAREFULLY BEFORE STARTING INSTALLATION. REMOVE CONTENTS FROM BOX AND VERIFY ALL PARTS ARE PRESENT. ASSISTANCE IS RECOMMENDED.

*BODY FRAME MOUNT
*NO DRILLING REQUIRED

Fastener Size	Tightening Torque (ft-lbs)	Required
6mm	6-7	X
8mm	16-18	√
10mm	31-32	√
12mm	56-58	X
14mm	92-94	X

PART LIST

Driver Side Step Bar

Front

Passenger Side Step Bar

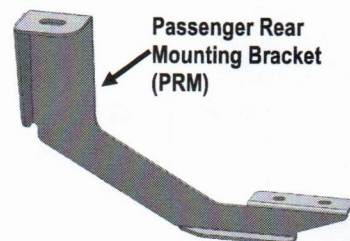
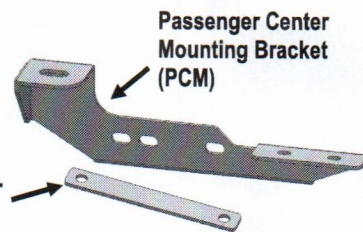
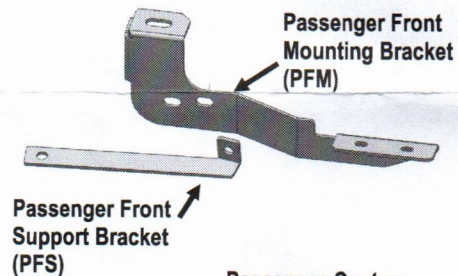
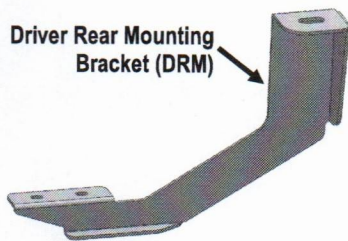
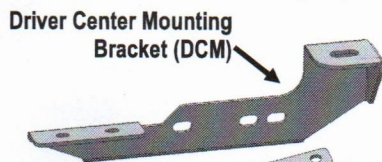
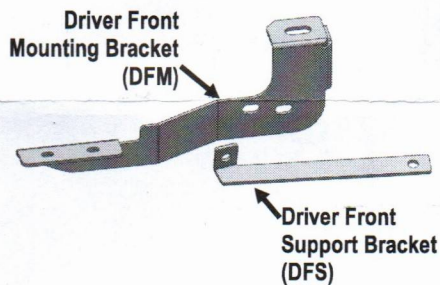

Customer Support: info@iboardauto.com







iBoard®



Scan for
Installation Video





Hardware Package A (For Bracket Installation)

Item	QTY	Description	Item	QTY	Description
1#	2	M10 Nut Plates	4#	10	M10 Flat Washers
2#	8	M10X1.5-30mm Hex Bolts	5#	8	M10 Lock Washers
3#	4	M10 Large Flat Washers	6#	6	M10 Hex Nuts

					
1#	2#	3#	4#	5#	6#

Hardware Package B (For Stainless Steel Step Bar Installation)

Item	QTY	Description	Item	QTY	Description
1#	12	M8X1.25-35mm Carriage Bolts	3#	12	M8 Nylon Lock Nuts
2#	12	M8 Large Flat Washers	4#	6	Sliders (Packed with Step Bars)

			
1 #	2 #	3 #	4 #

Customer Support: info@iboardauto.com

iBoard®



Scan for
Installation Video

STEP 1

Start the installation under the Passenger side of the vehicle. Remove the front body mount bolt, (Fig 1). Do not remove rubber bushings.

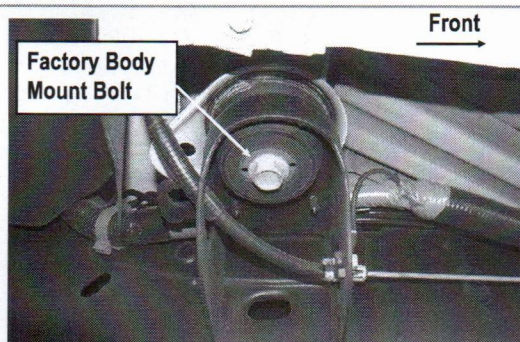

(Fig 1) Passenger Side Front Mounting Location

STEP 2

Attach the Passenger Front Mounting Bracket to the body mount reusing the factory hex bolt, (Fig 2). Do not tighten hardware at this time.

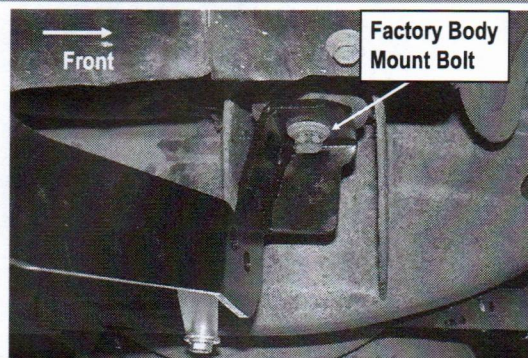

(Fig 2) Passenger Front Mounting Bracket Installed

STEP 3

Locate the two factory holes in the bottom of the frame towards the front of the vehicle, (Fig 3). Insert (1) M10 Nut Plate into the oval hole and line up the threaded nut with the forward

round hole, (Fig 3).

NOTE: Nut Plate and Support Brackets are not required on 2011-Up 2500/3500 models.

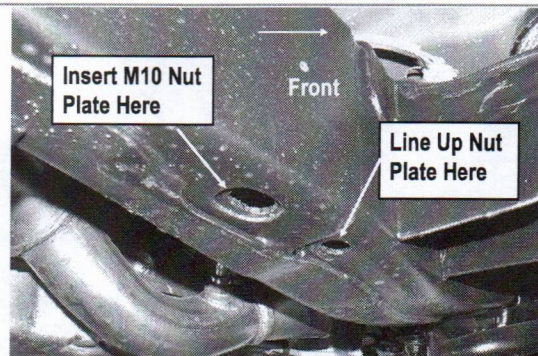

(Fig 3) Passenger Front Support Bracket Mounting Location

STEP 4

Attach the flat end of the Passenger Front Support Bracket to the M10 Nut Plate with (1) M10X1.5-30mm Hex Bolt, (1) M10 Flat Washer and (1) M10 Lock Washer, (Fig 4 & 5). Do not tighten hardware at this time.

1500 Models:

Attach the bent end of the Support Bracket onto the Passenger Front Mounting Bracket with (1) M10X1.5-30mm Hex Bolt, (2) M10 Flat Washers, (1) M10 Lock Washer and (1) M10X1.5 Hex Nut, (Fig 4). Do not tighten hardware at this time.

Up to 2010 2500/3500 Models:

Note that the Front Support Bracket will not reach up to the Mounting Bracket, (Fig 5). Tighten the Support Bracket to the Nut Plate in the frame. Carefully push up on the Support Bracket until it reaches the inside hole in the Mounting Bracket. Bolt the Support Bracket to the hole in the Mounting Bracket with (1) M10X1.5-30mm Hex Bolt, (2) M10 Flat Washers, (1) M10 Lock Washer and (1) M10X1.5 Hex Nut, (Fig 5). Do not tighten at this time.

Note: Support Bracket not required on 2011-Up 2500/3500 Models.

Customer Support: info@iboardauto.com

iBoard®



Scan for
Installation Video

- (1) M10X1.5-30mm Hex Bolt
- (1) M10 Lock Washer
- (1) M10 Flat Washer

- (1) M10X1.5-30mm Hex Bolt
- (2) M10 Flat Washers
- (1) M10 Lock Washer
- (1) M10X1.5 Hex Nut

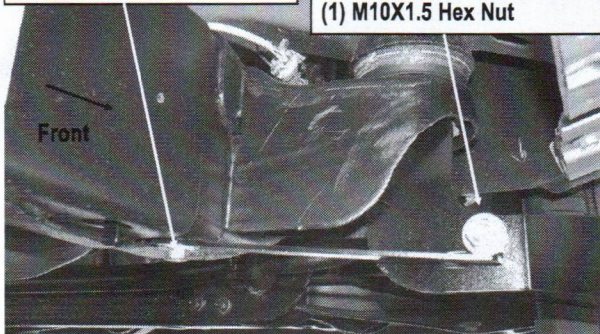

(Fig 4) Passenger Side Front Support Bracket Installed
(1500 Models)

- (1) M10X1.5-30mm Hex Bolt
- (1) M10 Lock Washer
- (1) M10 Flat Washer

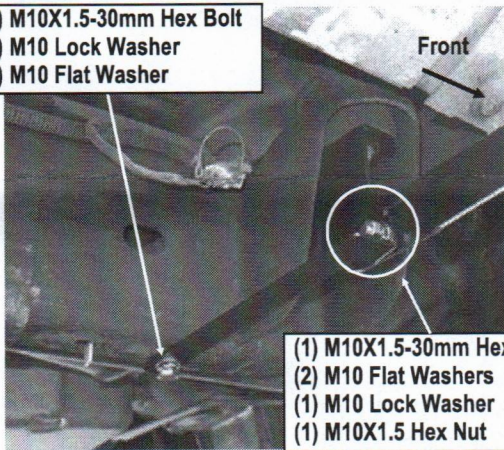

(Fig 5) Passenger Front Support Bracket Installed
(Up to 2011 2500/3500 Models)

STEP 5

Move to the center body mount and remove the factory bolt. Select the Passenger Side Center Mounting Bracket . Repeat **Steps 1 - 2** to attach the Passenger Center Mounting Bracket . Next, select (1) Passenger Center Support Bracket . Slide one end of the Center Support Bracket between the factory body mount and the Center Mounting Bracket, (**Fig 6 & 7**). Attach the Support Bracket to the holes in the side of the body mount and the mounting bracket with (2) M10X1.5-30mm Hex Bolts, (2)

M10 Large Flat Washers, (2) M10 Flat Washers, (2) M10 Lock Washers and (2) M10X1.5 Hex Nuts. Do not tighten at this time.

IMPORTANT: Center Support Brackets are not required on 2011—Up 2500/3500 Models.

- (1) M10X1.5-30mm Hex Bolt
- (2) M10 Flat Washers
- (1) M10 Lock Washer
- (1) M10X1.5 Hex Nut

- (1) M10X1.5-30mm Hex Bolt
- (2) M10 Large Flat Washers
- (1) M10 Lock Washer
- (1) M10X1.5 Hex Nut

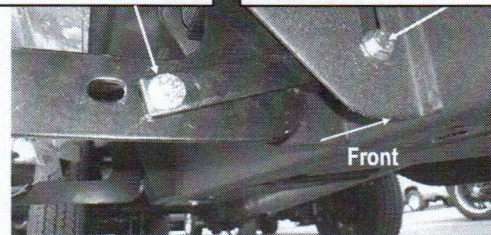

(Fig 6) Passenger Center Bracket Installed (1500 Models)

- (1) M10X1.5-30mm Hex Bolt
- (2) M10 Flat Washers
- (1) M10 Lock Washer
- (1) M10X1.5 Hex Nut

- (1) M10X1.5-30mm Hex Bolt
- (2) M10 Large Flat Washers
- (1) M10 Lock Washer
- (1) M10X1.5 Hex Nut



(Fig 7) Passenger Center Bracket Installed
(Up to 2011 2500/3500 Models)

STEP 6

Move to the rear body mount. Repeat **Steps 1 & 2** to attach Passenger Rear Mounting Bracket (**PRM**) to the body mount, (**Fig 8**). Leave hardware loose at this time.

Customer Support: info@iboardauto.com

iBoard®



Scan for
Installation Video



(Fig 8) Passenger Rear Mounting Bracket Installed

STEP 7

Once all (3) Passenger side mounting brackets are installed, then proceed to the Step Bar installation. (Figs 9 & 10)

- (1) Select (1) Slider and (2) M8X1.25-35mm Carriage Bolts;
- (2) Install (2) M8X1.25-35mm Carriage Bolts in (1) Slider.
- (3) Slide the Slider (with carriage bolts) to the **Step Bar**.

(4) Repeat to install the other (2) sliders to the step bar.

(5) Attach the Step Bar (with the Sliders) onto the installed mounting brackets. Position the Sliders to the installed brackets. Secure the Step Bar to the installed Brackets by using (6) M8 Large Flat Washers and (6) M8 Nylon Lock Nuts and (3) Sliders, (Fig 10). Do not fully tighten hardware at this time.

Note: The Sliders are packed with the Step Bars.

Level and adjust the Step Bar and fully tighten all hardware.

Repeat **Steps 1-7** for the other side Step Bar installation. **The installation is completed!!!**

Attention

Do periodic inspections to the installation to make sure that all hardware is secure and tight.

In order to protect your bars/boards, please use mild soap/non-abrasive products for cleaning only.

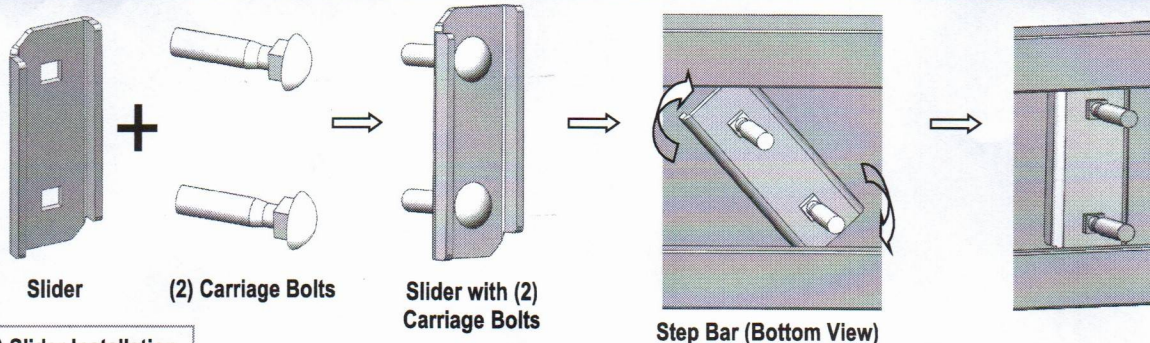

(Fig 9) Slider Installation

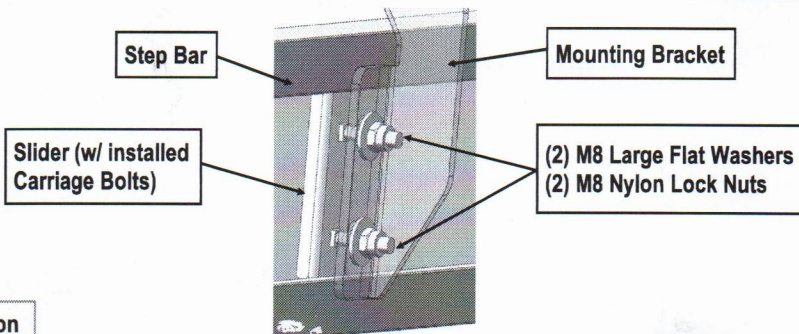

(Fig 10) Step Bar Installation

Customer Support: info@iboardauto.com