

MOMENTUM^{GT}

advanced FLOW engineering Cold Air Intake System

Instruction Manual P/N: 50-70042D / 50-70042R

Make: Chevrolet
Make: GMC

Model: Silverado 1500
Model: Sierra 1500

Year: 2019-2024
Year: 2019-2024

Engine: I4-2.7L (t)
Engine: I4-2.7L (t)



- Please read the entire instruction manual before proceeding.
- Ensure all components listed are present.
- For technical support please call 951-493-7185.
- Ensure you have all necessary tools before proceeding.
- Do not attempt to work on your vehicle when the engine is hot.
- Retain factory parts for future use.

Label	Qty.	Description	Part Number
A1	1	Air Filter (Pro 5R)	24-91147
A2	1	Air Filter (Pro DRY S)	21-91147
B	1	Tube	05-5070042B1
C	1	Housing	05-5070044B2
D	1	Coupling, Silicone Elbow	05-01758
E	1	Clamp, 056 (3-1/16" - 4")	03-50009
F	1	Clamp, 044 (2-5/16" - 3-1/4")	03-50019
G	1	Fitting, Vent Tube	05-01692
H	1	Clamp, T-bolt (8-5/16" - 8-5/8")	03-50267
J	1	Plug, Silicone	05-01429
K	2	Screw, Torx: M4x8mm	03-50491
M	2	Ties, Nylon Cable Push Mount	03-50492

Installation will require the following tools:

Panel clip remover, T15, T20 & T30 Torx drivers, 8mm nut driver, small flat-head screwdriver, 10mm & 11mm deep sockets and driver, 15mm wrench or adjustable wrench.

Warranty Information available at <https://afepower.com/contact#warranty>

Emissions Disclaimer: This product is not currently CARB exempt and is not available for purchase in California or for use on any vehicle registered with the California Department of Motor Vehicles.

IMPORTANT: The Air Filter Life System needs to be reset to 100% and then disabled. Follow your owner's manual procedure titled "*How to Reset the Engine Air Filter Life System*" then disable the system entirely. Failure to disable the system may prompt a persisting "Check Engine Air Filter System" message.

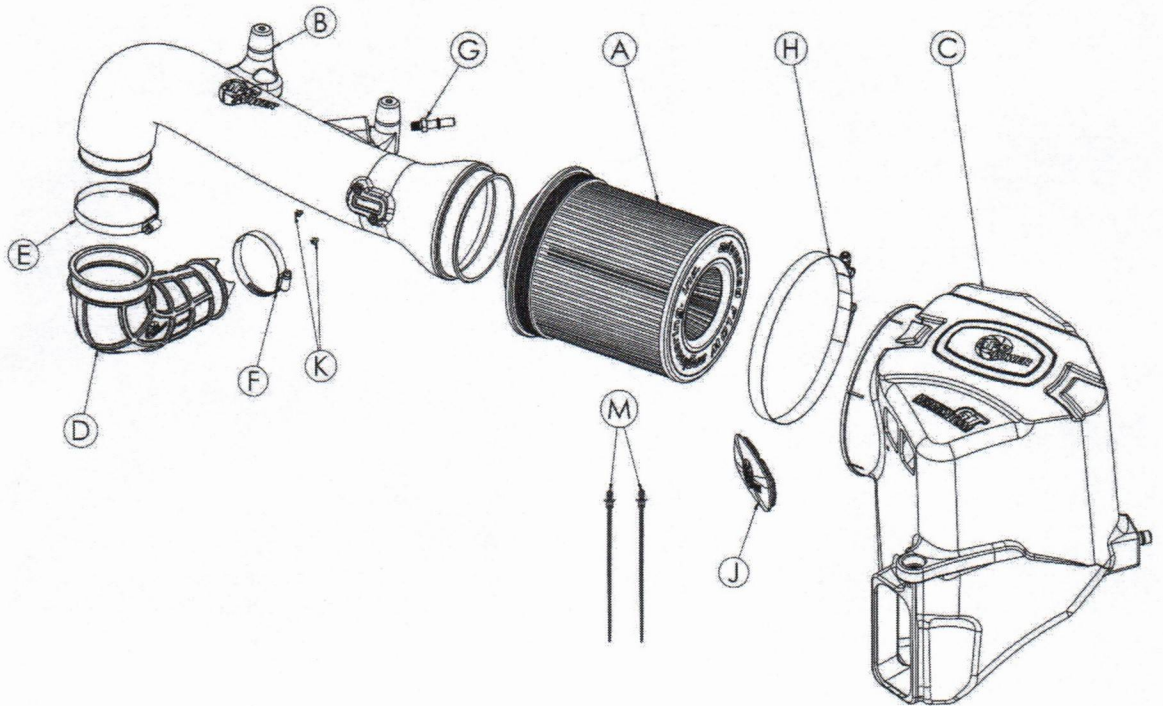

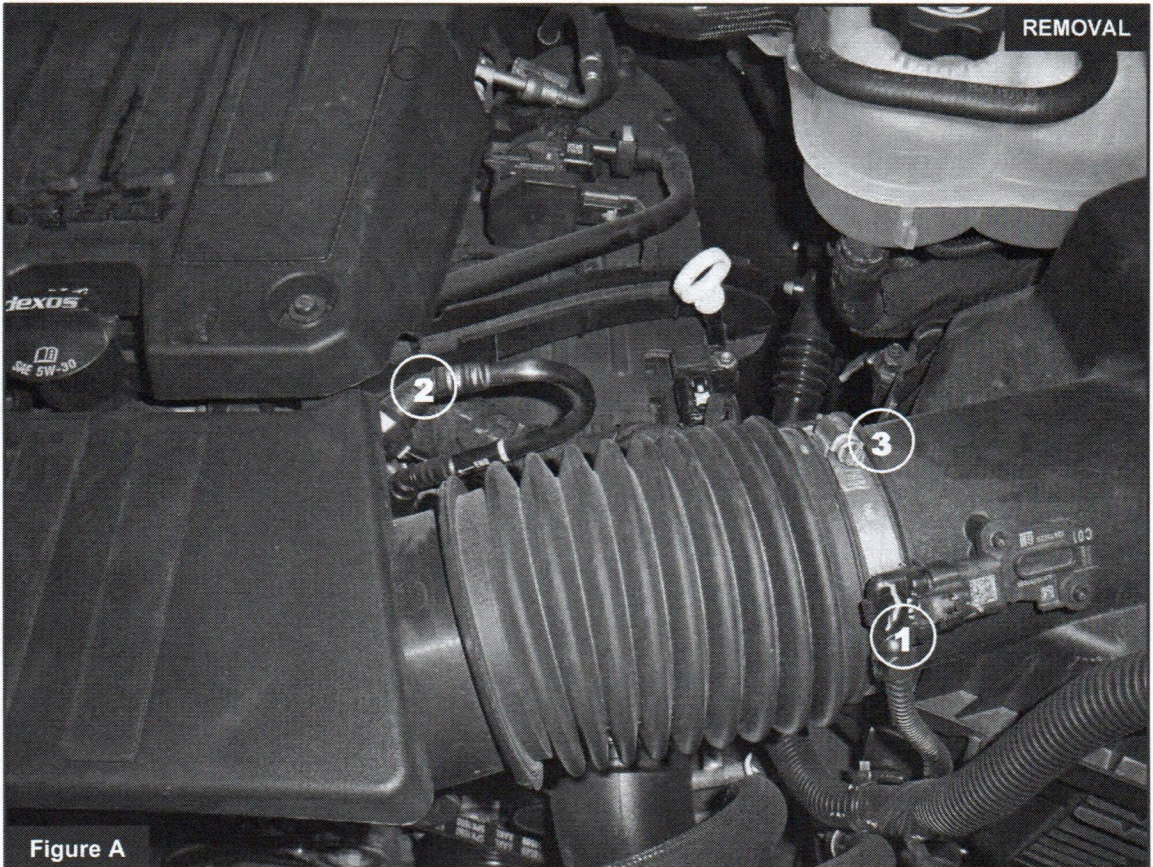

Figure A

Refer to Figure A for Steps 1-3

Step 1: Disconnect the MAF sensor ①.

Step 2: Disconnect the crankcase breather hose ② by pushing in the clip and pulling the hose out.

Step 3: Using an 8mm nut driver, loosen the hose clamps at the housing ③.

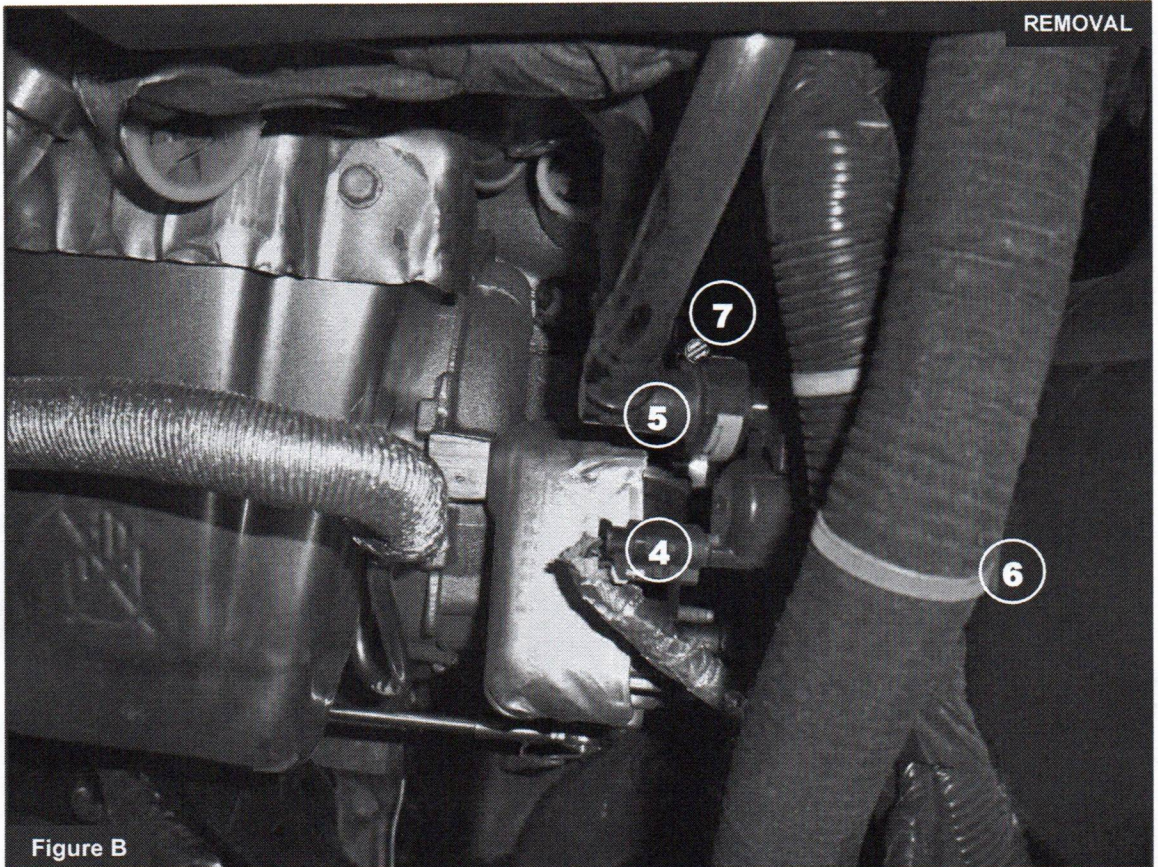

Figure B

Refer to Figure B for Steps 4-7

Step 4: Disconnect the electrical connector at the purge valve (4).

Step 5: Disconnect the purge line (5) from the purge valve.

Step 6: Disengage any wiring harnesses (6) attached to the intake tube.

Step 7: Using an 8mm nut driver, loosen the hose clamps at the turbo (7).

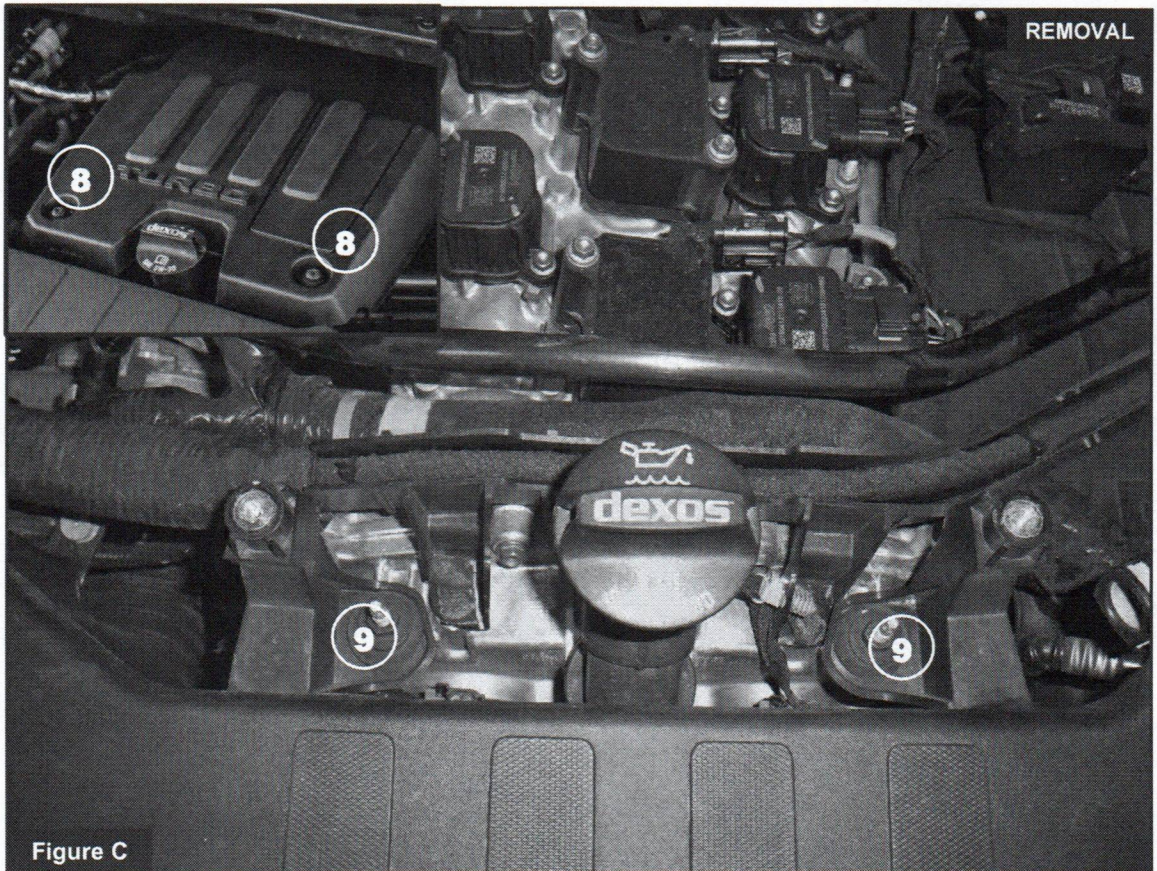

Refer to Figure C for Steps 8-10

Step 8: Using a T30 Torx driver or a 10mm socket and driver, remove the two screws (8) holding down the engine cover. Remove the engine cover and set the screws aside for later use.

Step 9: Using a 10mm deep socket and driver, remove the two nuts (9) holding down the intake tube and set them aside for later use.

Step 10: Remove the intake tube.

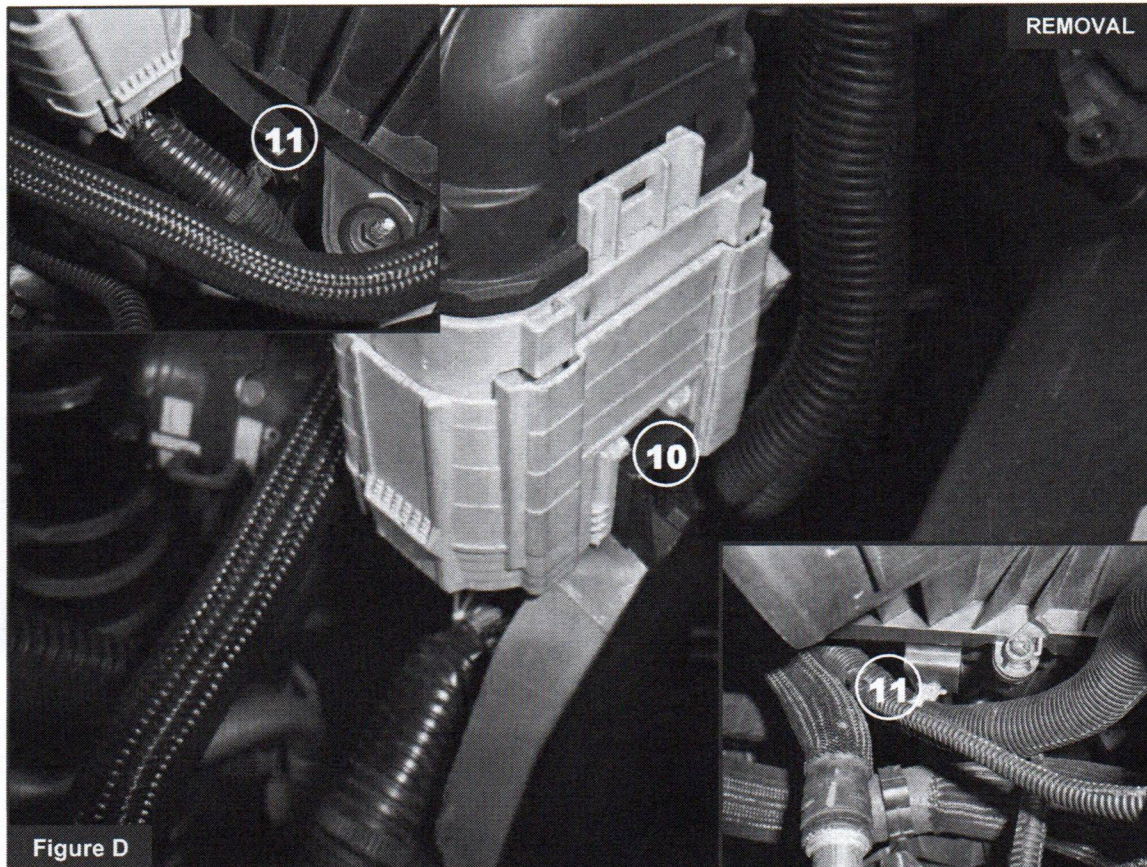

Figure D

Refer to Figure D for Step 11

Step 11: Using a small flat-head screwdriver, release the locking tab at the wiring harness connector (10) and unsnap the two harness ties (11) then move the harness out of the way.

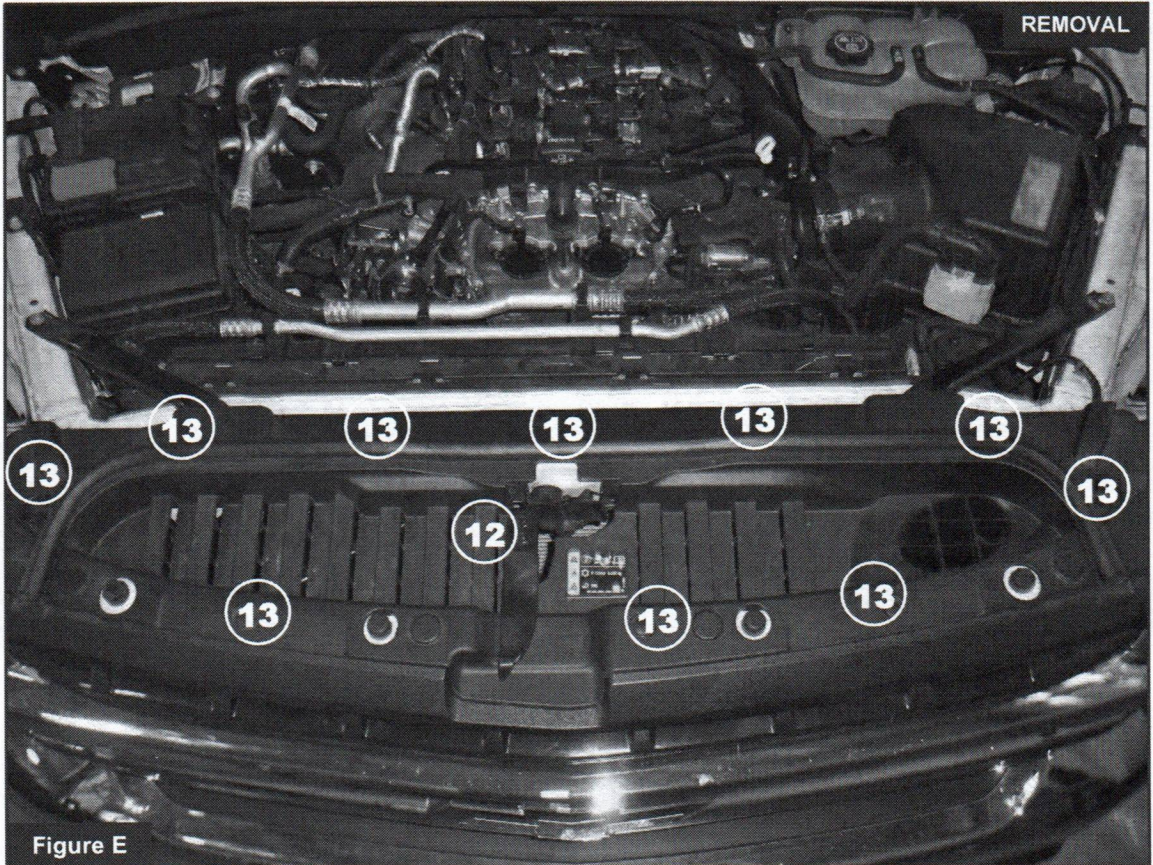

Figure E

Refer to Figure E for Steps 12-13

Step 12: Using a T15 Torx driver, remove the two screws (12) securing the hood latch lever and then slide it out to remove. Set the lever and screws aside.

Step 13: Using a panel clip remover, remove all ten panel clips (13) holding the sight shield. Remove the shield and set it aside with the clips.

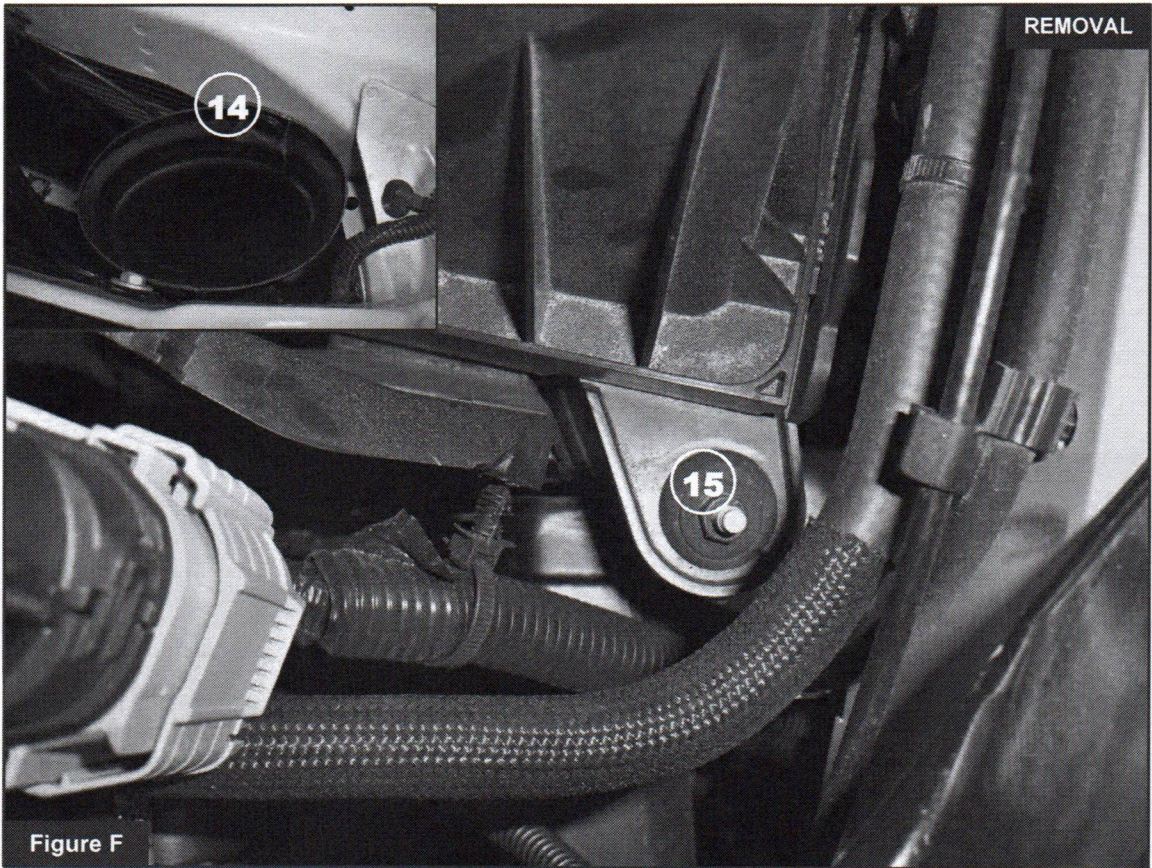

Figure F

Refer to Figure F for Steps 14-16

Step 14: Using the clip remover, remove the clip (14) holding the air scoop and set aside.

Step 15: Pull the air scoop out of the way from the factory housing.

Step 16: Using a 10mm deep socket and driver, remove the nut (15) that secures the housing to the vehicle and set it aside.

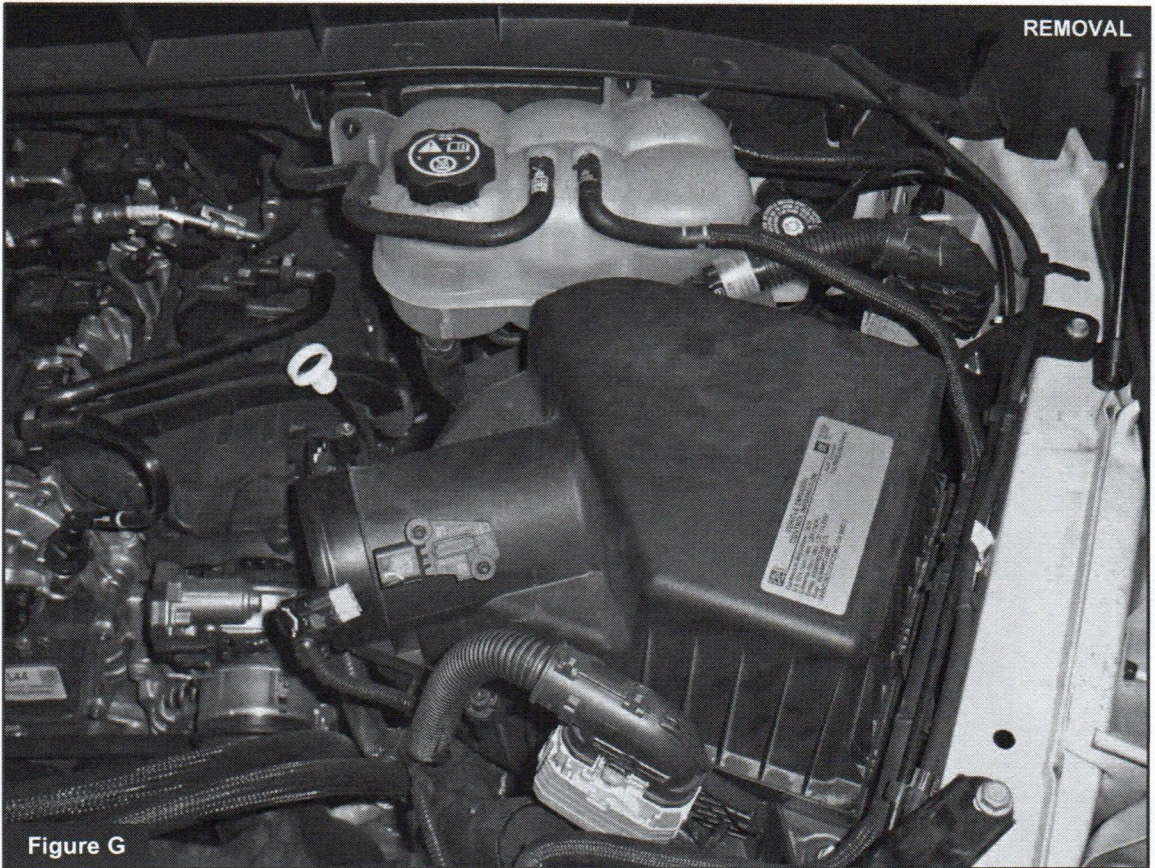

Figure G

Refer to Figure G for Step 17

Step 17: Remove the factory housing by pulling up out of the securing stud and towards the front of the vehicle. Two pins with grommets will have to come out of the holding bracket and a clear path is needed so that the air scoop is not in the way of the housing. Pull up on the housing to remove it from the vehicle.

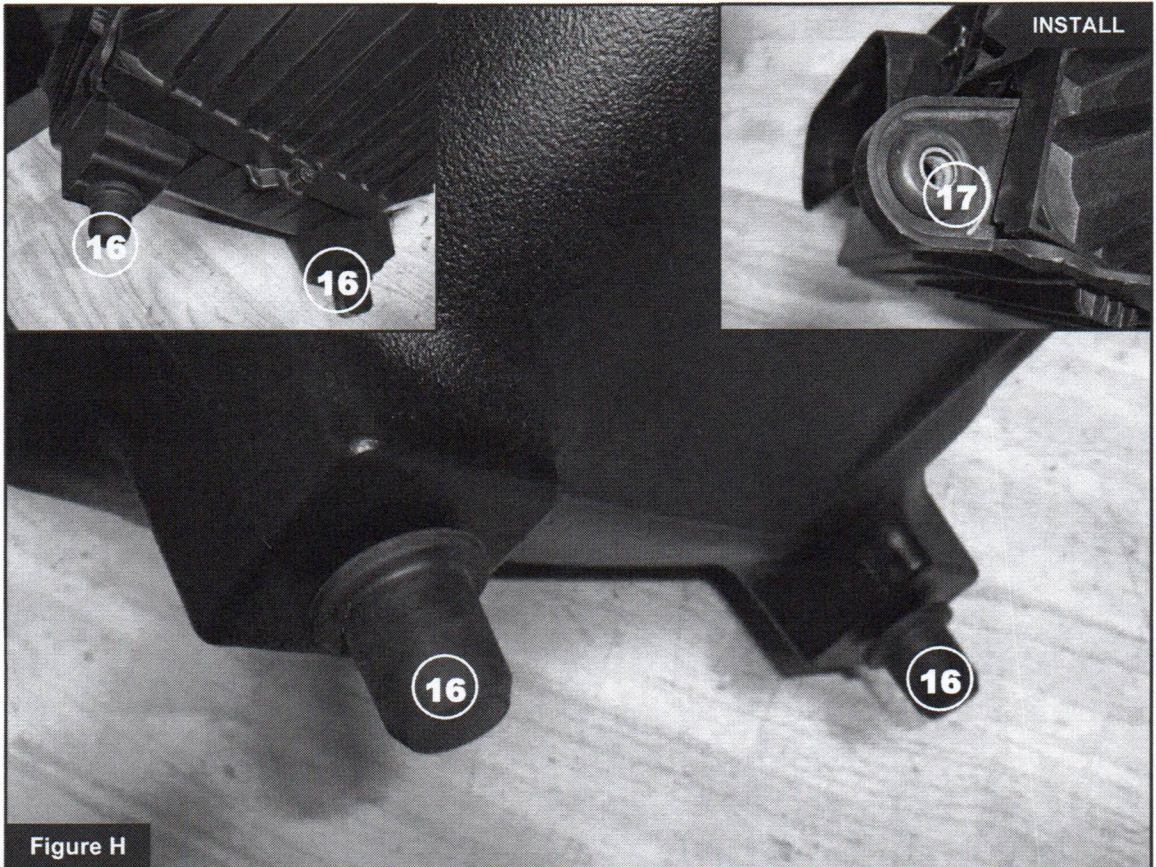

Figure H

Refer to Figure H for Steps 18-19

Step 18: Remove the two grommets ①⑥ from the factory housing pins and install them onto the aFe POWER housing.

Step 19: Remove the front metal insert and grommet ①⑦ from the factory housing and install them into the aFe POWER housing.

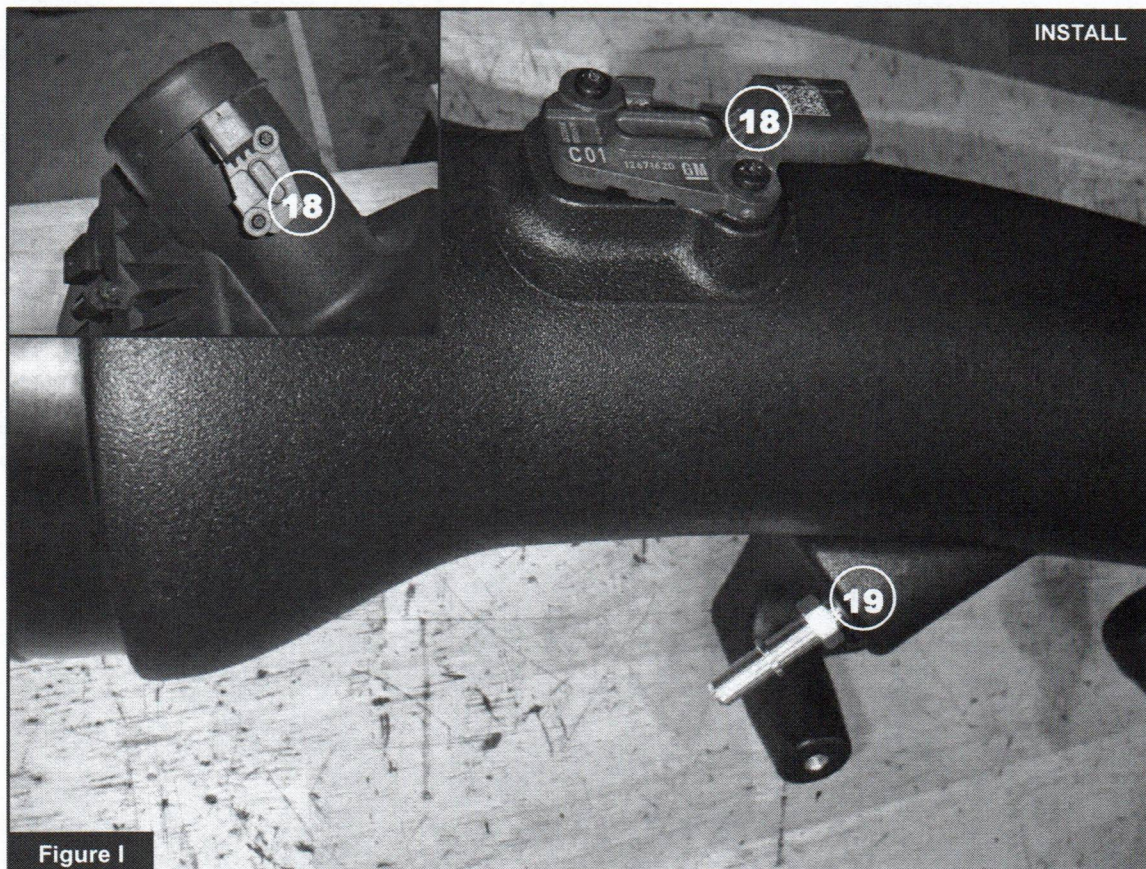
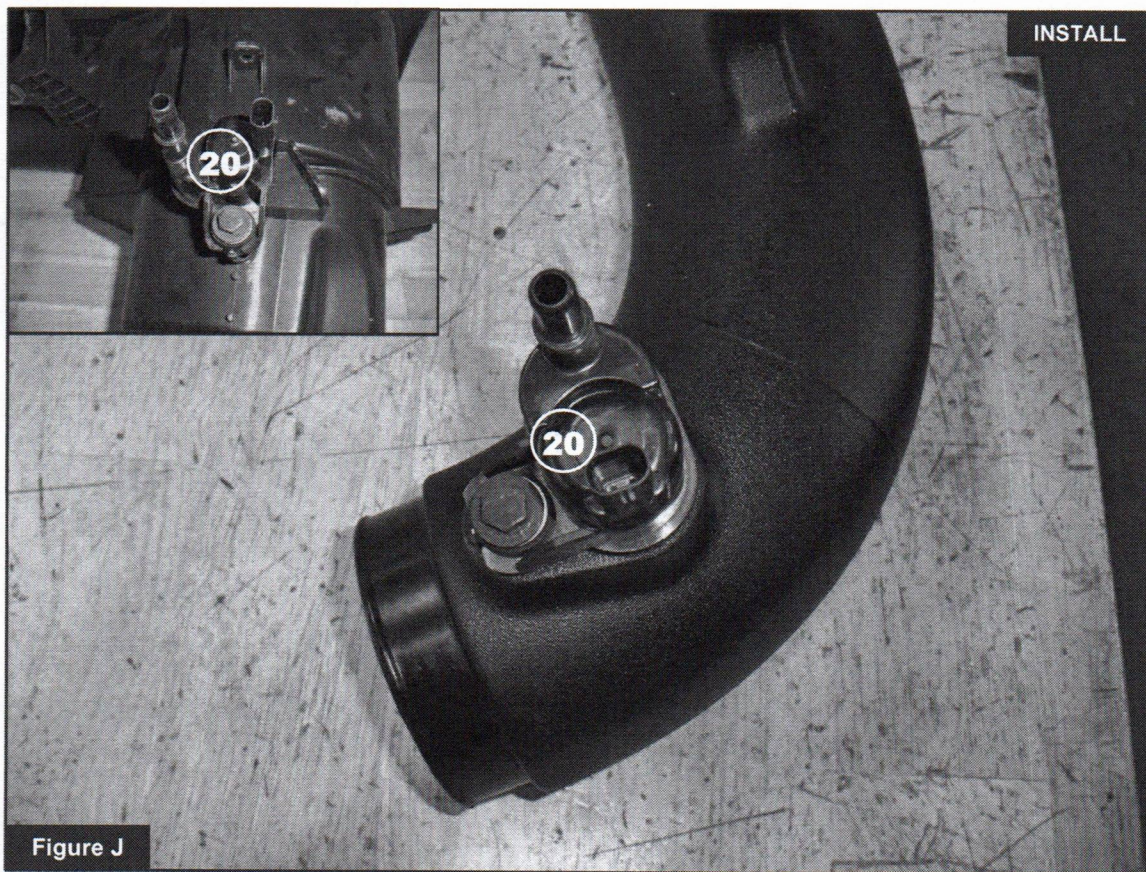

Figure I

Refer to Figure I for Steps 20-21

Step 20: Using a T20 Torx driver, remove the MAF sensor (18) from the factory housing and install it on the aFe POWER intake tube using the supplied M4 screws.

Step 21: Using a 15mm wrench or adjustable wrench, install the supplied aluminum vent fitting (19) into the aFe POWER intake tube.



Refer to Figure J for Step 22

Step 22: Using a 10mm socket and driver, carefully remove the purge valve (20) from the factory intake tube and install it into the aFe POWER intake tube.

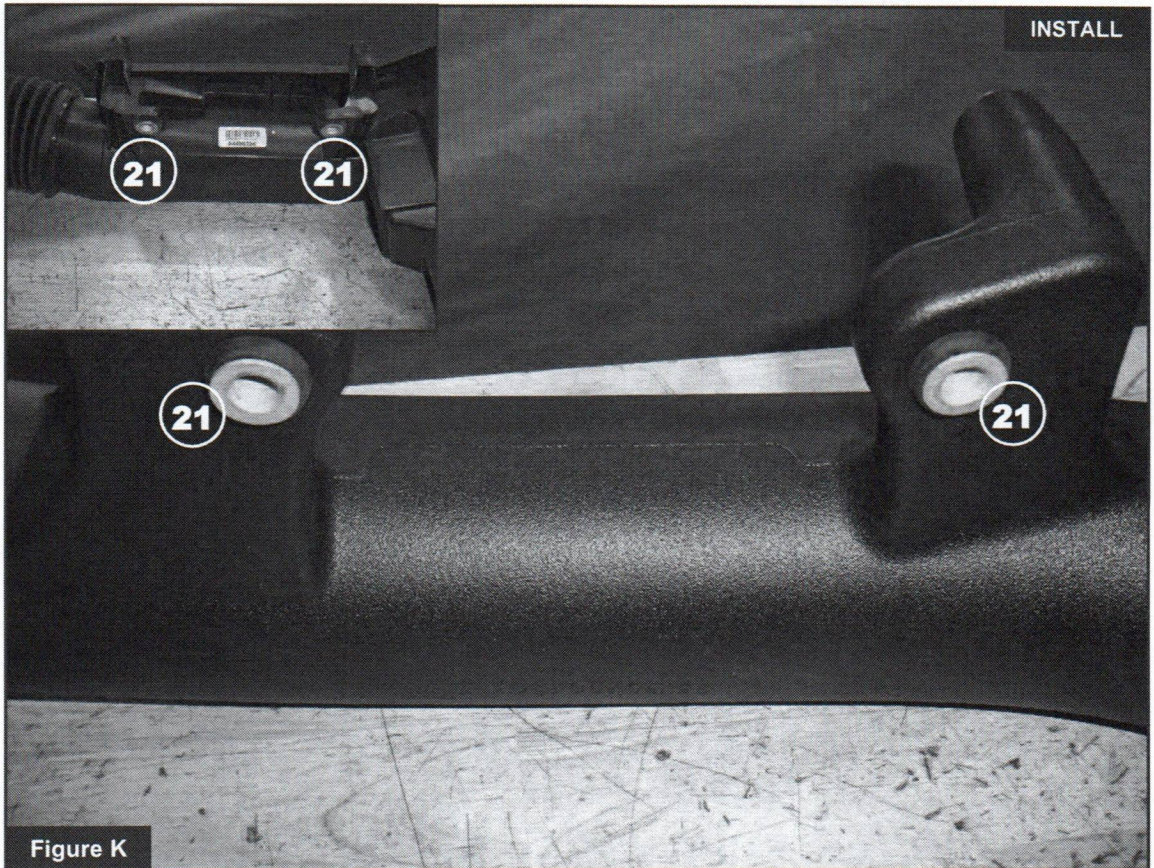

Figure K

Refer to Figure K for Step 23

Step 23: Remove the two grommets and metal inserts (21) from the factory intake tube and install them into the aFe POWER intake tube.

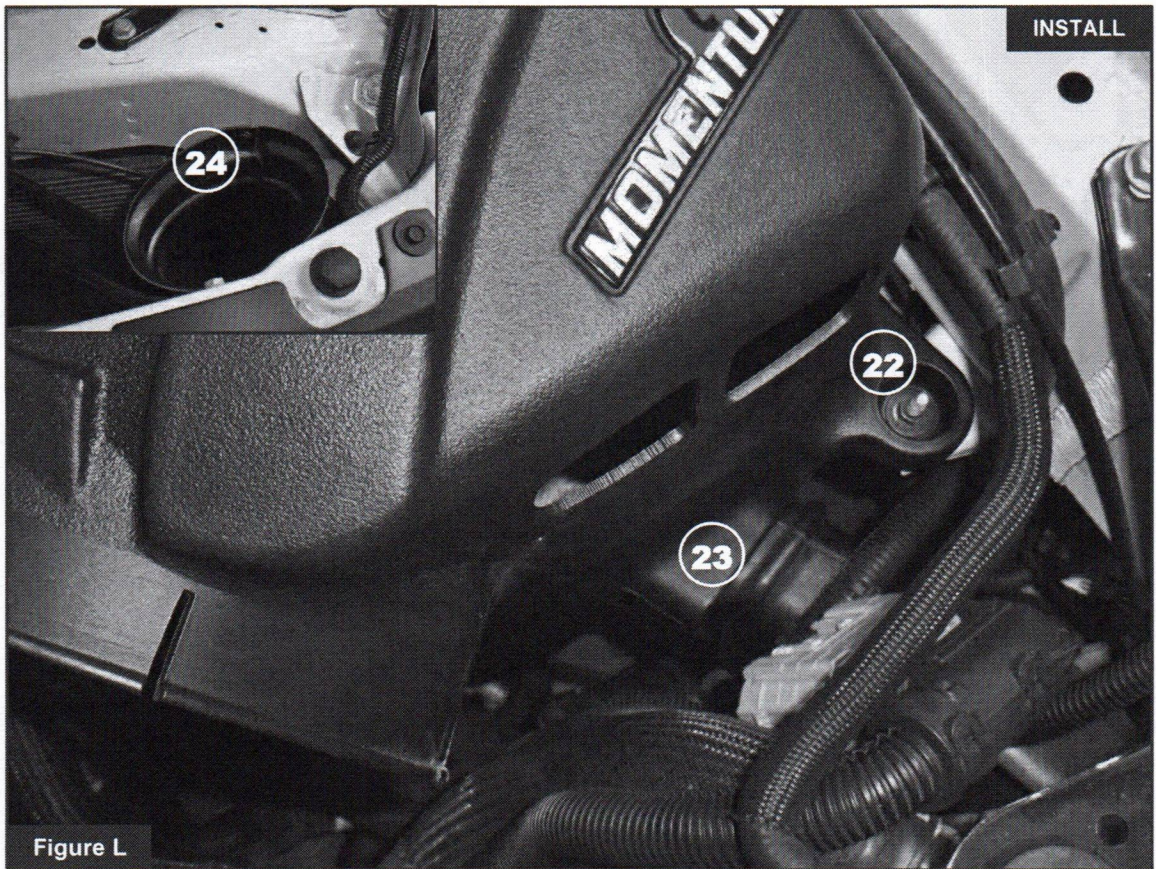

Figure L

Refer to Figure L for Steps 24-25

Step 24: Install the aFe POWER housing into the vehicle. Make sure the two pin grommets are secure inside the bracket and reinstall and tighten the nut (22) removed in Step 15.

Step 25: Slide the air scoop inside the front opening (23) of the aFe POWER housing. Align the air scoop and reinstall the clip (24) removed in Step 13.

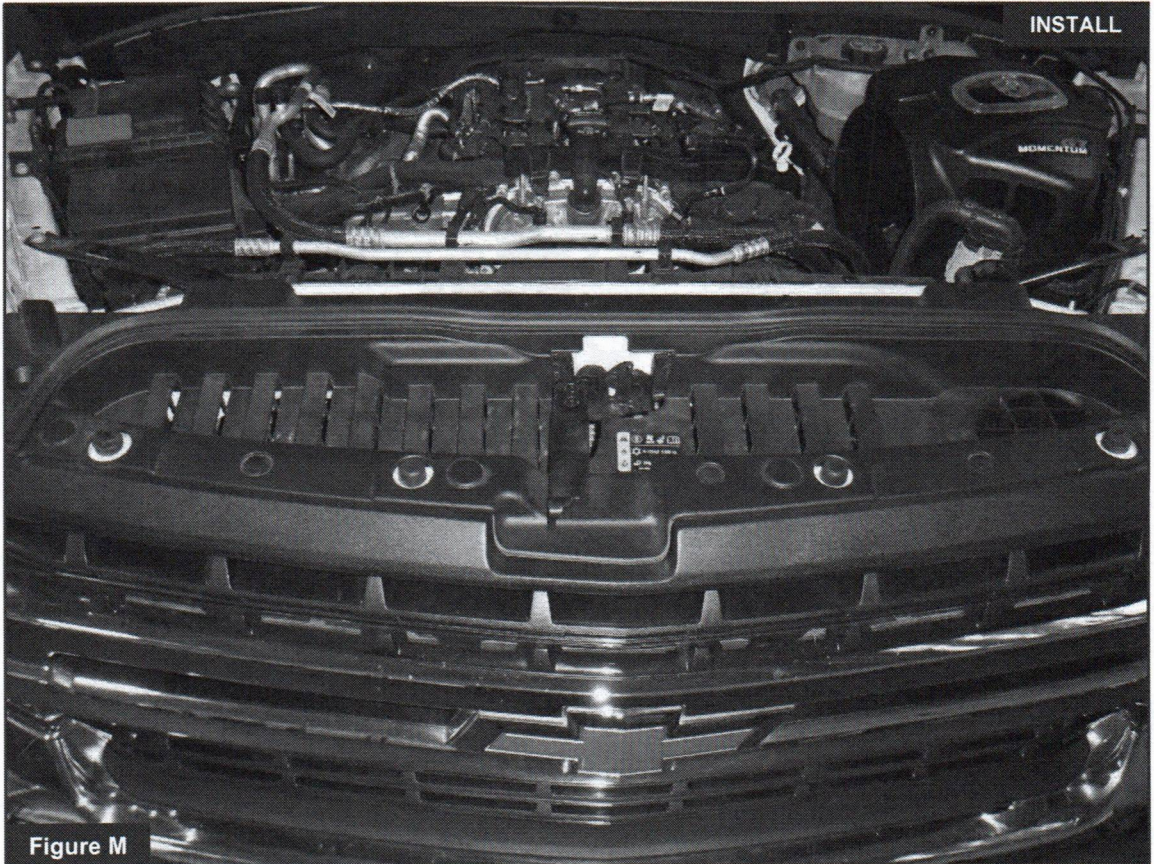

Figure M

Refer to Figure M for Steps 26-27

Step 26: Install the sight shield with all ten clips removed in Step 12.

Step 27: Install the hood latch with the two screws removed in Step 11 and tighten them.

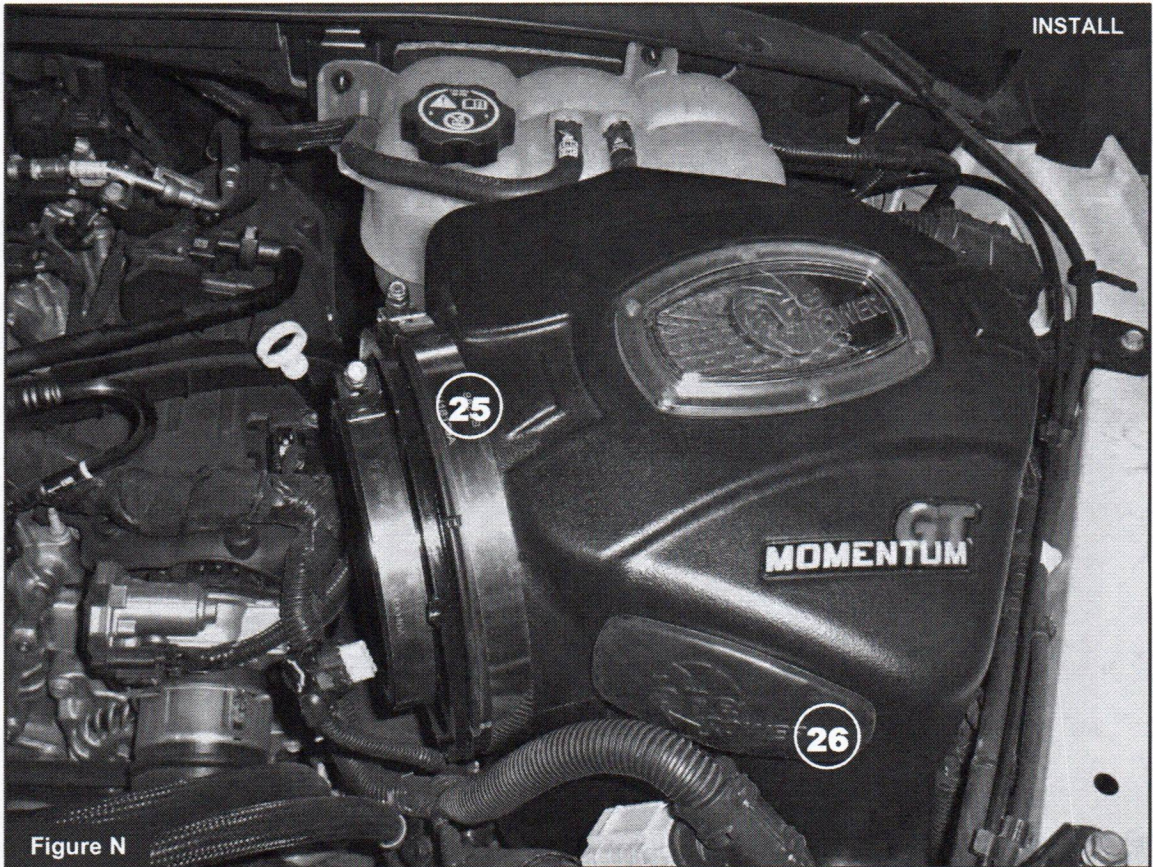

Figure N

Refer to Figure N for Steps 28-30

Step 28: Slide the large T-Bolt clamp (25) over the air filter opening on the housing.

Step 29: Slide the aFe POWER filter with clamp into the housing. Do not tighten the clamps.

Step 30: Use the provided plug (26) to close the additional air inlet if you want to completely seal the airbox.

Best performance gain is obtained by having more air flow (no plug).

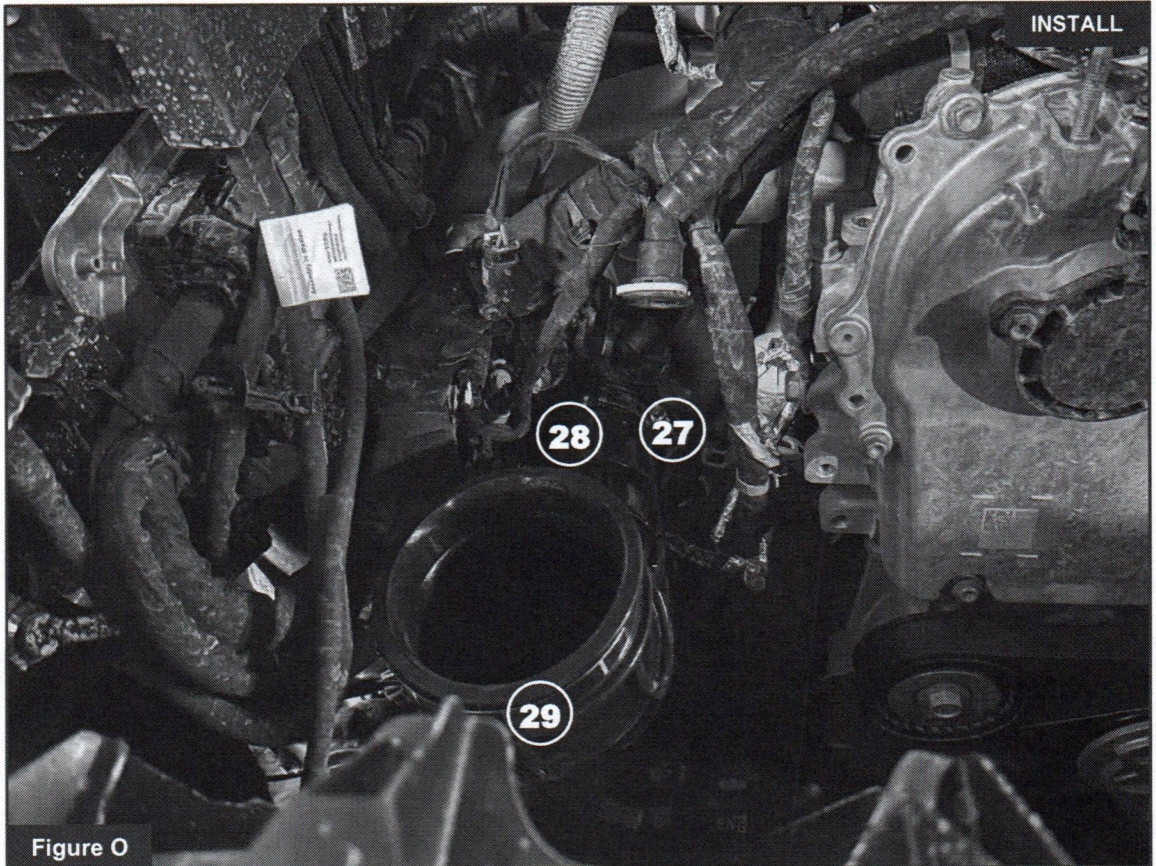

Figure O

Refer to Figure O for Steps 31-32

Step 31: Place the smaller clamp (27) and the silicone coupling (28) onto the turbo. Align the coupling so the large opening will point straight up and tighten the clamp using an 8mm deep socket and driver.

Step 32: Place the other clamp (29) over the large opening on the coupling.

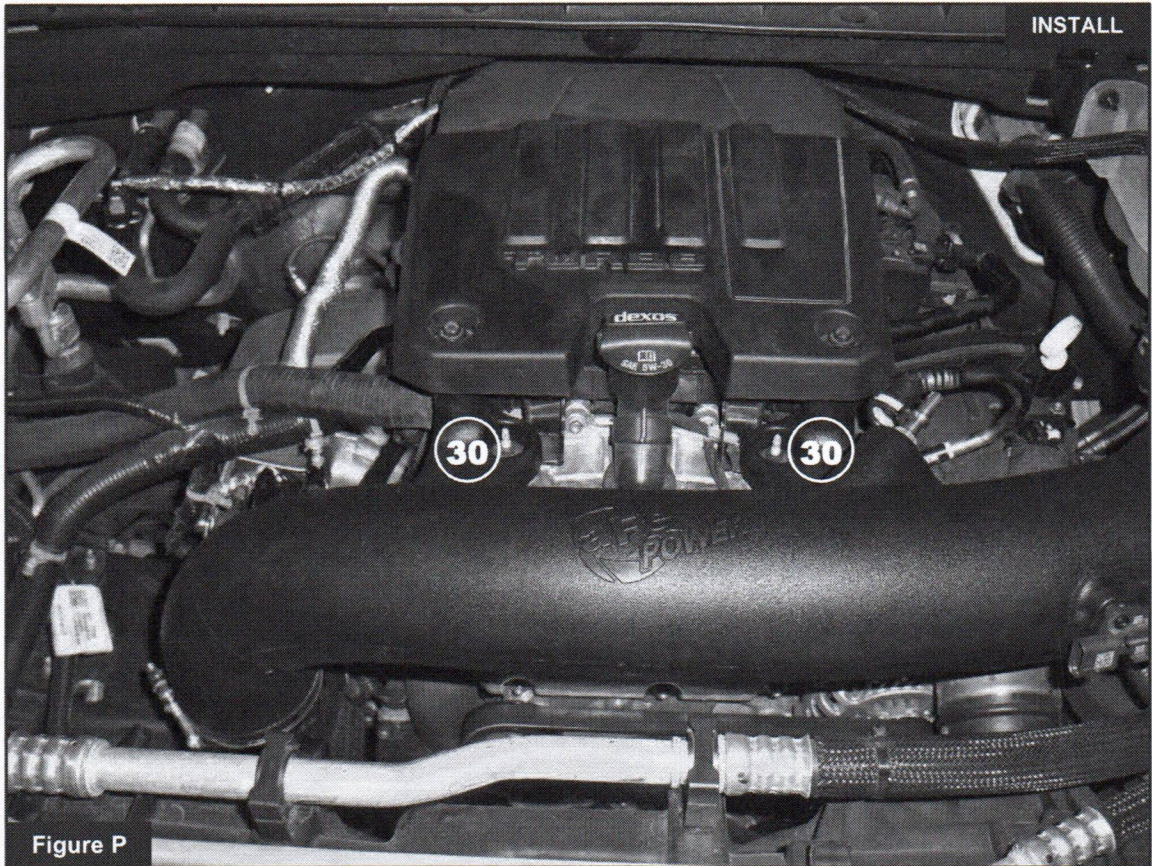

Figure P

Refer to Figure P for Steps 33-35

Step 33: Install the aFe POWER intake tube into the vehicle. Slide the tube into the filter while aligning the two grommets with metal inserts through the studs (30) on the timing cover, then slide the other end into the silicone coupling. Tighten all the clamps using a 11mm deep socket and driver.

Step 34: Reinstall the two nuts removed on Step 8 and tighten them using a 10mm deep socket and driver.

Step 35: Reinstall the engine cover with the two screws removed on step 8 using a T30 Torx driver or a 10mm socket and driver.

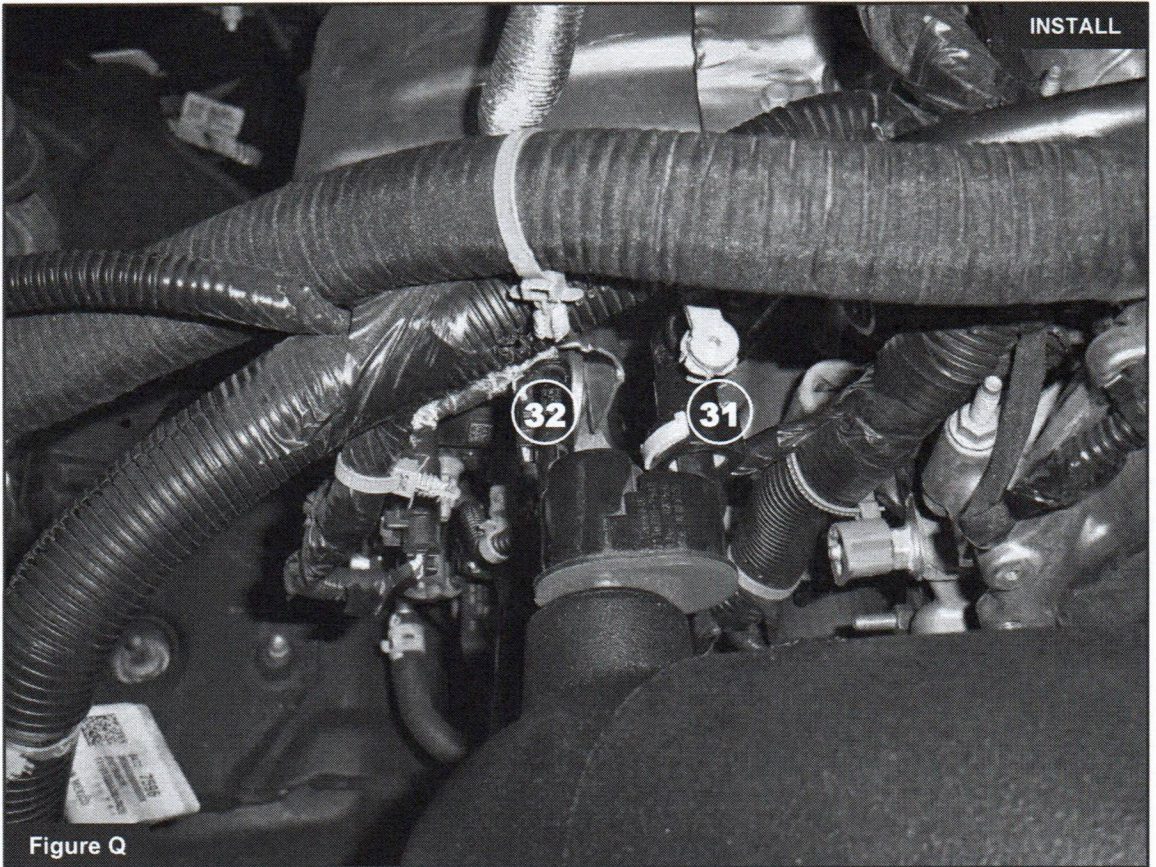

Figure Q

Refer to Figure Q for Step 36

Step 36: Reconnect the purge line (31) and the purge valve electrical connector (32) .

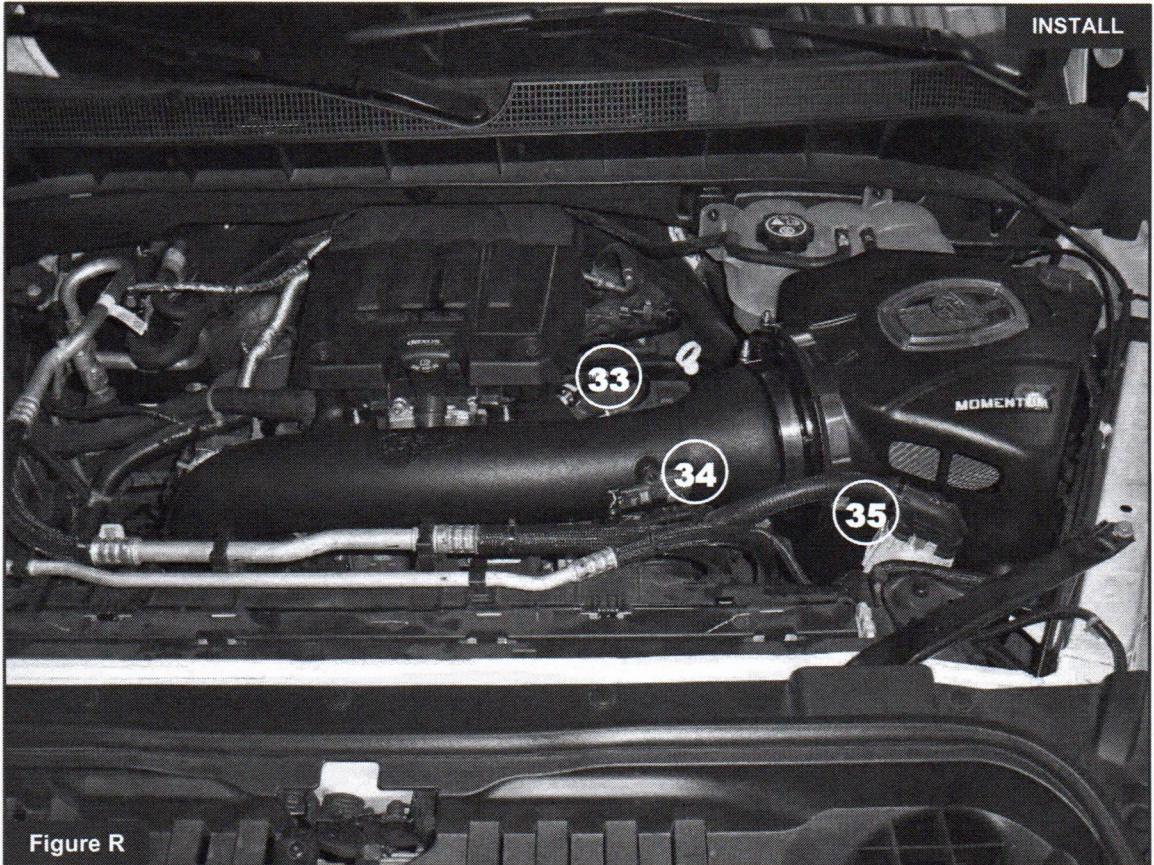

Figure R

Refer to Figure R for Steps 37-40

Step 37: Reconnect the crankcase breather hose (33).

Step 38: Reconnect the MAF sensor (34).

Step 39: Use the supplied captive tie (35) to secure the wiring harness to the aFe POWER housing and snap the tie in the upper provided hole. Snap the factory tie on the harness into the hole by the air scoop.

Step 40: Check all the components are tight and secure. Your installation is now complete. Thank you for choosing aFe POWER!



Page left blank intentionally



Page left blank intentionally

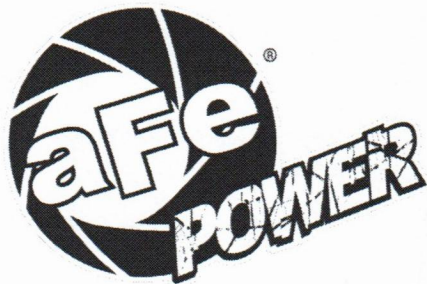

advanced FLOW engineering, inc.

Corona, CA 92879

<https://afepower.com/contact>