

BILLET ALUMINUM WHEEL SPACERS

INSTALLATION INSTRUCTIONS

FREE WARRANTY REGISTRATION >
 FREE INSTRUCTIONS >
 FREE SWAG >



WWW.COVOTEACCESSORIES.COM/WARRANTY

4 - THREAD ENGAGEMENT



Place wheel on to the Wheel Spacer hub until the wheel mounting angle sits flush on the spacer's outer flange. Install the fasteners and check minimum thread engagement. Once Minimum thread engagement is achieved, tighten fasteners as outlined in step 5.

Minimum thread engagement is 1.5 X diameter of thread.

See Chart to right for optimal thread engagement >>>

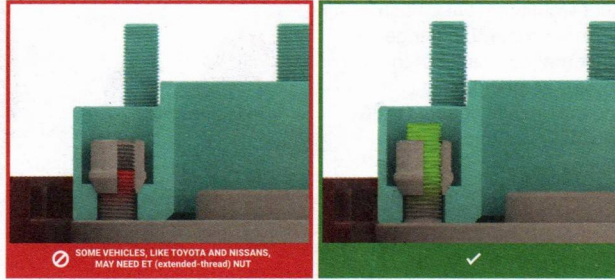

Minimum Thread Engagement		
Thread	1.50 x (mm)	1.50 x (IN)
7/16"	17mm	0.66"
1/2"	19mm	0.75"
12mm 1.25	18mm	0.71"
12mm 1.50	18mm	0.71"
14mm 1.50	21mm	0.83"
12mm 1.75	18mm	0.72"
14mm 2.00	21mm	0.83"
7/16"	21mm	0.84"

5 - INSTALL SPACER ON VEHICLE

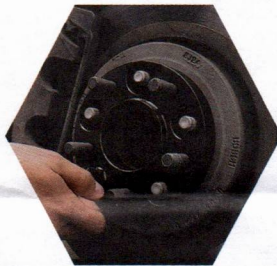

If proper seating can be achieved, mount the Wheel Spacer on the vehicle's hub until it sits flush with the rotor's flange.

First tighten all lugs to 30 Ft. Lbs. of torque using a star pattern tightening sequence. (see chart below)
 Once all lugs have been tightened to 30 Ft. Lbs. of torque.

Continue tightening lugs to the specified torque per your **owners manual**.

DO NOT USE AN IMPACT WRENCH!

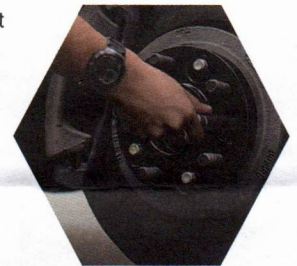
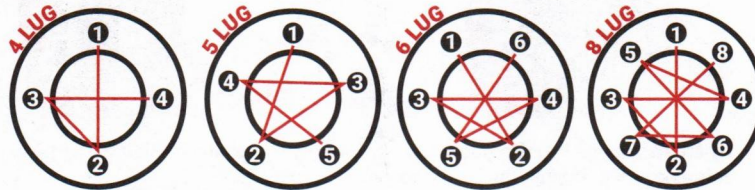

6 - INSTALL WHEEL & TIRE TO SPACER

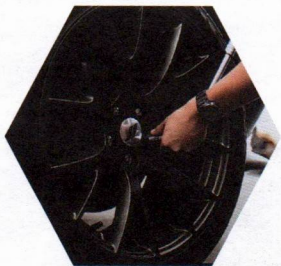

Check for proper tire clearance in the wheel well, making certain there is sufficient wheel and tire clearance for full steering (lock-to-lock).

If there is no interference, vehicle may be lowered. Once vehicle is on the ground under full load, recheck for adequate tire and wheel clearance and unobstructed lock-to-lock steering.

Re-torque all lug fasteners after 50-100 miles of driving, then again every 2-3,000 miles.

IMPORTANT SAFETY INFORMATION

NEVER modify a Wheel Spacer | **NEVER** use an impact wrench for Spacer installation | **DO NOT** stack multiple Spacers on a single wheel

To avoid excessive loads on a vehicle's suspension components, it is recommended that the vehicle manufacturer's original offset be maintained. Excessive negative offset can be dangerous and can cause suspension component failure. The Manufacturer assumes no responsibility for damages or repair costs incurred as a result of a change in offset.

Modified vehicles may not meet local or state requirements for use on public streets. Always research and adhere to federal, state and local laws regarding the use of wheel Spacers.

Carefully follow the installation instructions included on this package. Revolution Supply assumes no liability for injury, damage or repair costs resulting from improper installation or use.

BILLET ALUMINUM WHEEL SPACERS

INSTALLATION INSTRUCTIONS

FREE WARRANTY REGISTRATION >
FREE INSTRUCTIONS >
FREE SWAG >



WWW.COVOTEACCESSORIES.COM/WARRANTY

Following your vehicle owner's manual, properly raise the vehicle and support it using adequately load-rated jack stands. **Never** work on a raised vehicle that is supported with factory emergency, floor or bottle jack. Remove wheels and inspect rotors for any damage or cracks, If any damage is identified, **do not** continue with this installation

1 - PREPARE VEHICLE



After removal of tires and inspection of rotors, remove any visible rust from the mating flange on the vehicle's rotor. Inspect both the rotor and wheel mounting flanges for burns, rivet heads, or other obstruction that would prevent a flush seating of the vehicle rotor's mounting flange to both the inner and outer side of the spacer. Improperly seated spacers are hazardous and may cause spacer failure, resulting in the loss of a wheel while driving the vehicle. Please refer to installation sequence

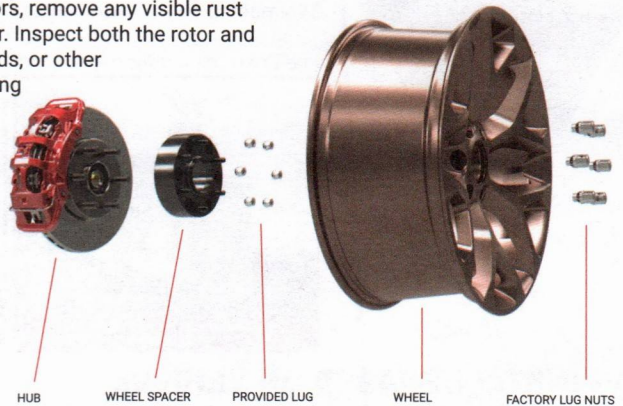

2 - CHECK HUB DIAMETER



The following are the proper conditions to be considered when installing Wheel Spacers. **DO NOT** proceed with the installation if these requirements are not met.



Figure 1

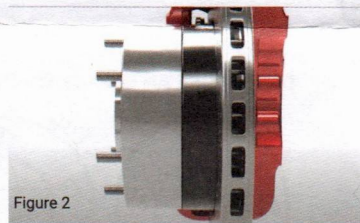

Figure 2

When placing the Wheel Spacer over the factory wheel studs (Figure 1), make sure sits completely flat against the HUB (Figure 2).

3 - CHECK STUDS LENGTH



Factory wheel studs must not protrude past the new wheel mounting surface of the Wheel Spacers.



If you find yourself in the situation that the studs protrude past the new mounting surface of the Wheel Spacers, this can prevent the wheel from sitting flush to the Spacer, if that is the case then only use wheels that have open pockets or rim pockets to ensure the factory studs fit comfortably inside them.

