

7929 Lincoln Ave. Riverside, CA 92504
 Phone: 951.689.ICON | Fax: 951.689.1016

PART #	DESCRIPTION
37705EP	99-UP FSD 4WD 0-3" REAR 2.5 VS PB CDEV PAIR

COMPONENTS INCLUDED	
(2) 134944PBE-AL 99-UP FSD 4WD 0-3" REAR 2.5 VS PB CDEV	(1) 255604-20 EXTENSION HARNESS COIL IIC CONTROLLER 20-FT (1) 255604-30 EXTENSION HARNESS COIL IIC CONTROLLER 30-FT
HARDWARE INCLUDED	
(1) 257161 HEIM SPACER COM10 X 14MM X 1.925 (1) 257162 HEIM SPACER COM10 X 14MM X 1.175	(2) 257164 HEIM SPACER COM10 X .500 X 1.500
TOOLS REQUIRED	
JACK JACK STANDS TORQUE WRENCH	18MM SOCKET / WRENCH 21MM SOCKET / WRENCH
TECH NOTES	
<p>1. YOUR ICON SHOCK ASSEMBLIES COME FACTORY CHARGED TO 150 PSI. RELEASING NITROGEN PRESSURE MAY LEAD TO SHOCK MALFUNCTION AND REDUCED RIDE QUALITY. FAILURE CAUSED BY LOW NITROGEN PRESSURE IS NOT COVERED UNDER ICON'S WARRANTY POLICY.</p> <p>2. THE LOWER HEIM SPACERS FOR 99-16 AND 17-UP ARE INCLUDED. USE THE 14MM SPACERS FOR 17-UP APPLICATIONS.</p>	



WARNING!
<p>** READ ALL INSTRUCTIONS THOROUGHLY FROM START TO FINISH BEFORE BEGINNING INSTALLATION! IF THESE INSTRUCTIONS ARE NOT PROPERLY FOLLOWED SEVERE FRAME, SUSPENSION AND TIRE DAMAGE MAY RESULT TO THE VEHICLE!</p> <p>** ICON VEHICLE DYNAMICS RECOMMENDS THAT YOU EXERCISE EXTREME CAUTION WHEN WORKING UNDER A VEHICLE THAT IS SUPPORTED WITH JACK STANDS.</p> <p>** ICON VEHICLE DYNAMICS RECOMMENDS ALL INSTALLTION TO BE PERFORMED BY A PROFESSIONAL SHOP/SERVICE TECHNICIAN. PRODUCT FAILURE CAUSED BY IMPROPER INSTALLATION WILL NOT BE COVERED UNDER ICON'S WARRANTY POLICY.</p>

INSTALLATION

- Using a properly rated jack, raise the rear of the vehicle and support the frame rails with jack stands. Ensure the jack stands are secure and set properly before lowering the jack. NEVER WORK UNDER AN UNSUPPORTED VEHICLE.
- Remove the factory shocks using 18mm and 21mm socket/wrench.
- Slide the wider spacer onto the stud on the upper shock mount. Slide the shock into the shock mount with the reservoir facing away from the axle. The driver side reservoir may need to be clocked (toward the spare tire) away from a wiring harness. Slide the narrow spacer onto the stud. [Torque to factory spec] [FIGURE 1 & 2]

FIG.1



FIG.2



4. Position the rod end in the lower mount and slide the bolt in. There are 2 sets of lower spacers provided. 99-16 FSDs have a 12mm bolt. 17-UP FSDs have 14mm bolt. Use the correct spacers for your vehicle. If using the 14mm bolt, offset the rod end toward the wheel. [Torque to factory spec] [FIGURE 3]

FIG.3



5. Refer to IIC install instructions for wire installation.

VERIFY ALL FASTENERS ARE PROPERLY TORQUED BEFORE DRIVING VEHICLE.

RETORQUE ALL NUTS, BOLTS AND LUGS AFTER 100 MILES AND PERIODICALLY THEREAFTER.

2.5 VS SERIES SHOCK & COILOVER TECHNICAL INFORMATION

MAINTENANCE

ICON shock absorbers are a high quality rebuildable race style shock absorber designed for optimal performance. With a unit of this caliber on your vehicle, routine maintenance is required to keep them looking and operating in like new condition. Residual oil and assembly lube may be present at all seal paths from the factory out of the box and is considered normal. Pooling of oil however is not acceptable at any time and one should contact the ICON dealer where purchased.

BELOW ARE GUIDELINES BASED ON HOW YOU USE YOUR VEHICLE BUT YOUR MILEAGE MAY VARY:

STREET USE:

- Send in for factory servicing every 40,000 miles or if a leak develops, ride quality decreases, or they begin to make excessive noise.
- Remove any buildup of road salt, mud, or debris from shocks and coil springs anytime accrued
- Clean with mild soap and water with each oil change or anytime you notice build up.
- Wax the cylinders yearly with automotive wax to prevent corrosion.
- Check nitrogen pressure yearly. (252004 charge needle assembly available at any ICON distributor)
- Check bearings for excessive wear yearly.
- DO NOT apply any type of lube to the upper and lower bearings.

STREET/DIRT:

- Send in for factory servicing every 15,000 miles or if a leak develops, ride quality decreases, or they begin to make excessive noise.
- Clean with mild soap and water with each oil change, offroad trip, or anytime you notice build up.
- Wax the cylinders yearly with automotive wax to prevent corrosion.
- Check nitrogen pressure each dirt outing. (252004 charge needle assembly available at any ICON distributor)
- Check bearings for excessive wear yearly.
- DO NOT apply any type of lube to the upper and lower bearings.

DIRT USE:

- Send in for factory servicing every 1,000 miles.
- Check nitrogen pressure each outing. (252004 charge needle assembly available at any ICON distributor)
- Remove any buildup of mud or debris from shocks and coil springs after every outing.

SELF-SERVICE:

- Contact ICON for service kits & tools at (951) 689-4266.

PRODUCT REGISTRATION

Please visit: <http://www.iconvehicledynamics.com/tech-support/registration/> to register your product.

ICON VEHICLE DYNAMICS SHOCK ABSORBER WARRANTY

This shock absorber has a 1 year warranty against any manufacturer's defects. If a shock fails within the initial year of ownership, the shock must be shipped to ICON Vehicle Dynamics for inspection and service. If a shock is inspected and it has been determined the shock failed due to neglect, damage caused by improper installation or any other reason besides "normal wear and tear", the owner of said shock is responsible for all service costs. This includes labor, parts, and shipping.

ICON Vehicle Dynamics warrants to the original retail purchaser who owns the vehicle on which the product was originally installed. ICON Vehicle Dynamics does not warrant the product for finish, alterations, modifications and/or installation contrary to ICON Vehicle Dynamics instructions. ICON Vehicle Dynamics products are not designed, nor are they intended to be installed on vehicles used in race applications, for racing purposes or for similar activities. (A "race" is defined as any contest between two or more vehicles, or a contest of one or more vehicles against the clock, whether or not such contest is for a prize). This warranty does not include coverage for police or taxi vehicles, race vehicles, or vehicles used for government or commercial purposes. Also excluded from this warranty are sales outside of the United States of America and Canada.

ICON Vehicle Dynamics' obligation under this warranty is limited to the repair or replacement, at ICON Vehicle Dynamics' discretion, of the defective product. Any and all costs of removal, installation or re-installation, freight charges and incidental or consequential damages are expressly excluded from this warranty. Items that are subject to wear are not considered defective when worn and are not covered.

ICON Vehicle Dynamics components must be installed as a complete kit as shown in our current application guide. Any substitutions or exemptions of required components will immediately void the warranty. Some finish damage may happen to parts during shipping and is not covered under warranty.

This warranty is expressly in lieu of all other warranties expressed or implied. This warranty shall not apply to any product that has been improperly installed, modified or customized subject to accident, negligence, abuse or misuse.

To send a shock in for warranty please visit our website <http://www.iconvehicledynamics.com/tech-support/shock-service/>

7929 Lincoln Ave. Riverside, CA 92504
 Phone: 951.689.ICON | Fax: 951.689.1016

PART #	DESCRIPTION
61721E	05-UP FSD 4-5.5" 2.5 VS RR CDEV BOLT IN COILOVER CONVERSION KIT

COMPONENTS INCLUDED	
(2) 164949E 05+ FSD 4-5.5" 2.5 VS RR CDEV BOLT IN COILOVER (1) 255604-06 EXTENSION HARNESS COIL IIC CONTROLLER 6-FT	(1) 255604-14 EXTENSION HARNESS COIL IIC CONTROLLER 14-FT (1) 61721H HARDWARE KIT (1) 611051 HARDWARE KIT
HARDWARE INCLUDED	
61721H HARDWARE KIT	
(2) 164017 05+ FSD C/O LOWER MOUNT (2) 160085 05+ FSD CO CONV 7.5" RESI BRACKET (2) 167011 05+ FSD 4" BUMP STOP SPACER (6) 605011 5/16-18 X 0.750 SCREW (12) 605016 5/16 FLAT WASHER (6) 605076 5/16-18 LOCK NUT (6) 605108 3/8-16 X 1.250 SCREW	(6) 605131 3/8 SPLIT LOCK WASHER (2) 605308 1/2-13 X 3.000 SCREW (2) 605322 1/2-13 LOCK NUT (4) 605330 1/2 FLAT WASHER (2) 605804 M8-1.25 X 120MM SCREW (2) 605806 M14-2.00 X 30MM SCREW
611051 HARDWARE KIT	
(4) 605931 1/2 X 2 1/16 - 3 ID #40 SS HOSE CLAMP	
TOOLS REQUIRED	
JACK JACK STANDS RECIPROCATING SAW SANDER DRILL 7/16" DRILL BIT TORQUE WRENCH	10MM SOCKET / WRENCH 22MM SOCKET / WRENCH 24MM SOCKET / WRENCH 5/16" SOCKET / WRENCH 7/16" SOCKET / WRENCH 9/16" SOCKET / WRENCH 3/4" SOCKET / WRENCH
TECH NOTES	
<p>1. YOUR ICON COILOVER ASSEMBLIES COME FACTORY CHARGED TO 150 PSI. RELEASING NITROGEN PRESSURE MAY LEAD TO SHOCK MALFUNCTION AND REDUCED RIDE QUALITY. FAILURE CAUSED BY LOW NITROGEN PRESSURE IS NOT COVERED UNDER ICON'S WARRANTY POLICY.</p> <p>2. YOUR ICON COILOVER ASSEMBLIES COME SHIPPED AT ICON'S RECOMMENDED RIDE HEIGHT. REDUCING DROOP TRAVEL WILL REDUCE RIDE QUALITY. DO NOT PRELOAD THE COIL BEYOND 1.5" OF EXPOSED THREADS BETWEEN THE BOTTOM OF THE TOP CAP AND THE TOP OF THE COIL ADJUSTER NUT. ADJUSTING PRELOAD BEYOND THIS SETTING WILL CAUSE THE COIL TO BIND AND DAMAGE WILL OCCUR TO COILOVER AND/OR VEHICLE.</p> <p>3. RETURNING TO A STOCK COIL SPRING REQUIRES FABRICATION. IF YOU PLAN TO RETURN VEHICLE TO STOCK AT A LATER DATE DO NOT DISCARD THE COIL CENTERING CUP THAT IS REMOVED IN STEP 7.</p> <p>4. TAKE CARE TO MAKE SURE THE WIRE HARNESS ABOVE THE WHEEL LINERS ARE NOT GETTING PINCHED OR CHAFED AFTER INSTALL.</p>	



WARNING!

**** READ ALL INSTRUCTIONS THOROUGHLY FROM START TO FINISH BEFORE BEGINNING INSTALLATION! IF THESE INSTRUCTIONS ARE NOT PROPERLY FOLLOWED SEVERE FRAME, SUSPENSION AND TIRE DAMAGE MAY RESULT TO THE VEHICLE!**

**** ICON VEHICLE DYNAMICS RECOMMENDS THAT YOU EXERCISE EXTREME CAUTION WHEN WORKING UNDER A VEHICLE THAT IS SUPPORTED WITH JACK STANDS.**

**** ICON VEHICLE DYNAMICS RECOMMENDS ALL INSTALLATION TO BE PERFORMED BY A PROFESSIONAL SHOP/SERVICE TECHNICIAN. PRODUCT FAILURE CAUSED BY IMPROPER INSTALLATION WILL NOT BE COVERED UNDER ICON'S WARRANTY POLICY.**

INSTALLATION

1. Using a properly rated jack, raise the front of the vehicle and support the frame rails with jack stands. Ensure the jack stands are secure and set properly before lowering the jack. NEVER WORK UNDER AN UNSUPPORTED VEHICLE. Remove the front wheels.



FIG.1

2. Remove driver and passenger front shocks with a 3/4" socket/wrench. [FIGURE 1 & 2]



FIG.2

3. Remove the track bar bolt at frame. [FIGURE 3]

FIG.3



4. Lower the front axle until the coils can be removed from vehicle. [FIGURE 4 & 5]

FIG.4



FIG.5



5. Remove the lower coil mount with a 22mm socket/wrench and the lines attached to it using 10mm socket/wrench. [FIGURE 6 & 7]

FIG.6



FIG.7



6. Remove the inner fender liner.

7. With a reciprocating saw and a 10" blade, use the coil bucket as a guide and cut out the centering cup from the upper coil mount on both driver and passenger side. [FIGURE 8]

FIG.8



FIG.9



8. Grind any material that keeps the upper coil bucket from being smooth and flat. [FIGURE 9]

9. Locate (164035) reservoir mount which is also the drill template. With a c-clamp or welding vise grips, clamp the reservoir mount so the 90 degree flange is parallel to the length of the vehicle as shown. [FIGURE 10]

FIG.10



10. Using a transfer punch, mark the locations of all 3 holes in the reservoir bracket.

11. Protecting all components in the engine compartment, using a 7/16" drill bit carefully drill the 3 holes that were marked with the reservoir bracket.

12. Spray paint the coil bucket to prevent corrosion from the removal of the cup or the drilled holes.

13. Locate (164017) lower shock mount and install using the supplied M14 hardware as shown with a 22mm socket/wrench. [Torque to 100 ft-lbs] [FIGURE 11]

FIG.11



14. Using the supplied 5/16" hardware, install the factory lines that were attached to the factory lower coil seat with a 1/2" socket/wrench. [Torque to 24 ft-lbs]

15. Remove the foam bump stop from the factory cup and remove the bolt holding the cup to the chassis with a 10mm socket/wrench. Locate the billet bumpstop spacer (167011) and bolt (605804). Install in between the factory cup and the frame on both the driver and passenger side. [Torque to 20 ft-lbs] [FIGURE 12 & 13]

FIG.12



FIG.13



16. Install the driver side coilover: The reservoir hose will point towards the front of the vehicle indicating the driver side. With the reservoir bracket sandwiched between the coil bucket and the coilover mount, use the supplied 3/8" hardware to fasten the coilover to the coil bucket. [Torque to 45 ft-lbs] Twist the hose and loop around to the reservoir mount as shown and attach reservoir to mount using the supplied hose clamps with a 5/16" socket/wrench. [FIGURE 14]

FIG.14



NOTE: failure to use the supplied reservoir bracket will cause the hose fitting to crash into the coil bucket.

17. With the supplied 1/2" hardware, mount the lower eyelet of the shock to the axle. Use a jack to help locate the assembly. [Torque to 80 ft-lbs] [FIGURE 15]

FIG.15



FIG.16



18. Reinstall the plastic wheel liner. [FIGURE 16]

19. Repeat steps on passenger side. Reattach the trackbar. [Torque to factory spec]

20. Install wheels/tires and remove vehicle from jack stands. [Torque lugs to factory spec]

21. Center the steering wheel by turning the tie rod adjuster. [FIGURE 17]

FIG.17



22. Refer to IIC install instructions for wire installation.

23. Have the vehicle professionally aligned.

VERIFY ALL FASTENERS ARE PROPERLY TORQUED BEFORE DRIVING VEHICLE.

RETORQUE ALL NUTS, BOLTS AND LUGS AFTER 100 MILES AND PERIODICALLY THEREAFTER.

2.5 VS SERIES SHOCK & COILOVER TECHNICAL INFORMATION

MAINTENANCE

ICON shock absorbers are a high quality rebuildable race style shock absorber designed for optimal performance. With a unit of this caliber on your vehicle, routine maintenance is required to keep them looking and operating in like new condition. Residual oil and assembly lube may be present at all seal paths from the factory out of the box and is considered normal. Pooling of oil however is not acceptable at any time and one should contact the ICON dealer where purchased.

BELOW ARE GUIDELINES BASED ON HOW YOU USE YOUR VEHICLE BUT YOUR MILEAGE MAY VARY:

STREET USE:

- Send in for factory servicing every 40,000 miles or if a leak develops, ride quality decreases, or they begin to make excessive noise.
- Remove any buildup of road salt, mud, or debris from shocks and coil springs anytime accrued
- Clean with mild soap and water with each oil change or anytime you notice build up.
- Wax the cylinders yearly with automotive wax to prevent corrosion.
- Check nitrogen pressure yearly. (252004 charge needle assembly available at any ICON distributor)
- Check bearings for excessive wear yearly.
- DO NOT apply any type of lube to the upper and lower bearings.

STREET/DIRT:

- Send in for factory servicing every 15,000 miles or if a leak develops, ride quality decreases, or they begin to make excessive noise.
- Clean with mild soap and water with each oil change, offroad trip, or anytime you notice build up.
- Wax the cylinders yearly with automotive wax to prevent corrosion.
- Check nitrogen pressure each dirt outing. (252004 charge needle assembly available at any ICON distributor)
- Check bearings for excessive wear yearly.
- DO NOT apply any type of lube to the upper and lower bearings.

DIRT USE:

- Send in for factory servicing every 1,000 miles.
- Check nitrogen pressure each outing. (252004 charge needle assembly available at any ICON distributor)
- Remove any buildup of mud or debris from shocks and coil springs after every outing.

SELF-SERVICE:

- Contact ICON for service kits & tools at (951) 689-4266.

PRODUCT REGISTRATION

Please visit: <http://www.iconvehicledynamics.com/tech-support/registration/> to register your product.

ICON VEHICLE DYNAMICS SHOCK ABSORBER WARRANTY

This shock absorber has a 1 year warranty against any manufacturer's defects. If a shock fails within the initial year of ownership, the shock must be shipped to ICON Vehicle Dynamics for inspection and service. If a shock is inspected and it has been determined the shock failed due to neglect, damage caused by improper installation or any other reason besides "normal wear and tear", the owner of said shock is responsible for all service costs. This includes labor, parts, and shipping.

ICON Vehicle Dynamics warrants to the original retail purchaser who owns the vehicle on which the product was originally installed. ICON Vehicle Dynamics does not warrant the product for finish, alterations, modifications and/or installation contrary to ICON Vehicle Dynamics instructions. ICON Vehicle Dynamics products are not designed, nor are they intended to be installed on vehicles used in race applications, for racing purposes or for similar activities. (A "race" is defined as any contest between two or more vehicles, or a contest of one or more vehicles against the clock, whether or not such contest is for a prize). This warranty does not include coverage for police or taxi vehicles, race vehicles, or vehicles used for government or commercial purposes. Also excluded from this warranty are sales outside of the United States of America and Canada.

ICON Vehicle Dynamics' obligation under this warranty is limited to the repair or replacement, at ICON Vehicle Dynamics' discretion, of the defective product. Any and all costs of removal, installation or re-installation, freight charges and incidental or consequential damages are expressly excluded from this warranty. Items that are subject to wear are not considered defective when worn and are not covered.

ICON Vehicle Dynamics components must be installed as a complete kit as shown in our current application guide. Any substitutions or exemptions of required components will immediately void the warranty. Some finish damage may happen to parts during shipping and is not covered under warranty.

This warranty is expressly in lieu of all other warranties expressed or implied. This warranty shall not apply to any product that has been improperly installed, modified or customized subject to accident, negligence, abuse or misuse.

To send a shock in for warranty please visit our website <http://www.iconvehicledynamics.com/tech-support/shock-service/>



ICON VEHICLE DYNAMICS®
PERFORMANCE SUSPENSION SYSTEMS AND SHOCK ABSORBERS

7929 Lincoln Ave. Riverside, CA 92504 Phone: 951.689.ICON Fax: 951.689.1016
www.iconvehicledynamics.com



FOLLOW US ON FACEBOOK!



7929 Lincoln Ave. Riverside, CA 92504
 Phone: 951.689.ICON Fax: 951.689.1016

PART #	DESCRIPTION
64038	2017-UP FSD ADJUSTABLE TRACK BAR KIT

COMPONENTS INCLUDED	
(1) 164037 2017-UP FSD ADJUSTABLE TRACK BAR (2) 167021 HEIM SPACER JM16 X .812 X 1.750 (1) 167027 LEFT/RIGHT ADJUSTER ROUND (1) 168001 05-UP TRACK BAR BALL JOINT W/NUT	(1) 295513 JM16-1T, 1-14 LH ROD END F1 FIT (2) 605145 3/8-16 X 1.000 12PT SCREW (1) 605951 SPIRAL RETAINING RING
HARDWARE INCLUDED	
N/A	
TOOLS REQUIRED	
TAPE MEASURE BALL JOINT SEPARATOR HAMMER 1/4" SPANNER WRENCH TORQUE WRENCH	3/8" 12PT SOCKET / WRENCH 13MM SOCKET / WRENCH 27MM SOCKET / WRENCH 30MM SOCKET / WRENCH (2)
TECH NOTES	
1. DO NOT EXCEED 3.375" OF ADJUSTMENT FROM THE CENTER OF THE ROD END TO THE EDGE OF THE TRACK BAR PINCH HOUSING. FAILURE CAUSED BY EXCESSIVE ADJUSTMENT WILL NOT BE COVERED UNDER ICON'S WARRANTY POLICY.	



WARNING!
** READ ALL INSTRUCTIONS THOROUGHLY FROM START TO FINISH BEFORE BEGINNING INSTALLATION! IF THESE INSTRUCTIONS ARE NOT PROPERLY FOLLOWED SEVERE FRAME, SUSPENSION AND TIRE DAMAGE MAY RESULT TO THE VEHICLE!
** ICON VEHICLE DYNAMICS RECOMMENDS THAT YOU EXERCISE EXTREME CAUTION WHEN WORKING UNDER A VEHICLE THAT IS SUPPORTED WITH JACK STANDS.
** ICON VEHICLE DYNAMICS RECOMMENDS ALL INSTALLTION TO BE PERFORMED BY A PROFESSIONAL SHOP/SERVICE TECHNICIAN. PRODUCT FAILURE CAUSED BY IMPROPER INSTALLATION WILL NOT BE COVERED UNDER ICON'S WARRANTY POLICY.

INSTALLATION

1. Remove the stock track bar from the frame bracket using (2) 30mm sockets/wrenches. The vehicle may shift slightly.
2. Remove the track bar from the ball joint taper on the axle. Using a 27mm, remove the nut and separate the ball joint using a ball joint separator and hammer.
3. Connect the ICON track bar to the axle. Use a 13mm to keep the tapered stud from spinning while tightening the nut with a 27mm socket/wrench. [Torque to factory spec] [FIGURE 1]

FIG.1



4. Loosen the pinch bolts using a 3/8" 12pt socket/wrench.
5. Adjust the collar of the track bar while keeping the threaded bushing housing from spinning. Adjust as needed to line up in the frame bracket.

6. Install the factory upper track bar bolt using (2) 30mm sockets/wrenches. [Torque to 406 ft-lbs] [FIGURE 2]

FIG.2



NOTE: This track bar is adjustable from 36.75" - 37.75". The stock track bar measures 36.625" from eye to eye.

7. Adjust the collar to center the axle under the frame. Do not exceed the maximum adjustment range as outlined in the tech notes.

8. Tighten the pinch bolts using an alternating pattern and a 3/8" 12pt socket/wrench. [Torque to 35 ft-lbs]

9. Use the drag link adjustment to center the steering wheel before driving.

10. Have the vehicle professionally aligned.

VERIFY ALL FASTENERS ARE PROPERLY TORQUED BEFORE DRIVING VEHICLE.

RETORQUE ALL NUTS, BOLTS AND LUGS AFTER 100 MILES AND PERIODICALLY THEREAFTER.

ICON VEHICLE DYNAMICS LIMITED LIFETIME WARRANTY

ICON Vehicle Dynamics warrants to the original retail purchaser who owns the vehicle on which the product was originally installed. ICON Vehicle Dynamics does not warrant the product for finish, alterations, modifications and/or installation contrary to ICON Vehicle Dynamics instructions. ICON Vehicle Dynamics products are not designed, nor are they intended to be installed on vehicles used in race applications, for racing purposes or for similar activities. (A "race" is defined as any contest between two or more vehicles, or a contest of one or more vehicles against the clock, whether or not such contest is for a prize). This warranty does not include coverage for police or taxi vehicles, race vehicles, or vehicles used for government or commercial purposes. Also excluded from this warranty are sales outside of the United States of America and Canada.

ICON Vehicle Dynamics' obligation under this warranty is limited to the repair or replacement, at ICON Vehicle Dynamics' discretion, of the defective product. Any and all costs of removal, installation or re-installation, freight charges and incidental or consequential damages are expressly excluded from this warranty. Items that are subject to wear are not considered defective when worn and are not covered.

ICON Vehicle Dynamics components must be installed as a complete kit as shown in our current application guide. Any substitutions or exemptions of required components will immediately void the warranty. Some finish damage may happen to parts during shipping and is not covered under warranty.

This warranty is expressly in lieu of all other warranties expressed or implied. This warranty shall not apply to any product that has been improperly installed, modified or customized subject to accident, negligence, abuse or misuse.

ICON VEHICLE DYNAMICS

PERFORMANCE SUSPENSION SYSTEMS AND SHOCK ABSORBERS

7929 Lincoln Ave. Riverside, CA 92504 Phone: 951.689.ICON Fax: 951.689.1016
www.iconvehicledynamics.com



FOLLOW US ON FACEBOOK!



7929 Lincoln Ave. Riverside, CA 92504
Phone: 951.689.ICON | Fax: 951.689.1016

PART #	DESCRIPTION
64039	08-UP FSD TRACK BAR BUMP STEER BRACKET KIT

COMPONENTS INCLUDED	
(1) 164045 08-UP FSD TRACK BAR BUMP STEER BRACKET (2) 167032 08-UP FSD TRACK BAR BUMP STEER CAM	(2) 167031 05+ FSD 1" BUMP STOP SPACER
HARDWARE INCLUDED	
(2) 605802 M8-1.25 X 40MM HEX HEAD BOLT	
TOOLS REQUIRED	
JACK JACK STANDS TORQUE WRENCH RATCHET BLUE THREAD LOCKER	10MM SOCKET/WRENCH 13MM SOCKET/WRENCH 18MM SOCKET/WRENCH 21MM SOCKET/WRENCH 30MM SOCKET/WRENCH
TECH NOTES	
<p>1. BUMP STEER CORRECTION IS INTENDED FOR 2.5" OR 4.5" LIFTS WITH THE USE OF THE FACTORY TRACK BAR OR ICON TRACK BAR SET TO THE FACTORY LENGTH.</p> <p>2. DEPENDING ON SUSPENSION SYSTEM THAT YOU PURCHASED, YOU MAY END UP WITH MORE THAN ONE SET OF FRONT BUMP STOP SPACERS. INSTALL THE TALLEST OF THE SUPPLIED FRONT BUMP STOP SPACERS WITH THIS BRACKET.</p>	

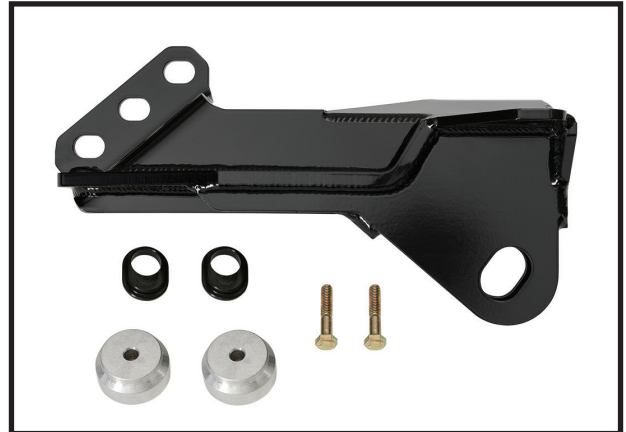

WARNING!
<p>** READ ALL INSTRUCTIONS THOROUGHLY FROM START TO FINISH BEFORE BEGINNING INSTALLATION! IF THESE INSTRUCTIONS ARE NOT PROPERLY FOLLOWED SEVERE FRAME, SUSPENSION AND TIRE DAMAGE MAY RESULT TO THE VEHICLE!</p> <p>** ICON VEHICLE DYNAMICS RECOMMENDS THAT YOU EXERCISE EXTREME CAUTION WHEN WORKING UNDER A VEHICLE THAT IS SUPPORTED WITH JACK STANDS.</p> <p>** ICON VEHICLE DYNAMICS RECOMMENDS ALL INSTALLATION TO BE PERFORMED BY A PROFESSIONAL SHOP/SERVICE TECHNICIAN. PRODUCT FAILURE CAUSED BY IMPROPER INSTALLATION WILL NOT BE COVERED UNDER ICON'S WARRANTY POLICY.</p>

INSTALLATION

- Using a properly rated jack, raise the front of the vehicle and support the frame rails with jack stands. Ensure the jack stands are secure and set properly before lowering the jack. Never work under an unsupported vehicle. Remove the front wheels and tires.
- Disconnect the track bar from the factory frame bracket using a 30mm wrench/socket. [FIGURE 1]

FIG.1

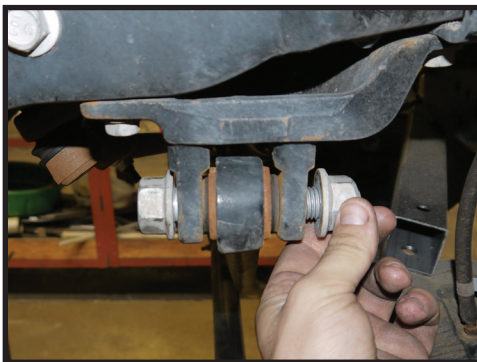
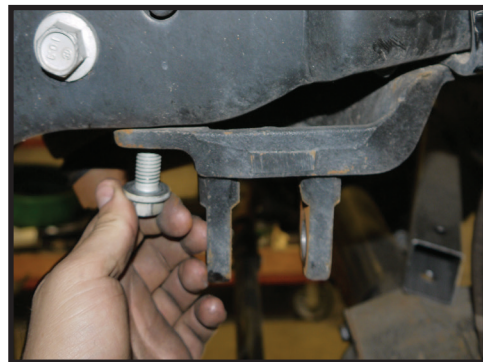

FIG.2



- Remove the stock track bar bracket: Remove the (2) bolts going up into the bottom of the frame rail using an 18mm and the (3) nuts on the engine crossmember using a 21mm. Remove the stud plate from the crossmember and remove the track bar bracket. [FIGURE 2]

4. Install the new track bar bracket using the factory hardware. Hold the bracket up to position and insert the stud plate through the crossmember and bracket. Use a small amount of blue thread locker on the threads and install the (3) nuts loosely. [FIGURE 3]



FIG.3

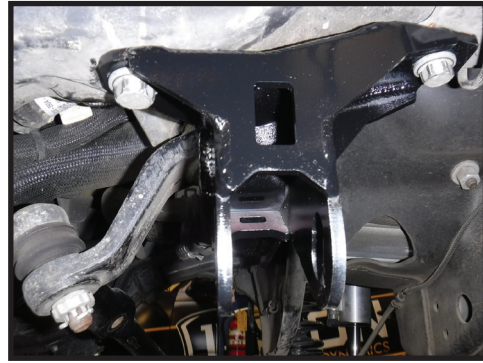

FIG.4

5. Apply a small amount of thread locker on the frame bolts and install them. There are nut plates inside the frame that stick out of the holes on the inside. Hold the nut plates in place to assist with threading the bolts in. [Torque to factory spec] [FIGURE 4]

6. If bracket is being installed along with the ICON's 4.5" box kit (64050) refer to those instructions now.

7. Install the track bar into place. Be sure that the adjustment cam is in the correct position for the lift kit being installed: 2.5" lifts require the cam to be positioned so that the hole is offset to the highest position. 4.5" lifts require the cam to be positioned so that the hole is offset to the lowest position. [FIGURE 5]

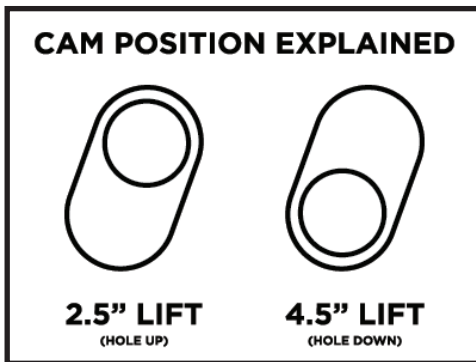

FIG.5



FIG.6

8. Use a small amount of thread locker on the bolt and nut then torque to factory spec. You may need to raise or lower the axle with a jack to align the track bar with the mounting holes (4.5" POSITION SHOWN). [FIGURE 6]

9. Pry the front bump stops out of the bump stop cups then remove the bolt in the center of the cup using a 10mm.

10. Install the new bump stop spacer between the factory cup and frame using the supplied bolt. Rotate the cup so the flat side is nearest to the coil for added clearance. (REFER TO TECH NOTES BEFORE INSTALLING THE BUMP STOP SPACER) [Torque to factory spec] [FIGURE 7]



FIG.7

11. Push the bump stops back into the cups until they snap/lock into place.

12. Reinstall the wheels and lower the vehicle to the ground. [Torque lug nuts to factory spec]

13. Have the vehicle professionally aligned.

VERIFY ALL FASTENERS ARE PROPERLY TORQUED BEFORE DRIVING VEHICLE.

RETORQUE ALL NUTS, BOLTS AND LUGS AFTER 100 MILES AND PERIODICALLY THEREAFTER.

ICON VEHICLE DYNAMICS LIMITED LIFETIME WARRANTY

ICON Vehicle Dynamics warrants to the original retail purchaser who owns the vehicle on which the product was originally installed. ICON Vehicle Dynamics does not warrant the product for finish, alterations, modifications and/or installation contrary to ICON Vehicle Dynamics instructions. ICON Vehicle Dynamics products are not designed, nor are they intended to be installed on vehicles used in race applications, for racing purposes or for similar activities. (A "race" is defined as any contest between two or more vehicles, or a contest of one or more vehicles against the clock, whether or not such contest is for a prize). This warranty does not include coverage for police or taxi vehicles, race vehicles, or vehicles used for government or commercial purposes. Also excluded from this warranty are sales outside of the United States of America and Canada.

ICON Vehicle Dynamics' obligation under this warranty is limited to the repair or replacement, at ICON Vehicle Dynamics' discretion, of the defective product. Any and all costs of removal, installation or re-installation, freight charges and incidental or consequential damages are expressly excluded from this warranty. Items that are subject to wear are not considered defective when worn and are not covered.

ICON Vehicle Dynamics components must be installed as a complete kit as shown in our current application guide. Any substitutions or exemptions of required components will immediately void the warranty. Some finish damage may happen to parts during shipping and is not covered under warranty.

This warranty is expressly in lieu of all other warranties expressed or implied. This warranty shall not apply to any product that has been improperly installed, modified or customized subject to accident, negligence, abuse or misuse.

ICON VEHICLE DYNAMICS LIABILITY DISCLAIMER

ICON does not make any representations or warranties regarding the fitness of any ICON product for a particular installation or conformance of any ICON product with a particular vehicle application. Installation of any ICON suspension system is at the sole discretion of the end user and in making a purchase of any ICON suspension system, the purchaser assumes the responsibility and liability for any and all damage or injury, of any kind or nature whatsoever, caused by, resulting from, arising out of, or occurring in connection with the use or installation of any ICON suspension system. ICON is not liable for and specifically disavows any installation that is not in conformance with original equipment manufacturer's recommendations or instructions. Purchaser agrees that in the event of any claim or lawsuit arising out of the installation or use of an ICON suspension system, purchaser shall indemnify and hold harmless ICON, its agents, employees, officers and owners from and against any and all loss, expense, damage or injury that ICON may sustain as the result of such claim. [If applicable, ICON defers to and recommends recalibration of any/all vehicle stability systems after suspension installation.]



ICON VEHICLE DYNAMICS®
PERFORMANCE SUSPENSION SYSTEMS AND SHOCK ABSORBERS

7929 Lincoln Ave. Riverside, CA 92504 Phone: 951.689.ICON Fax: 951.689.1016
www.iconvehicledynamics.com



FOLLOW US ON FACEBOOK!



7929 Lincoln Ave. Riverside, CA 92504
Phone: 951.689.ICON | Fax: 951.689.1016

PART #	DESCRIPTION
65053	23 FSD 2.5 CENTERLINE STABILIZER KIT

COMPONENTS INCLUDED	
(1) 164053 23 FSD THRU SHAFT SS, DIFF BRACKET	(1) 164952 05-UP FSD 4WD STAB 2.5 PB UPKG
HARDWARE INCLUDED	
(4) 605056 1/4-20 X 1.750 SHCS 18-8 (4) M8-1.25 X 40MM FLANGE BOLT BPHOS (1) 605306 1/2-13 X 2.500 HHCS	(1) 605330 1/2 SAE FLAT WASHER (1) 605333 1/2-13 FLANGED NYLOCK NUT (1) 297206 44MM BILLET TUBE CLAMP FRONT
TOOLS REQUIRED	
TORQUE WRENCH TAPE MEASURE 13MM SOCKET / WRENCH	3/16" ALLEN WRENCH 3/4" SOCKET / WRENCH
TECH NOTES	
<ol style="list-style-type: none"> 1. AFTER INSTALLATION, CYCLE STEERING LEFT AND RIGHT TO ENSURE FULL RANGE OF STEERING IS ACHIEVABLE AND STABILIZER IS INSTALLED CORRECTLY. 2. USE THE SUPPLIED 1" FRONT BUMP STOP SPACERS UNLESS THE SUSPENSION SYSTEM THAT YOU ARE USING CALLS FOR LARGER BUMP STOP SPACERS. IF USING A NON-ICON CONFIGURATION, CYCLE THE SUSPENSION TO VERIFY THAT THE STABILIZER DOES NOT MAKE CONTACT UPON FULL COMPRESSION. 3. MOUNTS OVER STOCK FRON DIFFERENTIAL COVER, NOT COMPATIBLE WITH MOST AFTERMARKET COVERS. 4. NOT COMPATIBLE WITH AFTERMARKET TIE RODS 5. ONLY COMPATIBLE WITH 4WD MODELS 	



WARNING!
<p>** READ ALL INSTRUCTIONS THOROUGHLY FROM START TO FINISH BEFORE BEGINNING INSTALLATION! IF THESE INSTRUCTIONS ARE NOT PROPERLY FOLLOWED SEVERE FRAME, SUSPENSION AND TIRE DAMAGE MAY RESULT TO THE VEHICLE!</p> <p>** ICON VEHICLE DYNAMICS RECOMMENDS THAT YOU EXERCISE EXTREME CAUTION WHEN WORKING UNDER A VEHICLE THAT IS SUPPORTED WITH JACK STANDS.</p> <p>** ICON VEHICLE DYNAMICS RECOMMENDS ALL INSTALLATION TO BE PERFORMED BY A PROFESSIONAL SHOP/SERVICE TECHNICIAN. PRODUCT FAILURE CAUSED BY IMPROPER INSTALLATION WILL NOT BE COVERED UNDER ICON'S WARRANTY POLICY.</p>

INSTALLATION

1. Remove the (4) highlighted bolts from the differential cover using a 13MM socket/wrench. [FIGURE 1]

FIG.1

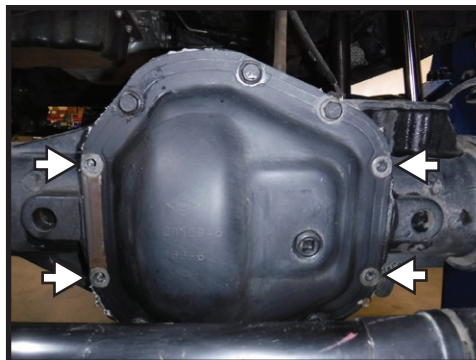

2. Install the steering stabilizer bracket over the differential cover using the supplied M8-1.25 bolts. Tighten using a 13MM socket/wrench. [Torque to factory spec] [FIGURE 2]

FIG.2



3. Set the steering stabilizer so there is 4.340" of dead shaft showing. [FIGURE 3]

FIG.3



4. Install the steering stabilizer with the rod end side into the bracket using the supplied 1/2" hardware and a 3/4" socket/wrench. [Torque to 80 ft-lbs] [FIGURE 4]

FIG.4



5. Install stabilizer clamp onto the tie rod, being sure not to extend or collapse the stabilizer. Make sure steering wheel and tires are straight/centered. Use the (4) supplied 1/4-20 allen bolts to tighten the tube clamp using a 3/16" allen wrench. Being sure to tighten it evenly. Keep stabilizer parallel with tie rod while tightening [Torque to 8 ft-lbs]. Be sure the reservoir is position at 45°. [FIGURE 5]

FIG.5



6. After installation, cycle steering left and right to ensure full range of steering is achievable and stabilizer is installed correctly.



VERIFY ALL FASTENERS ARE PROPERLY TORQUED BEFORE DRIVING VEHICLE.

RETORQUE ALL NUTS, BOLTS AND LUGS AFTER 100 MILES AND PERIODICALLY THEREAFTER.

ICON VEHICLE DYNAMICS LIMITED LIFETIME WARRANTY

ICON Vehicle Dynamics warrants to the original retail purchaser who owns the vehicle on which the product was originally installed. ICON Vehicle Dynamics does not warrant the product for finish, alterations, modifications and/or installation contrary to ICON Vehicle Dynamics instructions. ICON Vehicle Dynamics products are not designed, nor are they intended to be installed on vehicles used in race applications, for racing purposes or for similar activities. (A "race" is defined as any contest between two or more vehicles, or a contest of one or more vehicles against the clock, whether or not such contest is for a prize). This warranty does not include coverage for police or taxi vehicles, race vehicles, or vehicles used for government or commercial purposes. Also excluded from this warranty are sales outside of the United States of America and Canada.

ICON Vehicle Dynamics' obligation under this warranty is limited to the repair or replacement, at ICON Vehicle Dynamics' discretion, of the defective product. Any and all costs of removal, installation or re-installation, freight charges and incidental or consequential damages are expressly excluded from this warranty. Items that are subject to wear are not considered defective when worn and are not covered.

ICON Vehicle Dynamics components must be installed as a complete kit as shown in our current application guide. Any substitutions or exemptions of required components will immediately void the warranty. Some finish damage may happen to parts during shipping and is not covered under warranty.

This warranty is expressly in lieu of all other warranties expressed or implied. This warranty shall not apply to any product that has been improperly installed, modified or customized subject to accident, negligence, abuse or misuse.



ICON VEHICLE DYNAMICS®
PERFORMANCE SUSPENSION SYSTEMS AND SHOCK ABSORBERS

7929 Lincoln Ave. Riverside, CA 92504 Phone: 951.689.ICON Fax: 951.689.1016
www.iconvehicledynamics.com



FOLLOW US ON FACEBOOK!



7929 Lincoln Ave. Riverside, CA 92504
Phone: 951.689.ICON | Fax: 951.689.1016

PART #	DESCRIPTION
67811EP	23 FSD 4WD 4.5" FRONT 2.5 VS RR CDEV PAIR

COMPONENTS INCLUDED	
(2) 164953E-AL 23 FSD 4.5" FRONT AL RR CDEV (2) 160085 05-UP FSD RESI MT COIL BUCKET	(2) 611006 9/16" HD STEM BUSHING KIT (1) 611051 #40 2 1/16-3" HOSE CLAMP KIT
HARDWARE INCLUDED	
(1) 255604-06 EXTENSION HARNESS COIL IIC CONTROLLER 6-FT	(1) 255604-14 EXTENSION HARNESS COIL IIC CONTROLLER 14-FT
611006 HARDWARE KIT	
(2) HEAVY DUTY 9/16 ID STEM BUSHING (1) HEAVY DUTY 9/16 ID STEM WASHER (1) HEAVY DUTY 12MM ID STEM WASHER	(1) M12-1.25 NUT (1) M12-1.25 JAM NUT
611051 HARDWARE KIT	
(4) 605931 1/2 X 2 1/16-3 ID #40 SS HOSE CLAMP	
TOOLS REQUIRED	
JACK JACK STANDS PLIERS DRILL 11/32" DRILL BIT TORQUE WRENCH	5/16" SOCKET / WRENCH 9/16" SOCKET / WRENCH 17MM SOCKET / WRENCH 18MM SOCKET / WRENCH 19MM SOCKET / WRENCH
TECH NOTES	
1. YOUR ICON SHOCK ASSEMBLIES COME FACTORY CHARGED TO 250 PSI. RELEASING NITROGEN PRESSURE MAY LEAD TO SHOCK MALFUNCTION AND REDUCED RIDE QUALITY. FAILURE CAUSED BY LOW NITROGEN PRESSURE IS NOT COVERED UNDER ICON'S WARRANTY POLICY.	
2. ESTIMATED INSTALL TIME: 3-4 HOURS	



WARNING!

**** READ ALL INSTRUCTIONS THOROUGHLY FROM START TO FINISH BEFORE BEGINNING INSTALLATION! IF THESE INSTRUCTIONS ARE NOT PROPERLY FOLLOWED SEVERE FRAME, SUSPENSION AND TIRE DAMAGE MAY RESULT TO THE VEHICLE!**

**** ICON VEHICLE DYNAMICS RECOMMENDS THAT YOU EXERCISE EXTREME CAUTION WHEN WORKING UNDER A VEHICLE THAT IS SUPPORTED WITH JACK STANDS.**

**** ICON VEHICLE DYNAMICS RECOMMENDS ALL INSTALLATION TO BE PERFORMED BY A PROFESSIONAL SHOP/SERVICE TECHNICIAN. PRODUCT FAILURE CAUSED BY IMPROPER INSTALLATION WILL NOT BE COVERED UNDER ICON'S WARRANTY POLICY.**

INSTALLATION

- Using a properly rated jack, raise the front of the vehicle and support the frame rails with jack stands. Ensure the jack stands are secure and set properly before lowering the jack. NEVER WORK UNDER AN UNSUPPORTED VEHICLE. Remove the front wheels.
- Use a jack to support the axle and then remove the factory shock using a 17mm and 18mm socket/wrench.
- Remove the sway bar links from the sway bar using an 18mm socket/wrench. Leave them connected to the differential. [FIGURE 1]

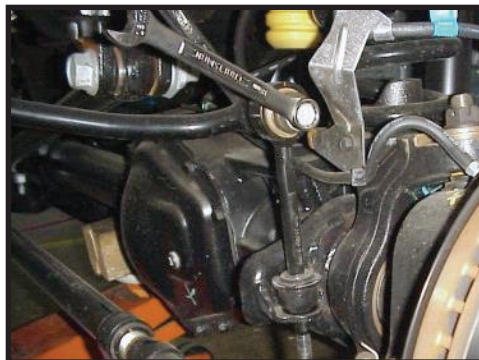

FIG.1

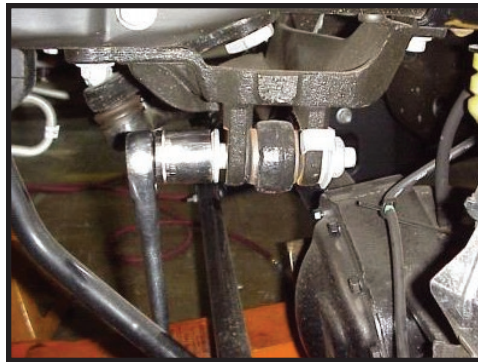

FIG.2

- Disconnect the upper brake line brackets from the frame using a 13mm socket/wrench and lower brake line brackets from the differential using a 10mm socket/wrench. [FIGURE 2]

5. On the driver side of the track bar, remove the nut and the upper track bar bolt using (2) 30mm socket/wrenches. [FIGURE 3]

FIG.3



6. Slowly lower the axle, the coils will unload from the mounts and can be removed. Be careful not to stretch or damage any lines connected to the axle or radius arms.

7. Lower the axle enough to install the reservoir mount (PN 160085) between the coil bucket and the coil isolator.

8. Raise the axle using a floor jack

9. Install stem hardware as seen in diagram. Install (605810) tall nut and fasten bushing assembly until 3-4 threads are exposed for the (605809) jam nut. Install (605809) nut and torque to 50 ft-lbs while holding (605810) with a 19mm wrench. Do not overtighten bushing assembly as this can lead to premature bushing wear. Failure caused by incorrect installation of bushings is not covered under ICON's warranty policy. Install the wide heim spacer so that it orients the shock further away from the frame and then install the factory lower bolt using an 18mm socket/wrench. [Torque to factory spec] [SEE DIAGRAM]

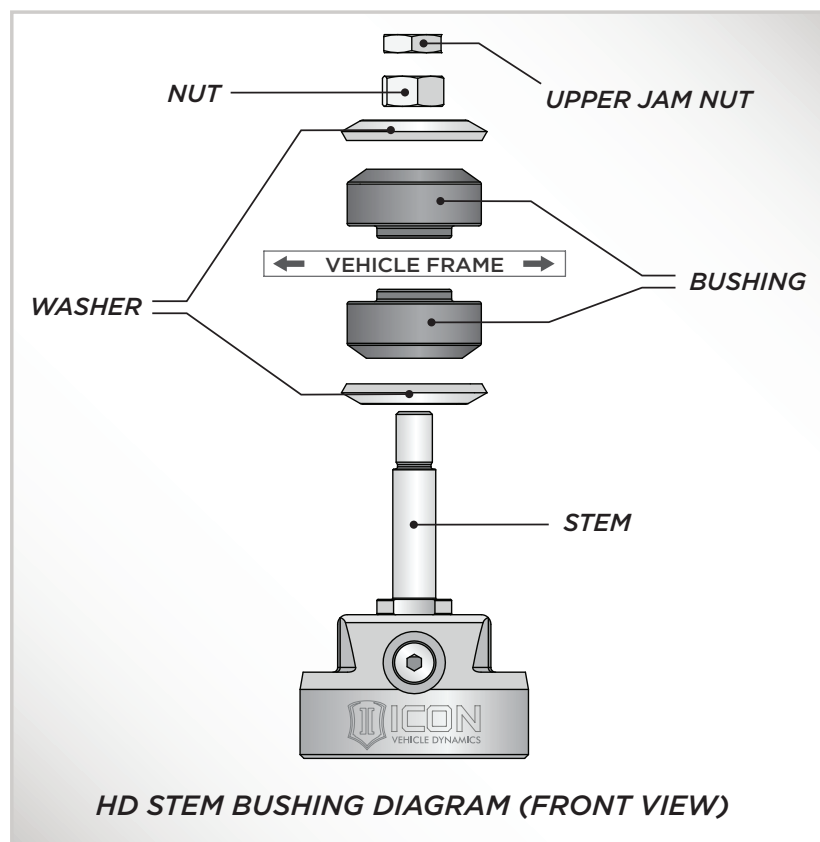

10. If installing coilover conversion, use the doubler reservoir mount (supplied in coilover kit) for mounting both reservoirs as shown. [FIGURE 4]

FIG.4



11. Mount the reservoir to the bracket using a 5/16" nut driver and the supplied (605931) hose clamps. [FIGURE 5]

FIG.5



12. Connect the sway bar links to the sway bar using an 18mm socket/wrench. [Torque to factory spec]

13. Reconnect the upper brake line bracket to the frame using a 13mm socket/wrench and the lower bracket using a 10mm socket/wrench [Torque to factory spec]. Depending on the year of the truck, the brake line may need to be manipulated down to not overextend at full droop.

14. Reconnect the track bar using (2) 30mm socket/wrenches. [Torque to factory spec]

15. Install wheels and lower vehicle to the ground. [Torque lugs to factory spec]

16. Refer to IIC install instructions for wire installation.

17. Have the vehicle professionally aligned.

VERIFY ALL FASTENERS ARE PROPERLY TORQUED BEFORE DRIVING VEHICLE.

RETORQUE ALL NUTS, BOLTS AND LUGS AFTER 100 MILES AND PERIODICALLY THEREAFTER.

2.5 VS SERIES SHOCK & COILOVER TECHNICAL INFORMATION

MAINTENANCE

ICON shock absorbers are a high quality rebuildable race style shock absorber designed for optimal performance. With a unit of this caliber on your vehicle, routine maintenance is required to keep them looking and operating in like new condition. Residual oil and assembly lube may be present at all seal paths from the factory out of the box and is considered normal. Pooling of oil however is not acceptable at any time and one should contact the ICON dealer where purchased.

BELOW ARE GUIDELINES BASED ON HOW YOU USE YOUR VEHICLE BUT YOUR MILEAGE MAY VARY:

STREET USE:

- Send in for factory servicing every 40,000 miles or if a leak develops, ride quality decreases, or they begin to make excessive noise.
- Remove any buildup of road salt, mud, or debris from shocks and coil springs anytime accrued
- Clean with mild soap and water with each oil change or anytime you notice build up.
- Wax the cylinders yearly with automotive wax to prevent corrosion.
- Check nitrogen pressure yearly. (252004 charge needle assembly available at any ICON distributor)
- Check bearings for excessive wear yearly.
- DO NOT apply any type of lube to the upper and lower bearings.

STREET/DIRT:

- Send in for factory servicing every 15,000 miles or if a leak develops, ride quality decreases, or they begin to make excessive noise.
- Clean with mild soap and water with each oil change, offroad trip, or anytime you notice build up.
- Wax the cylinders yearly with automotive wax to prevent corrosion.
- Check nitrogen pressure each dirt outing. (252004 charge needle assembly available at any ICON distributor)
- Check bearings for excessive wear yearly.
- DO NOT apply any type of lube to the upper and lower bearings.

DIRT USE:

- Send in for factory servicing every 1,000 miles.
- Check nitrogen pressure each outing. (252004 charge needle assembly available at any ICON distributor)
- Remove any buildup of mud or debris from shocks and coil springs after every outing.

SELF-SERVICE:

- Contact ICON for service kits & tools at (951) 689-4266.

PRODUCT REGISTRATION

Please visit: <http://www.iconvehicledynamics.com/tech-support/registration/> to register your product.

ICON VEHICLE DYNAMICS SHOCK ABSORBER WARRANTY

This shock absorber has a 1 year warranty against any manufacturer's defects. If a shock fails within the initial year of ownership, the shock must be shipped to ICON Vehicle Dynamics for inspection and service. If a shock is inspected and it has been determined the shock failed due to neglect, damage caused by improper installation or any other reason besides "normal wear and tear", the owner of said shock is responsible for all service costs. This includes labor, parts, and shipping.

ICON Vehicle Dynamics warrants to the original retail purchaser who owns the vehicle on which the product was originally installed. ICON Vehicle Dynamics does not warrant the product for finish, alterations, modifications and/or installation contrary to ICON Vehicle Dynamics instructions. ICON Vehicle Dynamics products are not designed, nor are they intended to be installed on vehicles used in race applications, for racing purposes or for similar activities. (A "race" is defined as any contest between two or more vehicles, or a contest of one or more vehicles against the clock, whether or not such contest is for a prize). This warranty does not include coverage for police or taxi vehicles, race vehicles, or vehicles used for government or commercial purposes. Also excluded from this warranty are sales outside of the United States of America and Canada.

ICON Vehicle Dynamics' obligation under this warranty is limited to the repair or replacement, at ICON Vehicle Dynamics' discretion, of the defective product. Any and all costs of removal, installation or re-installation, freight charges and incidental or consequential damages are expressly excluded from this warranty. Items that are subject to wear are not considered defective when worn and are not covered.

ICON Vehicle Dynamics components must be installed as a complete kit as shown in our current application guide. Any substitutions or exemptions of required components will immediately void the warranty. Some finish damage may happen to parts during shipping and is not covered under warranty.

This warranty is expressly in lieu of all other warranties expressed or implied. This warranty shall not apply to any product that has been improperly installed, modified or customized subject to accident, negligence, abuse or misuse.

To send a shock in for warranty please visit our website <http://www.iconvehicledynamics.com/tech-support/shock-service/>



ICON VEHICLE DYNAMICS®
PERFORMANCE SUSPENSION SYSTEMS AND SHOCK ABSORBERS

7929 Lincoln Ave. Riverside, CA 92504 Phone: 951.689.ICON Fax: 951.689.1016
www.iconvehicledynamics.com



FOLLOW US ON FACEBOOK!

