

7929 Lincoln Ave. Riverside, CA 92504
Phone: 951.689.ICON | Fax: 951.689.1016

PART #	DESCRIPTION
37705CP	99-UP FSD 4WD 0-3" REAR 2.5 VS PB CDCV PAIR

COMPONENTS INCLUDED	
(2) 134944PBC 99-UP FSD 4WD REAR 2.5 VS PB CDCV	
HARDWARE INCLUDED	
N/A	
TOOLS REQUIRED	
JACK JACK STANDS TORQUE WRENCH	18MM SOCKET / WRENCH 21MM SOCKET / WRENCH
TECH NOTES	
<p>1. YOUR ICON SHOCK ASSEMBLIES COME FACTORY CHARGED TO 150 PSI. RELEASING NITROGEN PRESSURE MAY LEAD TO SHOCK MALFUNCTION AND REDUCED RIDE QUALITY. FAILURE CAUSED BY LOW NITROGEN PRESSURE IS NOT COVERED UNDER ICON'S WARRANTY POLICY.</p> <p>2. THE LOWER HEIM SPACERS FOR 99-16 AND 17-UP ARE INCLUDED. USE THE 14MM SPACERS FOR 17-UP APPLICATIONS.</p>	



WARNING!
<p>** READ ALL INSTRUCTIONS THOROUGHLY FROM START TO FINISH BEFORE BEGINNING INSTALLATION! IF THESE INSTRUCTIONS ARE NOT PROPERLY FOLLOWED SEVERE FRAME, SUSPENSION AND TIRE DAMAGE MAY RESULT TO THE VEHICLE!</p> <p>** ICON VEHICLE DYNAMICS RECOMMENDS THAT YOU EXERCISE EXTREME CAUTION WHEN WORKING UNDER A VEHICLE THAT IS SUPPORTED WITH JACK STANDS.</p> <p>** ICON VEHICLE DYNAMICS RECOMMENDS ALL INSTALLATION TO BE PERFORMED BY A PROFESSIONAL SHOP/SERVICE TECHNICIAN. PRODUCT FAILURE CAUSED BY IMPROPER INSTALLATION WILL NOT BE COVERED UNDER ICON'S WARRANTY POLICY.</p>

INSTALLATION

- Using a properly rated jack, raise the front of the vehicle and support the frame rails with jack stands. Ensure the jack stands are secure and set properly before lowering the jack. NEVER WORK UNDER AN UNSUPPORTED VEHICLE.
- Remove the factory shocks using 18mm and 21mm socket/wrench.
- Slide the wider spacer onto the stud on the upper shock mount. Slide the shock into the shock mount with the reservoir facing away from the axle. The driver side reservoir may need to be clocked (toward the spare tire) away from a wiring harness. Slide the wide spacer on to the stud, followed by the upper shock eyelet, then the narrow spacer. [Torque to factory spec] [FIGURE 1 & 2]

FIG.1



FIG.2



4. Position the rod end in the lower mount and slide the bolt in. There are 2 sets of lower spacers provided. 99-16 FSDs have a 12mm bolt. 17-UP FSDs have 14mm bolt. Use the correct spacers for your vehicle. If using the 14mm bolt, offset the rod end toward the wheel. [Torque to factory spec] [FIGURE 3]

FIG.3



VERIFY ALL FASTENERS ARE PROPERLY TORQUED BEFORE DRIVING VEHICLE.

RETORQUE ALL NUTS, BOLTS AND LUGS AFTER 100 MILES AND PERIODICALLY THEREAFTER.

2.5 VS SERIES SHOCK & COILOVER TECHNICAL INFORMATION

MAINTENANCE

ICON shock absorbers are a high quality rebuildable race style shock absorber designed for optimal performance. With a unit of this caliber on your vehicle, routine maintenance is required to keep them looking and operating in like new condition. Residual oil and assembly lube may be present at all seal paths from the factory out of the box and is considered normal. Pooling of oil however is not acceptable at any time and one should contact the ICON dealer where purchased.

BELOW ARE GUIDELINES BASED ON HOW YOU USE YOUR VEHICLE BUT YOUR MILEAGE MAY VARY:

STREET USE:

- Send in for factory servicing every 40,000 miles or if a leak develops, ride quality decreases, or they begin to make excessive noise.
- Remove any buildup of road salt, mud, or debris from shocks and coil springs anytime accrued
- Clean with mild soap and water with each oil change or anytime you notice build up.
- Wax the cylinders yearly with automotive wax to prevent corrosion.
- Check nitrogen pressure yearly. (252004 charge needle assembly available at any ICON distributor)
- Check bearings for excessive wear yearly.
- DO NOT apply any type of lube to the upper and lower bearings.

STREET/DIRT:

- Send in for factory servicing every 15,000 miles or if a leak develops, ride quality decreases, or they begin to make excessive noise.
- Clean with mild soap and water with each oil change, offroad trip, or anytime you notice build up.
- Wax the cylinders yearly with automotive wax to prevent corrosion.
- Check nitrogen pressure each dirt outing. (252004 charge needle assembly available at any ICON distributor)
- Check bearings for excessive wear yearly.
- DO NOT apply any type of lube to the upper and lower bearings.

DIRT USE:

- Send in for factory servicing every 1,000 miles.
- Check nitrogen pressure each outing. (252004 charge needle assembly available at any ICON distributor)
- Remove any buildup of mud or debris from shocks and coil springs after every outing.

SELF-SERVICE:

- Contact ICON for service kits & tools at (951) 689-4266.

PRODUCT REGISTRATION

Please visit: <http://www.iconvehicledynamics.com/tech-support/registration/> to register your product.

ICON VEHICLE DYNAMICS SHOCK ABSORBER WARRANTY

This shock absorber has a 1 year warranty against any manufacturer's defects. If a shock fails within the initial year of ownership, the shock must be shipped to ICON Vehicle Dynamics for inspection and service. If a shock is inspected and it has been determined the shock failed due to neglect, damage caused by improper installation or any other reason besides "normal wear and tear", the owner of said shock is responsible for all service costs. This includes labor, parts, and shipping.

ICON Vehicle Dynamics warrants to the original retail purchaser who owns the vehicle on which the product was originally installed. ICON Vehicle Dynamics does not warrant the product for finish, alterations, modifications and/or installation contrary to ICON Vehicle Dynamics instructions. ICON Vehicle Dynamics products are not designed, nor are they intended to be installed on vehicles used in race applications, for racing purposes or for similar activities. (A "race" is defined as any contest between two or more vehicles, or a contest of one or more vehicles against the clock, whether or not such contest is for a prize). This warranty does not include coverage for police or taxi vehicles, race vehicles, or vehicles used for government or commercial purposes. Also excluded from this warranty are sales outside of the United States of America and Canada.

ICON Vehicle Dynamics' obligation under this warranty is limited to the repair or replacement, at ICON Vehicle Dynamics' discretion, of the defective product. Any and all costs of removal, installation or re-installation, freight charges and incidental or consequential damages are expressly excluded from this warranty. Items that are subject to wear are not considered defective when worn and are not covered.

ICON Vehicle Dynamics components must be installed as a complete kit as shown in our current application guide. Any substitutions or exemptions of required components will immediately void the warranty. Some finish damage may happen to parts during shipping and is not covered under warranty.

This warranty is expressly in lieu of all other warranties expressed or implied. This warranty shall not apply to any product that has been improperly installed, modified or customized subject to accident, negligence, abuse or misuse.

To send a shock in for warranty please visit our website <http://www.iconvehicledynamics.com/tech-support/shock-service/>

7929 Lincoln Ave. Riverside, CA 92504
Phone: 951.689.ICON | Fax: 951.689.1016

PART #	DESCRIPTION
64012	23 FORD F-250/F-350 FRONT 4.5" GAS DUAL RATE SPRING KIT

COMPONENTS INCLUDED	
(2) 168501 05-19 FSD FRONT 4.5" LIFT DUAL RATE COIL SPRING	
HARDWARE INCLUDED	
N/A	
TOOLS REQUIRED	
JACK JACK STANDS PLIERS TORQUE WRENCH HAMMER BALL JOINT SEPARATOR	SPRING COMPRESSOR 3/4" SOCKET / WRENCH 13MM SOCKET / WRENCH 18MM SOCKET / WRENCH 21MM SOCKET / WRENCH 30MM SOCKET / WRENCH
TECH NOTES	
<p>1. LIFT HEIGHTS ARE BASED ON CREW CAB DIESEL ENGINE F-250 CONFIGURATIONS.</p> <p>2. ICON 4.5" COIL SPRINGS MUST BE INSTALLED IN CONJUNCTION WITH AN ICON 4.5" RADIUS ARM OR 4-LINK KIT.</p> <p>3. ESTIMATED INSTALL TIME: 2 HOURS</p>	



WARNING!
<p>** READ ALL INSTRUCTIONS THOROUGHLY FROM START TO FINISH BEFORE BEGINNING INSTALLATION! IF THESE INSTRUCTIONS ARE NOT PROPERLY FOLLOWED SEVERE FRAME, SUSPENSION AND TIRE DAMAGE MAY RESULT TO THE VEHICLE!</p> <p>** ICON VEHICLE DYNAMICS RECOMMENDS THAT YOU EXERCISE EXTREME CAUTION WHEN WORKING UNDER A VEHICLE THAT IS SUPPORTED WITH JACK STANDS.</p> <p>** ICON VEHICLE DYNAMICS RECOMMENDS ALL INSTALLATION TO BE PERFORMED BY A PROFESSIONAL SHOP/SERVICE TECHNICIAN. PRODUCT FAILURE CAUSED BY IMPROPER INSTALLATION WILL NOT BE COVERED UNDER ICON'S WARRANTY POLICY.</p>

INSTALLATION

- Using a properly rated jack, raise the front of the vehicle and support the frame rails with jack stands. Ensure the jack stands are secure and set properly before lowering the jack. NEVER WORK UNDER AN UNSUPPORTED VEHICLE. Remove front wheels.
- Remove the sway bar links from the sway bar using an 18mm socket/wrench. Leave them connected to the differential. [FIGURE 1]

FIG.1

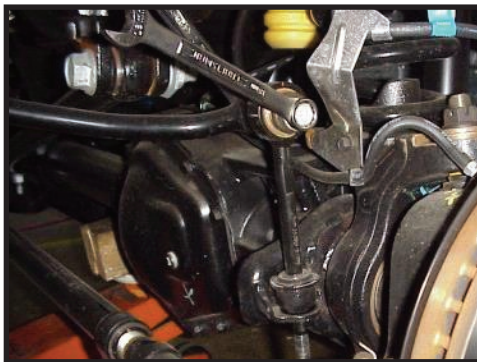
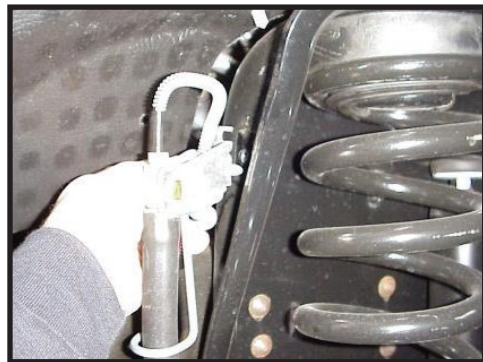

FIG.2



- Disconnect the upper brake line brackets from the frame using a 13mm socket/wrench and lower brake line brackets from the differential using a 10mm socket/wrench. [FIGURE 2]

- 4.** On the driver side of the track bar, remove the nut and the upper track bar bolt using (2) 30mm socket/wrenches. **[FIGURE 3]**

FIG.3

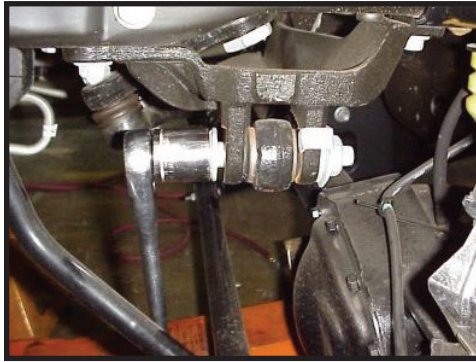

- 5.** Support the axle with a floor jack and remove the front shocks. The shocks are limiting droop so make sure that the axle is supported or it will fall when the shocks are removed (21mm socket/wrench, 18mm socket/wrench).
- 6.** Slowly lower the axle, the coils will unload from the mounts and can be removed. Be careful not to stretch or damage any lines connected to the axle or radius arms. On 2017-UP models, removing the drag link from the pitman arm may be required. A spring compressor can be used if available, so the axle does not need to be drooped out so far.
- 7.** Lower the axle just enough to install the new springs. Place the original rubber isolator on top of the new coil and install. Be careful to not stretch or damage any lines. Check the rotation/clocking of the coil to make sure it is properly seated in the lower spring perch.
- 8.** Lift the axle high enough to connect the shocks but be careful not to lift the truck off of its supports. Use the original bolt on the lower shock mount and tighten with an 18mm socket/wrench [Torque to factory spec]. Tighten the stem top nut using a 3/4" socket/wrench. (Refer to shock instructions)
- 9.** Connect the sway bar links to the sway bar using an 18mm socket/wrench. [Torque to factory spec]
- 10.** Reconnect the upper brake line bracket to the frame using a 13mm socket/wrench and the lower bracket using a 10mm socket/wrench [Torque to factory spec]. Depending on the truck, the brake line may need to be manipulated down to not overextend at full droop.
- 11.** Reconnect the track bar using (2) 30mm socket/wrenches [Torque to factory spec]. If drag link was removed in step 6, lift axle to ride height and reinstall. [Torque to factory spec]
- 12.** Install the wheels and lower the vehicle to the ground.
- 13.** Have the vehicle professionally aligned.

VERIFY ALL FASTENERS ARE PROPERLY TORQUED BEFORE DRIVING VEHICLE.

RETORQUE ALL NUTS, BOLTS AND LUGS AFTER 100 MILES AND PERIODICALLY THEREAFTER.

ICON VEHICLE DYNAMICS LIMITED LIFETIME WARRANTY

ICON Vehicle Dynamics warrants to the original retail purchaser who owns the vehicle on which the product was originally installed. ICON Vehicle Dynamics does not warrant the product for finish, alterations, modifications and/or installation contrary to ICON Vehicle Dynamics instructions. ICON Vehicle Dynamics products are not designed, nor are they intended to be installed on vehicles used in race applications, for racing purposes or for similar activities. (A "race" is defined as any contest between two or more vehicles, or a contest of one or more vehicles against the clock, whether or not such contest is for a prize). This warranty does not include coverage for police or taxi vehicles, race vehicles, or vehicles used for government or commercial purposes. Also excluded from this warranty are sales outside of the United States of America and Canada.

ICON Vehicle Dynamics' obligation under this warranty is limited to the repair or replacement, at ICON Vehicle Dynamics' discretion, of the defective product. Any and all costs of removal, installation or re-installation, freight charges and incidental or consequential damages are expressly excluded from this warranty. Items that are subject to wear are not considered defective when worn and are not covered.

ICON Vehicle Dynamics components must be installed as a complete kit as shown in our current application guide. Any substitutions or exemptions of required components will immediately void the warranty. Some finish damage may happen to parts during shipping and is not covered under warranty.

This warranty is expressly in lieu of all other warranties expressed or implied. This warranty shall not apply to any product that has been improperly installed, modified or customized subject to accident, negligence, abuse or misuse.



ICON VEHICLE DYNAMICS®
PERFORMANCE SUSPENSION SYSTEMS AND SHOCK ABSORBERS

7929 Lincoln Ave. Riverside, CA 92504 Phone: 951.689.ICON Fax: 951.689.1016
www.iconvehicledynamics.com



FOLLOW US ON FACEBOOK!



7929 Lincoln Ave. Riverside, CA 92504
 Phone: 951.689.ICON Fax: 951.689.1016

PART #	DESCRIPTION
64038	2017-UP FSD ADJUSTABLE TRACK BAR KIT

COMPONENTS INCLUDED	
(1) 164037 2017-UP FSD ADJUSTABLE TRACK BAR (2) 167021 HEIM SPACER JM16 X .812 X 1.750 (1) 167027 LEFT/RIGHT ADJUSTER ROUND (1) 168001 05-UP TRACK BAR BALL JOINT W/NUT	(1) 295513 JM16-1T, 1-14 LH ROD END F1 FIT (2) 605145 3/8-16 X 1.000 12PT SCREW (1) 605951 SPIRAL RETAINING RING
HARDWARE INCLUDED	
N/A	
TOOLS REQUIRED	
TAPE MEASURE BALL JOINT SEPARATOR HAMMER 1/4" SPANNER WRENCH TORQUE WRENCH	3/8" 12PT SOCKET / WRENCH 13MM SOCKET / WRENCH 27MM SOCKET / WRENCH 30MM SOCKET / WRENCH (2)
TECH NOTES	
1. DO NOT EXCEED 3.375" OF ADJUSTMENT FROM THE CENTER OF THE ROD END TO THE EDGE OF THE TRACK BAR PINCH HOUSING. FAILURE CAUSED BY EXCESSIVE ADJUSTMENT WILL NOT BE COVERED UNDER ICON'S WARRANTY POLICY.	



WARNING!

**** READ ALL INSTRUCTIONS THOROUGHLY FROM START TO FINISH BEFORE BEGINNING INSTALLATION! IF THESE INSTRUCTIONS ARE NOT PROPERLY FOLLOWED SEVERE FRAME, SUSPENSION AND TIRE DAMAGE MAY RESULT TO THE VEHICLE!**

**** ICON VEHICLE DYNAMICS RECOMMENDS THAT YOU EXERCISE EXTREME CAUTION WHEN WORKING UNDER A VEHICLE THAT IS SUPPORTED WITH JACK STANDS.**

**** ICON VEHICLE DYNAMICS RECOMMENDS ALL INSTALLTION TO BE PERFORMED BY A PROFESSIONAL SHOP/SERVICE TECHNICIAN. PRODUCT FAILURE CAUSED BY IMPROPER INSTALLATION WILL NOT BE COVERED UNDER ICON'S WARRANTY POLICY.**

INSTALLATION

1. Remove the stock track bar from the frame bracket using (2) 30mm sockets/wrenches. The vehicle may shift slightly.
2. Remove the track bar from the ball joint taper on the axle. Using a 27mm, remove the nut and separate the ball joint using a ball joint separator and hammer.
3. Connect the ICON track bar to the axle. Use a 13mm to keep the tapered stud from spinning while tightening the nut with a 27mm socket/wrench. [Torque to factory spec] [FIGURE 1]

FIG.1



4. Loosen the pinch bolts using a 3/8" 12pt socket/wrench.
5. Adjust the collar of the track bar while keeping the threaded bushing housing from spinning. Adjust as needed to line up in the frame bracket.

6. Install the factory upper track bar bolt using (2) 30mm sockets/wrenches. [Torque to 406 ft-lbs] [FIGURE 2]

FIG.2



NOTE: This track bar is adjustable from 36.75" - 37.75". The stock track bar measures 36.625" from eye to eye.

7. Adjust the collar to center the axle under the frame. Do not exceed the maximum adjustment range as outlined in the tech notes.

8. Tighten the pinch bolts using an alternating pattern and a 3/8" 12pt socket/wrench. [Torque to 35 ft-lbs]

9. Use the drag link adjustment to center the steering wheel before driving.

10. Have the vehicle professionally aligned.

VERIFY ALL FASTENERS ARE PROPERLY TORQUED BEFORE DRIVING VEHICLE.

RETORQUE ALL NUTS, BOLTS AND LUGS AFTER 100 MILES AND PERIODICALLY THEREAFTER.

ICON VEHICLE DYNAMICS LIMITED LIFETIME WARRANTY

ICON Vehicle Dynamics warrants to the original retail purchaser who owns the vehicle on which the product was originally installed. ICON Vehicle Dynamics does not warrant the product for finish, alterations, modifications and/or installation contrary to ICON Vehicle Dynamics instructions. ICON Vehicle Dynamics products are not designed, nor are they intended to be installed on vehicles used in race applications, for racing purposes or for similar activities. (A "race" is defined as any contest between two or more vehicles, or a contest of one or more vehicles against the clock, whether or not such contest is for a prize). This warranty does not include coverage for police or taxi vehicles, race vehicles, or vehicles used for government or commercial purposes. Also excluded from this warranty are sales outside of the United States of America and Canada.

ICON Vehicle Dynamics' obligation under this warranty is limited to the repair or replacement, at ICON Vehicle Dynamics' discretion, of the defective product. Any and all costs of removal, installation or re-installation, freight charges and incidental or consequential damages are expressly excluded from this warranty. Items that are subject to wear are not considered defective when worn and are not covered.

ICON Vehicle Dynamics components must be installed as a complete kit as shown in our current application guide. Any substitutions or exemptions of required components will immediately void the warranty. Some finish damage may happen to parts during shipping and is not covered under warranty.

This warranty is expressly in lieu of all other warranties expressed or implied. This warranty shall not apply to any product that has been improperly installed, modified or customized subject to accident, negligence, abuse or misuse.

ICON VEHICLE DYNAMICS

PERFORMANCE SUSPENSION SYSTEMS AND SHOCK ABSORBERS

7929 Lincoln Ave. Riverside, CA 92504 Phone: 951.689.ICON Fax: 951.689.1016
www.iconvehicledynamics.com



FOLLOW US ON FACEBOOK!



7929 Lincoln Ave. Riverside, CA 92504
Phone: 951.689.ICON | Fax: 951.689.1016

PART #	DESCRIPTION
64039	08-UP FSD TRACK BAR BUMP STEER BRACKET KIT

COMPONENTS INCLUDED	
(1) 164045 08-UP FSD TRACK BAR BUMP STEER BRACKET (2) 167032 08-UP FSD TRACK BAR BUMP STEER CAM	(2) 167031 05+ FSD 1" BUMP STOP SPACER
HARDWARE INCLUDED	
(2) 605802 M8-1.25 X 40MM HEX HEAD BOLT	
TOOLS REQUIRED	
JACK JACK STANDS TORQUE WRENCH RATCHET BLUE THREAD LOCKER	10MM SOCKET/WRENCH 13MM SOCKET/WRENCH 18MM SOCKET/WRENCH 21MM SOCKET/WRENCH 30MM SOCKET/WRENCH
TECH NOTES	
<p>1. BUMP STEER CORRECTION IS INTENDED FOR 2.5" OR 4.5" LIFTS WITH THE USE OF THE FACTORY TRACK BAR OR ICON TRACK BAR SET TO THE FACTORY LENGTH.</p> <p>2. DEPENDING ON SUSPENSION SYSTEM THAT YOU PURCHASED, YOU MAY END UP WITH MORE THAN ONE SET OF FRONT BUMP STOP SPACERS. INSTALL THE TALLEST OF THE SUPPLIED FRONT BUMP STOP SPACERS WITH THIS BRACKET.</p>	

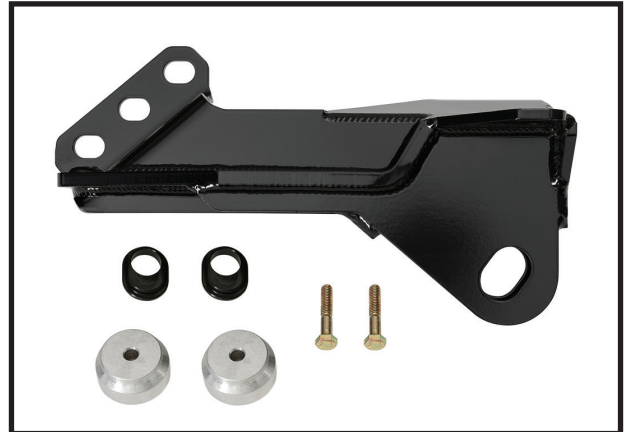

WARNING!
<p>** READ ALL INSTRUCTIONS THOROUGHLY FROM START TO FINISH BEFORE BEGINNING INSTALLATION! IF THESE INSTRUCTIONS ARE NOT PROPERLY FOLLOWED SEVERE FRAME, SUSPENSION AND TIRE DAMAGE MAY RESULT TO THE VEHICLE!</p> <p>** ICON VEHICLE DYNAMICS RECOMMENDS THAT YOU EXERCISE EXTREME CAUTION WHEN WORKING UNDER A VEHICLE THAT IS SUPPORTED WITH JACK STANDS.</p> <p>** ICON VEHICLE DYNAMICS RECOMMENDS ALL INSTALLATION TO BE PERFORMED BY A PROFESSIONAL SHOP/SERVICE TECHNICIAN. PRODUCT FAILURE CAUSED BY IMPROPER INSTALLATION WILL NOT BE COVERED UNDER ICON'S WARRANTY POLICY.</p>

INSTALLATION

- Using a properly rated jack, raise the front of the vehicle and support the frame rails with jack stands. Ensure the jack stands are secure and set properly before lowering the jack. Never work under an unsupported vehicle. Remove the front wheels and tires.
- Disconnect the track bar from the factory frame bracket using a 30mm wrench/socket. [FIGURE 1]

FIG.1

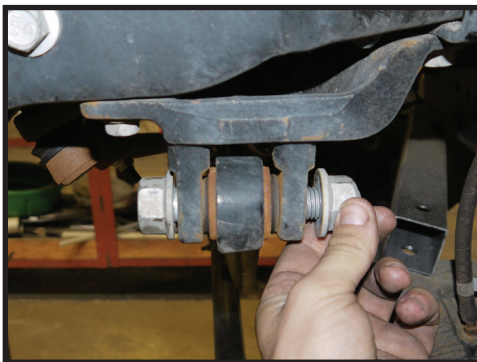
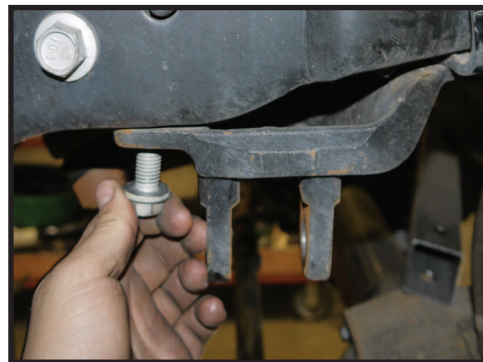

FIG.2



- Remove the stock track bar bracket: Remove the (2) bolts going up into the bottom of the frame rail using an 18mm and the (3) nuts on the engine crossmember using a 21mm. Remove the stud plate from the crossmember and remove the track bar bracket. [FIGURE 2]

4. Install the new track bar bracket using the factory hardware. Hold the bracket up to position and insert the stud plate through the crossmember and bracket. Use a small amount of blue thread locker on the threads and install the (3) nuts loosely. [FIGURE 3]



FIG.3

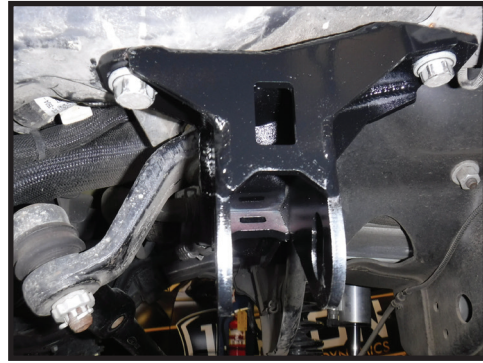

FIG.4

5. Apply a small amount of thread locker on the frame bolts and install them. There are nut plates inside the frame that stick out of the holes on the inside. Hold the nut plates in place to assist with threading the bolts in. [Torque to factory spec] [FIGURE 4]

6. If bracket is being installed along with the ICON's 4.5" box kit (64050) refer to those instructions now.

7. Install the track bar into place. Be sure that the adjustment cam is in the correct position for the lift kit being installed: 2.5" lifts require the cam to be positioned so that the hole is offset to the highest position. 4.5" lifts require the cam to be positioned so that the hole is offset to the lowest position. [FIGURE 5]

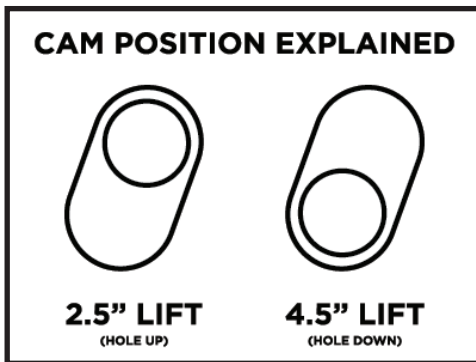

FIG.5



FIG.6

8. Use a small amount of thread locker on the bolt and nut then torque to factory spec. You may need to raise or lower the axle with a jack to align the track bar with the mounting holes (4.5" POSITION SHOWN). [FIGURE 6]

9. Pry the front bump stops out of the bump stop cups then remove the bolt in the center of the cup using a 10mm.

10. Install the new bump stop spacer between the factory cup and frame using the supplied bolt. Rotate the cup so the flat side is nearest to the coil for added clearance. (REFER TO TECH NOTES BEFORE INSTALLING THE BUMP STOP SPACER) [Torque to factory spec] [FIGURE 7]



FIG.7

11. Push the bump stops back into the cups until they snap/lock into place.

12. Reinstall the wheels and lower the vehicle to the ground. [Torque lug nuts to factory spec]

13. Have the vehicle professionally aligned.

VERIFY ALL FASTENERS ARE PROPERLY TORQUED BEFORE DRIVING VEHICLE.

RETORQUE ALL NUTS, BOLTS AND LUGS AFTER 100 MILES AND PERIODICALLY THEREAFTER.

ICON VEHICLE DYNAMICS LIMITED LIFETIME WARRANTY

ICON Vehicle Dynamics warrants to the original retail purchaser who owns the vehicle on which the product was originally installed. ICON Vehicle Dynamics does not warrant the product for finish, alterations, modifications and/or installation contrary to ICON Vehicle Dynamics instructions. ICON Vehicle Dynamics products are not designed, nor are they intended to be installed on vehicles used in race applications, for racing purposes or for similar activities. (A "race" is defined as any contest between two or more vehicles, or a contest of one or more vehicles against the clock, whether or not such contest is for a prize). This warranty does not include coverage for police or taxi vehicles, race vehicles, or vehicles used for government or commercial purposes. Also excluded from this warranty are sales outside of the United States of America and Canada.

ICON Vehicle Dynamics' obligation under this warranty is limited to the repair or replacement, at ICON Vehicle Dynamics' discretion, of the defective product. Any and all costs of removal, installation or re-installation, freight charges and incidental or consequential damages are expressly excluded from this warranty. Items that are subject to wear are not considered defective when worn and are not covered.

ICON Vehicle Dynamics components must be installed as a complete kit as shown in our current application guide. Any substitutions or exemptions of required components will immediately void the warranty. Some finish damage may happen to parts during shipping and is not covered under warranty.

This warranty is expressly in lieu of all other warranties expressed or implied. This warranty shall not apply to any product that has been improperly installed, modified or customized subject to accident, negligence, abuse or misuse.

ICON VEHICLE DYNAMICS LIABILITY DISCLAIMER

ICON does not make any representations or warranties regarding the fitness of any ICON product for a particular installation or conformance of any ICON product with a particular vehicle application. Installation of any ICON suspension system is at the sole discretion of the end user and in making a purchase of any ICON suspension system, the purchaser assumes the responsibility and liability for any and all damage or injury, of any kind or nature whatsoever, caused by, resulting from, arising out of, or occurring in connection with the use or installation of any ICON suspension system. ICON is not liable for and specifically disavows any installation that is not in conformance with original equipment manufacturer's recommendations or instructions. Purchaser agrees that in the event of any claim or lawsuit arising out of the installation or use of an ICON suspension system, purchaser shall indemnify and hold harmless ICON, its agents, employees, officers and owners from and against any and all loss, expense, damage or injury that ICON may sustain as the result of such claim. [If applicable, ICON defers to and recommends recalibration of any/all vehicle stability systems after suspension installation.]



ICON VEHICLE DYNAMICS®
PERFORMANCE SUSPENSION SYSTEMS AND SHOCK ABSORBERS

7929 Lincoln Ave. Riverside, CA 92504 Phone: 951.689.ICON Fax: 951.689.1016
www.iconvehicledynamics.com



FOLLOW US ON FACEBOOK!



7929 Lincoln Ave. Riverside, CA 92504
Phone: 951.689.ICON | Fax: 951.689.1016

PART #	DESCRIPTION
64046	23 FSD RADIUS ARM DROP KIT

COMPONENTS INCLUDED	
(1) 164051 23 FSD RADIUS ARM DROP (DRVR) (1) 164052 23 FSD RADIUS ARM DROP (PASS)	(1) 64046H 23 FSD RADIUS ARM DROP HARDWARE KIT
HARDWARE INCLUDED	
64046H HARDWARE KIT?	
(4) 167029 SLEEVE 1.500 X .525 X .625 RAW (2) 605202 7/16-14 X 1.250 HHCS GR8 YZINC (2) 605220 7/16-14 NYLOCK NUT GR8 YZINC (4) 605230 7/16 SAE FLAT WASHER GR8 YZINC (8) 605357 WASHER 1.500 X .531 X .046 CZINC (2) 605518 5/8-11 X 1.500 HHCS GR8 YZINC (2) 605527 5/8 SPLIT LOCK WASHER GR8 YZINC (2) 605601 3/4-10 X 5.500 HHCS GR8 YZINC (2) 605620 3/4-10 NYLOCK NUT GR8 YZINC	(4) 605630 3/4 SAE FLAT WASHER GR8 YZINC (2) 605823 M12-1.75 NYLOCK NUT GR8.8 CZINC (2) 605849 M12-1.75 X 180MM HHCS GR10.9 YZINC (2) 605821 M18 - 2.5 NYLOCK NUT GR8.8 CZINC (2) 605831 M18-2.5 X 139.3 OAL OEM FORD BOLT (2) 605832 M18 FLAT WASHER GR 10.9 YZINC
TOOLS REQUIRED	
JACK JACK STANDS TORQUE WRENCH 8MM SOCKET / WRENCH 10MM SOCKET / WRENCH 13MM SOCKET / WRENCH 15MM SOCKET / WRENCH 18MM SOCKET / WRENCH 19MM SOCKET / WRENCH	24MM SOCKET / WRENCH 27MM SOCKET / WRENCH 30MM SOCKET / WRENCH 3/8" 12PT SOCKET / WRENCH 1/2" SOCKET / WRENCH 15/16" SOCKET / WRENCH 1 1/16" SOCKET / WRENCH 1 1/8" SOCKET / WRENCH
TECH NOTES	
N/A	



WARNING!
<p>** READ ALL INSTRUCTIONS THOROUGHLY FROM START TO FINISH BEFORE BEGINNING INSTALLATION! IF THESE INSTRUCTIONS ARE NOT PROPERLY FOLLOWED SEVERE FRAME, SUSPENSION AND TIRE DAMAGE MAY RESULT TO THE VEHICLE!</p> <p>** ICON VEHICLE DYNAMICS RECOMMENDS THAT YOU EXERCISE EXTREME CAUTION WHEN WORKING UNDER A VEHICLE THAT IS SUPPORTED WITH JACK STANDS.</p> <p>** ICON VEHICLE DYNAMICS RECOMMENDS ALL INSTALLTION TO BE PERFORMED BY A PROFESSIONAL SHOP/SERVICE TECHNICIAN. PRODUCT FAILURE CAUSED BY IMPROPER INSTALLATION WILL NOT BE COVERED UNDER ICON'S WARRANTY POLICY.</p>

INSTALLATION

1. Using a properly rated jack, raise the front end of the vehicle and support the frame rails with jack stands. The best positions to support the front of the truck are either the frame rails just behind the front bumper or on the body mounts just behind the front fenders. If lifting from the body mounts, be careful not to pinch the parking brake line on the driver's side. NEVER WORK UNDER AN UNSUPPORTED VEHICLE. Remove the front wheels.

2. Remove the sway bar links from the sway bar using an 18mm & 8mm. Leave them connected at the axle end. [FIGURE 1]

FIG.1

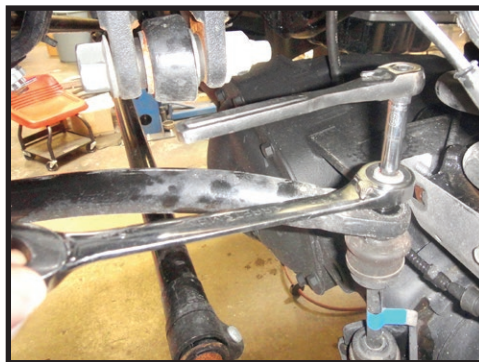

FIG.2



3. Disconnect the upper brake line brackets from the frame using a 13mm and lower brake line brackets from the axle using a 10mm. [FIGURE 2]

4. Remove the factory track bar using a 27mm and 30mm. (Refer to track bar #64038 instructions) [FIGURE 3]

FIG.3



5. Support the axle using a jack and remove the front shocks. The shocks are limiting droop so make sure that the axle is well supported or it will fall when the shocks are removed. Only remove the lower bolt using an 18mm.

6. Slowly lower the axle until the coils unload from the mounts. Be careful not to stretch or damage any lines connected to the differential or radius arms. Remove the coils. [FIGURE 4]

FIG.4



7. Some trucks have a transfer case skid plate that must be removed first using a 15mm. Remove the nut clips from the frame.

8. Lift the axle enough to reconnect the shocks and then lower the axle back down. [FIGURE 5]

FIG.5



FIG.6



9. With both coils removed, the radius arms don't have much force on them and can be safely removed from the frame mount using a 24mm & 27mm. [FIGURE 6]

10. Once the bolts are removed from the radius arms, lift up on the tie rod to rotate the axle rearward which will then rotate the radius arms out of their pockets. [FIGURE 7]

FIG.7



FIG.8



11. Remove the outside crossmember bolt on both sides. [FIGURE 8]

12. Position the driver side radius arm bracket into the radius arm pocket. Loosely install the supplied M18 X 139mm bolt with washers in the forward hole. Loosely install the supplied rear 3/4" X 5.5" bolt with washers into the radius arm holes. [FIGURE 9]



FIG.9

13. Spacers, washers, and a longer 12mm bolt are supplied to mount the radius arm bracket to the crossmember using a 19mm. The washers are used to account for the variances in crossmember placement in relation to the radius arm pockets. Position the supplied spacers and washers between the crossmember and radius arm bracket. One spacer must go on the driver and passenger (also front and rear) sides of the crossmember. Position the shims as needed. Four shims must be used on each side of the truck. The shim positioning may vary from one side to the other. [Torque to 65 ft-lbs] [FIGURE 10 & 11]



FIG.10



FIG.11

14. Next drill out the forward hole in the frame using a 7/16" drill bit. A step drill bit can be easier if available. Then install the supplied 7/16-14 hardware and torque to 50 ft-lbs [FIGURE 12].



FIG.12

15. With both of the frame brackets installed loosely on the vehicle, torque the M18 bolts/nuts to 250 ft-lbs.

16. Insert the supplied 5/8" bolt with washer and split washer inside the cross member and torque to 150 ft-lbs. [FIGURE 13]

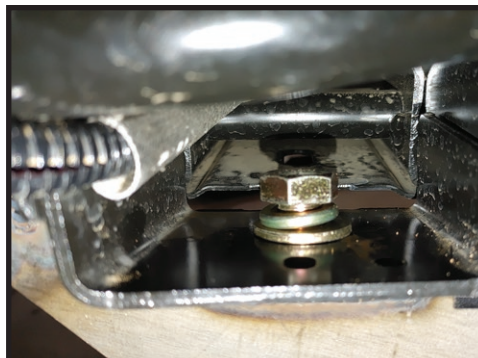
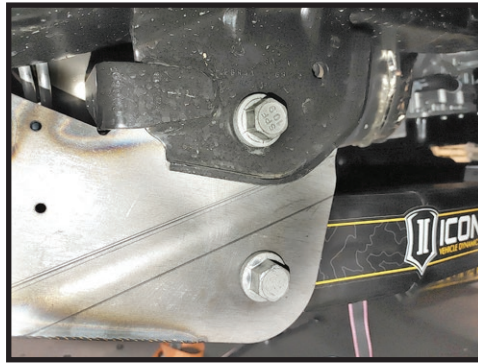

FIG.13

17. Move the radius arms up into the pockets of the drop bracket and fasten with the factory bolt using a 24mm & 27mm. [Torque to factory spec] [FIGURE 14]

FIG.14



18. Remove the shocks and lower the axle enough to install the coil springs.

19. Once the coils are in seated, install the shocks using an 18mm and 19mm. Be careful not to lift the truck off of its supports. [Torque to factory spec] [FIGURE 15]

FIG.15



FIG.16

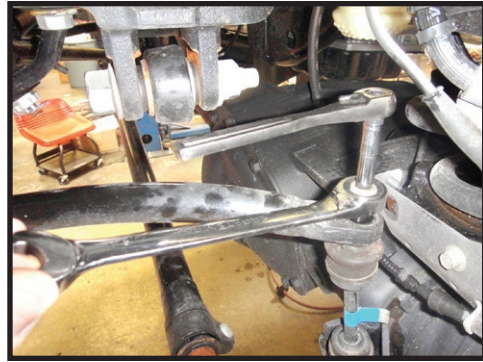

20. Reconnect the sway bar links to the sway bar using an 8mm and 18mm. [Torque to factory spec] [FIGURE 16]

21. Install the ICON adjustable track bar (64038) using a 30mm. (Refer to track bar instructions) [FIGURE 17]

FIG.17



22. Install the extended brake line kit (61110) available from ICON.

23. Mount the lower brake line brackets using the factory bolt and a 10mm. [Torque to factory spec] [FIGURE 18]

FIG.18



24. Install the wheels/tires and lower the vehicle to the ground. [Torque lugs to factory spec]
25. Center the front axle under the truck using the adjustable track bar. Center the steering wheel. Refer to track bar instructions.
26. Have the vehicle professionally aligned.

VERIFY ALL FASTENERS ARE PROPERLY TORQUED BEFORE DRIVING VEHICLE.

RETORQUE ALL NUTS, BOLTS AND LUGS AFTER 100 MILES AND PERIODICALLY THEREAFTER.

ICON VEHICLE DYNAMICS LIMITED LIFETIME WARRANTY

ICON Vehicle Dynamics warrants to the original retail purchaser who owns the vehicle on which the product was originally installed. ICON Vehicle Dynamics does not warrant the product for finish, alterations, modifications and/or installation contrary to ICON Vehicle Dynamics instructions. ICON Vehicle Dynamics products are not designed, nor are they intended to be installed on vehicles used in race applications, for racing purposes or for similar activities. (A "race" is defined as any contest between two or more vehicles, or a contest of one or more vehicles against the clock, whether or not such contest is for a prize). This warranty does not include coverage for police or taxi vehicles, race vehicles, or vehicles used for government or commercial purposes. Also excluded from this warranty are sales outside of the United States of America and Canada.

ICON Vehicle Dynamics' obligation under this warranty is limited to the repair or replacement, at ICON Vehicle Dynamics' discretion, of the defective product. Any and all costs of removal, installation or re-installation, freight charges and incidental or consequential damages are expressly excluded from this warranty. Items that are subject to wear are not considered defective when worn and are not covered.

ICON Vehicle Dynamics components must be installed as a complete kit as shown in our current application guide. Any substitutions or exemptions of required components will immediately void the warranty. Some finish damage may happen to parts during shipping and is not covered under warranty.

This warranty is expressly in lieu of all other warranties expressed or implied. This warranty shall not apply to any product that has been improperly installed, modified or customized subject to accident, negligence, abuse or misuse.

ICON VEHICLE DYNAMICS

PERFORMANCE SUSPENSION SYSTEMS AND SHOCK ABSORBERS

7929 Lincoln Ave. Riverside, CA 92504 Phone: 951.689.ICON Fax: 951.689.1016
www.iconvehicledynamics.com



FOLLOW US ON FACEBOOK!



7929 Lincoln Ave. Riverside, CA 92504
 Phone: 951.689.ICON | Fax: 951.689.1016

PART #	DESCRIPTION
65053	23 FSD 2.5 CENTERLINE STABILIZER KIT

COMPONENTS INCLUDED	
(1) 164053 23 FSD THRU SHAFT SS, DIFF BRACKET	(1) 164952 05-UP FSD 4WD STAB 2.5 PB UPKG
HARDWARE INCLUDED	
(4) 605056 1/4-20 X 1.750 SHCS 18-8 (4) M8-1.25 X 40MM FLANGE BOLT BPHOS (1) 605306 1/2-13 X 2.500 HHCS	(1) 605330 1/2 SAE FLAT WASHER (1) 605333 1/2-13 FLANGED NYLOCK NUT (1) 297206 44MM BILLET TUBE CLAMP FRONT
TOOLS REQUIRED	
TORQUE WRENCH TAPE MEASURE 13MM SOCKET / WRENCH	3/16" ALLEN WRENCH 3/4" SOCKET / WRENCH
TECH NOTES	
<ol style="list-style-type: none"> 1. AFTER INSTALLATION, CYCLE STEERING LEFT AND RIGHT TO ENSURE FULL RANGE OF STEERING IS ACHIEVABLE AND STABILIZER IS INSTALLED CORRECTLY. 2. USE THE SUPPLIED 1" FRONT BUMP STOP SPACERS UNLESS THE SUSPENSION SYSTEM THAT YOU ARE USING CALLS FOR LARGER BUMP STOP SPACERS. IF USING A NON-ICON CONFIGURATION, CYCLE THE SUSPENSION TO VERIFY THAT THE STABILIZER DOES NOT MAKE CONTACT UPON FULL COMPRESSION. 3. MOUNTS OVER STOCK FRON DIFFERENTIAL COVER, NOT COMPATIBLE WITH MOST AFTERMARKET COVERS. 4. NOT COMPATIBLE WITH AFTERMARKET TIE RODS 5. ONLY COMPATIBLE WITH 4WD MODELS 	



WARNING!
<p>** READ ALL INSTRUCTIONS THOROUGHLY FROM START TO FINISH BEFORE BEGINNING INSTALLATION! IF THESE INSTRUCTIONS ARE NOT PROPERLY FOLLOWED SEVERE FRAME, SUSPENSION AND TIRE DAMAGE MAY RESULT TO THE VEHICLE!</p> <p>** ICON VEHICLE DYNAMICS RECOMMENDS THAT YOU EXERCISE EXTREME CAUTION WHEN WORKING UNDER A VEHICLE THAT IS SUPPORTED WITH JACK STANDS.</p> <p>** ICON VEHICLE DYNAMICS RECOMMENDS ALL INSTALLATION TO BE PERFORMED BY A PROFESSIONAL SHOP/SERVICE TECHNICIAN. PRODUCT FAILURE CAUSED BY IMPROPER INSTALLATION WILL NOT BE COVERED UNDER ICON'S WARRANTY POLICY.</p>

INSTALLATION

1. Remove the (4) highlighted bolts from the differential cover using a 13MM socket/wrench. [FIGURE 1]

FIG.1

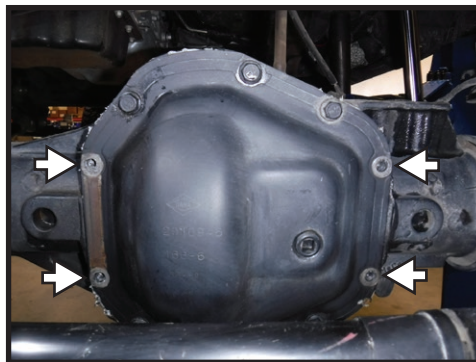

2. Install the steering stabilizer bracket over the differential cover using the supplied M8-1.25 bolts. Tighten using a 13MM socket/wrench. [Torque to factory spec] [FIGURE 2]

FIG.2

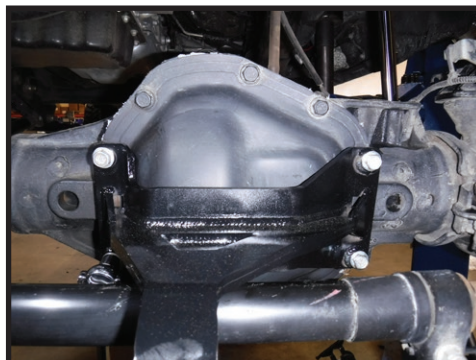

3. Set the steering stabilizer so there is 4.340" of dead shaft showing. [FIGURE 3]

FIG.3



4. Install the steering stabilizer with the rod end side into the bracket using the supplied 1/2" hardware and a 3/4" socket/wrench. [Torque to 80 ft-lbs] [FIGURE 4]

FIG.4



5. Install stabilizer clamp onto the tie rod, being sure not to extend or collapse the stabilizer. Make sure steering wheel and tires are straight/centered. Use the (4) supplied 1/4-20 allen bolts to tighten the tube clamp using a 3/16" allen wrench. Being sure to tighten it evenly. Keep stabilizer parallel with tie rod while tightening [Torque to 8 ft-lbs]. Be sure the reservoir is position at 45°. [FIGURE 5]

FIG.5



6. After installation, cycle steering left and right to ensure full range of steering is achievable and stabilizer is installed correctly.



VERIFY ALL FASTENERS ARE PROPERLY TORQUED BEFORE DRIVING VEHICLE.

RETORQUE ALL NUTS, BOLTS AND LUGS AFTER 100 MILES AND PERIODICALLY THEREAFTER.

ICON VEHICLE DYNAMICS LIMITED LIFETIME WARRANTY

ICON Vehicle Dynamics warrants to the original retail purchaser who owns the vehicle on which the product was originally installed. ICON Vehicle Dynamics does not warrant the product for finish, alterations, modifications and/or installation contrary to ICON Vehicle Dynamics instructions. ICON Vehicle Dynamics products are not designed, nor are they intended to be installed on vehicles used in race applications, for racing purposes or for similar activities. (A "race" is defined as any contest between two or more vehicles, or a contest of one or more vehicles against the clock, whether or not such contest is for a prize). This warranty does not include coverage for police or taxi vehicles, race vehicles, or vehicles used for government or commercial purposes. Also excluded from this warranty are sales outside of the United States of America and Canada.

ICON Vehicle Dynamics' obligation under this warranty is limited to the repair or replacement, at ICON Vehicle Dynamics' discretion, of the defective product. Any and all costs of removal, installation or re-installation, freight charges and incidental or consequential damages are expressly excluded from this warranty. Items that are subject to wear are not considered defective when worn and are not covered.

ICON Vehicle Dynamics components must be installed as a complete kit as shown in our current application guide. Any substitutions or exemptions of required components will immediately void the warranty. Some finish damage may happen to parts during shipping and is not covered under warranty.

This warranty is expressly in lieu of all other warranties expressed or implied. This warranty shall not apply to any product that has been improperly installed, modified or customized subject to accident, negligence, abuse or misuse.



ICON VEHICLE DYNAMICS®
PERFORMANCE SUSPENSION SYSTEMS AND SHOCK ABSORBERS

7929 Lincoln Ave. Riverside, CA 92504 Phone: 951.689.ICON Fax: 951.689.1016
www.iconvehicledynamics.com



FOLLOW US ON FACEBOOK!



7929 Lincoln Ave. Riverside, CA 92504
Phone: 951.689.ICON | Fax: 951.689.1016

PART #	DESCRIPTION
67811CP	23 FSD 4WD 4.5" FRONT 2.5 VS RR CDCV PAIR

COMPONENTS INCLUDED	
(2) 164953C-AL 23 FSD 4.5" FRONT AL RR CDCV (2) 160085 05-UP FSD RESI MT COIL BUCKET	(2) 611006 9/16" HD STEM BUSHING KIT (1) 611051 #40 2 1/16-3" HOSE CLAMP KIT
HARDWARE INCLUDED	
N/A	
611006 HARDWARE KIT	
(2) HEAVY DUTY 9/16 ID STEM BUSHING (1) HEAVY DUTY 9/16 ID STEM WASHER (1) HEAVY DUTY 12MM ID STEM WASHER	(1) M12-1.25 NUT (1) M12-1.25 JAM NUT
611051 HARDWARE KIT	
(4) 605931 1/2 X 2 1/16-3 ID #40 SS HOSE CLAMP	
TOOLS REQUIRED	
JACK JACK STANDS PLIERS DRILL 11/32" DRILL BIT TORQUE WRENCH	5/16" SOCKET / WRENCH 9/16" SOCKET / WRENCH 17MM SOCKET / WRENCH 18MM SOCKET / WRENCH 19MM SOCKET / WRENCH
TECH NOTES	
1. YOUR ICON SHOCK ASSEMBLIES COME FACTORY CHARGED TO 250 PSI. RELEASING NITROGEN PRESSURE MAY LEAD TO SHOCK MALFUNCTION AND REDUCED RIDE QUALITY. FAILURE CAUSED BY LOW NITROGEN PRESSURE IS NOT COVERED UNDER ICON'S WARRANTY POLICY.	
2. ESTIMATED INSTALL TIME: 3-4 HOURS	



WARNING!

**** READ ALL INSTRUCTIONS THOROUGHLY FROM START TO FINISH BEFORE BEGINNING INSTALLATION! IF THESE INSTRUCTIONS ARE NOT PROPERLY FOLLOWED SEVERE FRAME, SUSPENSION AND TIRE DAMAGE MAY RESULT TO THE VEHICLE!**

**** ICON VEHICLE DYNAMICS RECOMMENDS THAT YOU EXERCISE EXTREME CAUTION WHEN WORKING UNDER A VEHICLE THAT IS SUPPORTED WITH JACK STANDS.**

**** ICON VEHICLE DYNAMICS RECOMMENDS ALL INSTALLATION TO BE PERFORMED BY A PROFESSIONAL SHOP/SERVICE TECHNICIAN. PRODUCT FAILURE CAUSED BY IMPROPER INSTALLATION WILL NOT BE COVERED UNDER ICON'S WARRANTY POLICY.**

INSTALLATION

- Using a properly rated jack, raise the front of the vehicle and support the frame rails with jack stands. Ensure the jack stands are secure and set properly before lowering the jack. NEVER WORK UNDER AN UNSUPPORTED VEHICLE. Remove the front wheels.
- Use a jack to support the axle and then remove the factory shock using a 17mm and 18mm socket/wrench.
- Remove the sway bar links from the sway bar using an 18mm socket/wrench. Leave them connected to the differential. [FIGURE 1]

FIG.1

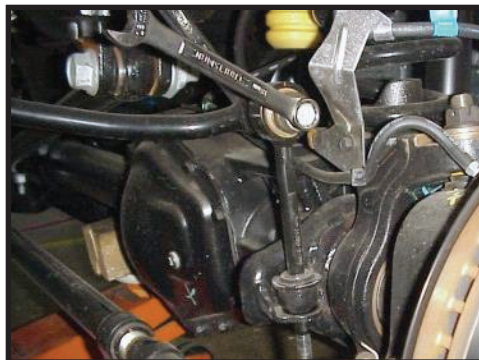

FIG.2



- Disconnect the upper brake line brackets from the frame using a 13mm socket/wrench and lower brake line brackets from the differential using a 10mm socket/wrench. [FIGURE 2]

5. On the driver side of the track bar, remove the nut and the upper track bar bolt using (2) 30mm socket/wrenches. [FIGURE 3]

FIG.3

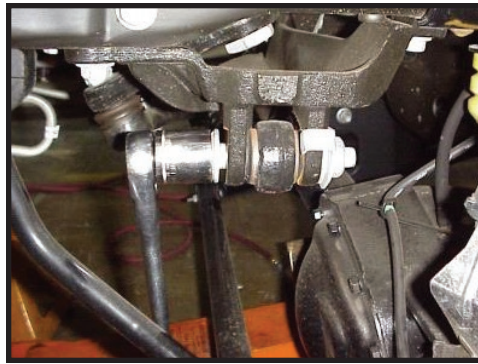

6. Slowly lower the axle, the coils will unload from the mounts and can be removed. Be careful not to stretch or damage any lines connected to the axle or radius arms.

7. Lower the axle enough to install the reservoir mount (PN 160085) between the coil bucket and the coil isolator.

8. Raise the axle using a floor jack

9. Install stem hardware as seen in diagram. Install (605810) tall nut and fasten bushing assembly until 3-4 threads are exposed for the (605809) jam nut. Install (605809) nut and torque to 50 ft-lbs while holding (605810) with a 19mm wrench. Do not overtighten bushing assembly as this can lead to premature bushing wear. Failure caused by incorrect installation of bushings is not covered under ICON's warranty policy. Install the wide heim spacer so that it orients the shock further away from the frame and then install the factory lower bolt using an 18mm socket/wrench. [Torque to factory spec] [SEE DIAGRAM]

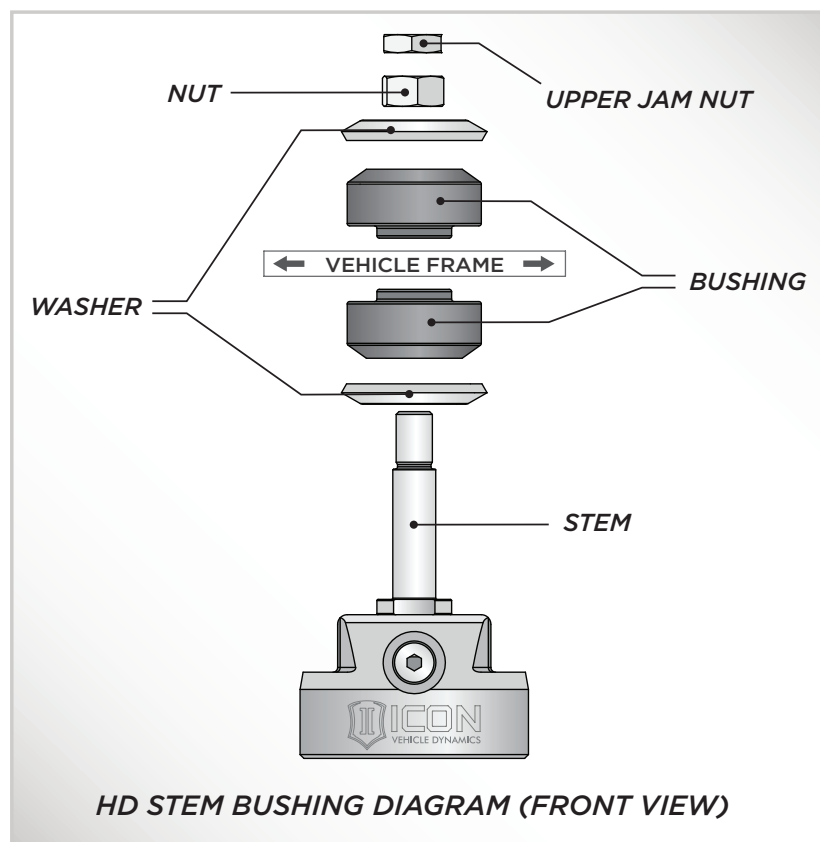

10. If installing coilover conversion, use the doubler reservoir mount (supplied in coilover kit) for mounting both reservoirs as shown. (photos show CDEV, CDCV will be the same mounting. [FIGURE 4]

FIG.4



11. Mount the reservoir to the bracket using a 5/16" nut driver and the supplied (605931) hose clamps. [FIGURE 5]

FIG.5



12. Connect the sway bar links to the sway bar using an 18mm socket/wrench. [Torque to factory spec]

13. Reconnect the upper brake line bracket to the frame using a 13mm socket/wrench and the lower bracket using a 10mm socket/wrench [Torque to factory spec]. Depending on the year of the truck, the brake line may need to be manipulated down to not overextend at full droop.

14. Reconnect the track bar using (2) 30mm socket/wrenches. [Torque to factory spec]

15. Install wheels and lower vehicle to the ground. [Torque lugs to factory spec]

16. Have the vehicle professionally aligned.

VERIFY ALL FASTENERS ARE PROPERLY TORQUED BEFORE DRIVING VEHICLE.

RETORQUE ALL NUTS, BOLTS AND LUGS AFTER 100 MILES AND PERIODICALLY THEREAFTER.

2.5 VS SERIES SHOCK & COILOVER TECHNICAL INFORMATION

MAINTENANCE

ICON shock absorbers are a high quality rebuildable race style shock absorber designed for optimal performance. With a unit of this caliber on your vehicle, routine maintenance is required to keep them looking and operating in like new condition. Residual oil and assembly lube may be present at all seal paths from the factory out of the box and is considered normal. Pooling of oil however is not acceptable at any time and one should contact the ICON dealer where purchased.

BELOW ARE GUIDELINES BASED ON HOW YOU USE YOUR VEHICLE BUT YOUR MILEAGE MAY VARY:

STREET USE:

- Send in for factory servicing every 40,000 miles or if a leak develops, ride quality decreases, or they begin to make excessive noise.
- Remove any buildup of road salt, mud, or debris from shocks and coil springs anytime accrued
- Clean with mild soap and water with each oil change or anytime you notice build up.
- Wax the cylinders yearly with automotive wax to prevent corrosion.
- Check nitrogen pressure yearly. (252004 charge needle assembly available at any ICON distributor)
- Check bearings for excessive wear yearly.
- DO NOT apply any type of lube to the upper and lower bearings.

STREET/DIRT:

- Send in for factory servicing every 15,000 miles or if a leak develops, ride quality decreases, or they begin to make excessive noise.
- Clean with mild soap and water with each oil change, offroad trip, or anytime you notice build up.
- Wax the cylinders yearly with automotive wax to prevent corrosion.
- Check nitrogen pressure each dirt outing. (252004 charge needle assembly available at any ICON distributor)
- Check bearings for excessive wear yearly.
- DO NOT apply any type of lube to the upper and lower bearings.

DIRT USE:

- Send in for factory servicing every 1,000 miles.
- Check nitrogen pressure each outing. (252004 charge needle assembly available at any ICON distributor)
- Remove any buildup of mud or debris from shocks and coil springs after every outing.

SELF-SERVICE:

- Contact ICON for service kits & tools at (951) 689-4266.

PRODUCT REGISTRATION

Please visit: <http://www.iconvehicledynamics.com/tech-support/registration/> to register your product.

ICON VEHICLE DYNAMICS SHOCK ABSORBER WARRANTY

This shock absorber has a 1 year warranty against any manufacturer's defects. If a shock fails within the initial year of ownership, the shock must be shipped to ICON Vehicle Dynamics for inspection and service. If a shock is inspected and it has been determined the shock failed due to neglect, damage caused by improper installation or any other reason besides "normal wear and tear", the owner of said shock is responsible for all service costs. This includes labor, parts, and shipping.

ICON Vehicle Dynamics warrants to the original retail purchaser who owns the vehicle on which the product was originally installed. ICON Vehicle Dynamics does not warrant the product for finish, alterations, modifications and/or installation contrary to ICON Vehicle Dynamics instructions. ICON Vehicle Dynamics products are not designed, nor are they intended to be installed on vehicles used in race applications, for racing purposes or for similar activities. (A "race" is defined as any contest between two or more vehicles, or a contest of one or more vehicles against the clock, whether or not such contest is for a prize). This warranty does not include coverage for police or taxi vehicles, race vehicles, or vehicles used for government or commercial purposes. Also excluded from this warranty are sales outside of the United States of America and Canada.

ICON Vehicle Dynamics' obligation under this warranty is limited to the repair or replacement, at ICON Vehicle Dynamics' discretion, of the defective product. Any and all costs of removal, installation or re-installation, freight charges and incidental or consequential damages are expressly excluded from this warranty. Items that are subject to wear are not considered defective when worn and are not covered.

ICON Vehicle Dynamics components must be installed as a complete kit as shown in our current application guide. Any substitutions or exemptions of required components will immediately void the warranty. Some finish damage may happen to parts during shipping and is not covered under warranty.

This warranty is expressly in lieu of all other warranties expressed or implied. This warranty shall not apply to any product that has been improperly installed, modified or customized subject to accident, negligence, abuse or misuse.

To send a shock in for warranty please visit our website <http://www.iconvehicledynamics.com/tech-support/shock-service/>



ICON VEHICLE DYNAMICS®
PERFORMANCE SUSPENSION SYSTEMS AND SHOCK ABSORBERS

7929 Lincoln Ave. Riverside, CA 92504 Phone: 951.689.ICON Fax: 951.689.1016
www.iconvehicledynamics.com



FOLLOW US ON FACEBOOK!



7929 Lincoln Ave. Riverside, CA 92504
Phone: 951.689.ICON | Fax: 951.689.1016

PART #	DESCRIPTION
168507	08-UP FSD EXPANSION PACK

COMPONENTS INCLUDED	
(2) 168507 08-UP FSD EXPANSION PACK	
HARDWARE INCLUDED	
(2) 7/16 X 5/8 X 3/8 X 6" CENTER PIN (2) 7/16 CENTER PIN NUT (4) 3/8 X 4 CLIP BOLT	(4) 3/8 CLIP NUT (4) 3/8 CLIP SPACER
TOOLS REQUIRED	
FLOOR JACK JACK STANDS TORQUE WRENCH C-CLAMP VISE-GRIP 15MM SOCKET/WRENCH	18MM SOCKET/WRENCH 21MM SOCKET/WRENCH 5/8" SOCKET/WRENCH 9/16" SOCKET/WRENCH 15/16" SOCKET/WRENCH
TECH NOTES	
<p>1. DEPENDING ON YEAR AND BLOCK CONFIGURATION INSTALLER MUST USE THE APPROPRIATE U-BOLTS.</p> <p>2. SINGLE REAR WHEEL ONLY.</p> <p>3. ESTIMATED INSTALL TIME: 2-3 HOURS</p>	



WARNING!
<p>** READ ALL INSTRUCTIONS THOROUGHLY FROM START TO FINISH BEFORE BEGINNING INSTALLATION! IF THESE INSTRUCTIONS ARE NOT PROPERLY FOLLOWED SEVERE FRAME, SUSPENSION AND TIRE DAMAGE MAY RESULT TO THE VEHICLE!</p> <p>** ICON VEHICLE DYNAMICS RECOMMENDS THAT YOU EXERCISE EXTREME CAUTION WHEN WORKING UNDER A VEHICLE THAT IS SUPPORTED WITH JACK STANDS.</p> <p>** ICON VEHICLE DYNAMICS RECOMMENDS ALL INSTALLATION TO BE PERFORMED BY A PROFESSIONAL SHOP/SERVICE TECHNICIAN. PRODUCT FAILURE CAUSED BY IMPROPER INSTALLATION WILL NOT BE COVERED UNDER ICON'S WARRANTY POLICY.</p>

INSTALLATION

1. Lift the back of the truck. Support the frame at the frame rail with jack stands. NEVER WORK UNDER AN UNSUPPORTED VEHICLE. Remove rear tires. Support the rear axle with a jack, as you will need to raise and lower it.
2. Remove both rear shocks from the mounts using an 18mm and 21mm. [FIGURE 1 & 2]

FIG.1



FIG.2



3. Depending on model, Using a pry bar, open the U-clips towards the ends of the spring pack that help to hold the leaves in-line with each other. On other models, you will need to loosen and remove the bolt on the underside that holds the clip in place. Remove the clip and discard. [FIGURE 3]

FIG.3



4. Loosen and remove the U-bolts using a 15/16". Doing one leaf pack at a time is easiest and prevents the axle from 'tipping' forward.

5. Loosen the center pin nut using a 15mm.

6. Slowly lower the axle until the leaf springs and center pin are from the axle and factory lift block. DO NOT ALLOW THE AXLE TO HANG FROM ANY HOSES OR WIRES.

7. Now all but the main leaf can be removed from the vehicle (F-350 and F-250 with Tremor or 'High Cap Tow' can keep the top helper spring and spacer). They can be reinstalled at the end if desired.

8. Remove the 3/8" bolts/nuts and crush sleeve from the add-a-leaf U-clips, set aside for later.

9. Carefully remove the center pin nut from the add-a-leaf and place the pack under the main leaf that is still in the truck. Be sure to take the top slider from the factory leaf pack and place it between the add-a-leaf and main leaf (You may need to loosen the opposite side U-bolts to allow the axle to droop out enough).

10. Align all the leaves together using the center pin, thread the nut onto the pin. Install the lift block (if applicable) between the springs and axle and begin to jack up the axle to compress the leaf pack together so the center pin and nut can be tightened. Torque to 50 ft-lbs.

11. Make sure the center pin is in the axle perch or if a lift block is being used, be sure the lift block pin is in the perch correctly and the leaf spring center pin is in the lift block correctly. Install the U-bolt plate and U-bolts in the same way as factory, Tighten by hand ensuring they are evenly tightened. If truck had a helper spring and spacer, reinstall that now if desired. [Torque to 110 ft-lbs] [FIGURE 5 & 6]

FIG.4



FIG.5



12. Reinstall the 3/8" hardware and spacers into the u-clips towards the ends of the springs. [FIGURE 6 & 7]

FIG.6



FIG.7



13. Repeat installation on opposite side.

14. Reinstall shocks.

15. Retorque U-bolts in 1000 Miles.

VERIFY ALL FASTENERS ARE PROPERLY TORQUED BEFORE DRIVING VEHICLE.

RETORQUE ALL NUTS, BOLTS AND LUGS AFTER 100 MILES AND PERIODICALLY THEREAFTER.

ICON VEHICLE DYNAMICS LIMITED LIFETIME WARRANTY

ICON Vehicle Dynamics warrants to the original retail purchaser who owns the vehicle on which the product was originally installed. ICON Vehicle Dynamics does not warrant the product for finish, alterations, modifications and/or installation contrary to ICON Vehicle Dynamics instructions. ICON Vehicle Dynamics products are not designed, nor are they intended to be installed on vehicles used in race applications, for racing purposes or for similar activities. (A "race" is defined as any contest between two or more vehicles, or a contest of one or more vehicles against the clock, whether or not such contest is for a prize). This warranty does not include coverage for police or taxi vehicles, race vehicles, or vehicles used for government or commercial purposes. Also excluded from this warranty are sales outside of the United States of America and Canada.

ICON Vehicle Dynamics' obligation under this warranty is limited to the repair or replacement, at ICON Vehicle Dynamics' discretion, of the defective product. Any and all costs of removal, installation or re-installation, freight charges and incidental or consequential damages are expressly excluded from this warranty. Items that are subject to wear are not considered defective when worn and are not covered.

ICON Vehicle Dynamics components must be installed as a complete kit as shown in our current application guide. Any substitutions or exemptions of required components will immediately void the warranty. Some finish damage may happen to parts during shipping and is not covered under warranty.

This warranty is expressly in lieu of all other warranties expressed or implied. This warranty shall not apply to any product that has been improperly installed, modified or customized subject to accident, negligence, abuse or misuse.



ICON VEHICLE DYNAMICS®
PERFORMANCE SUSPENSION SYSTEMS AND SHOCK ABSORBERS

7929 Lincoln Ave. Riverside, CA 92504 Phone: 951.689.ICON Fax: 951.689.1016
www.iconvehicledynamics.com



FOLLOW US ON FACEBOOK!

