

4. Place the side rail on the bed rail, and push it to the front wall of truck bed. Place one clamp at the front of the side rail and one at the rear (please make sure the rear clamps is placed on the position that is closest to tailgate). Tighten the clamps each side.

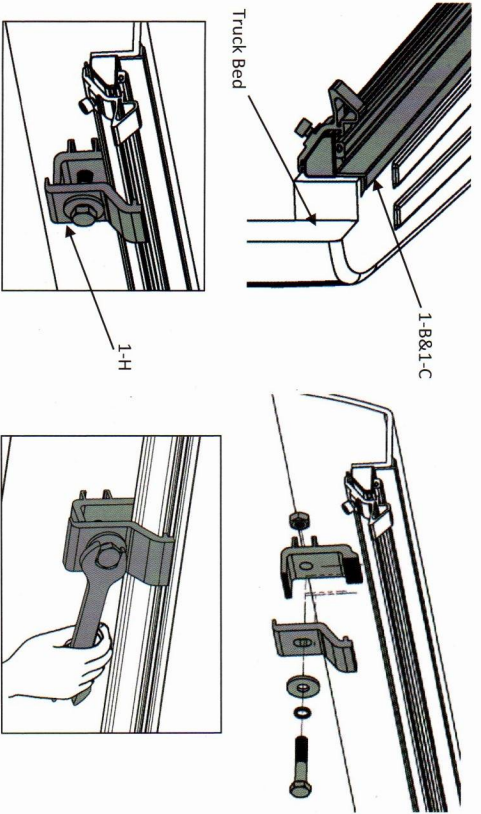

5. If the truck bed side rails are higher than the front edge of the bed, stick the foam seal tape on the front edge of the bed.

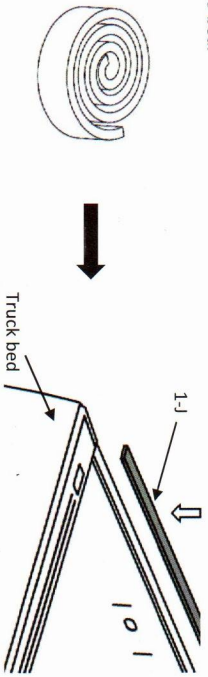

6. Place the tonneau cover over on the front end of truck bed. Ensure the cover is even on all sides and sit firmly on side rails.

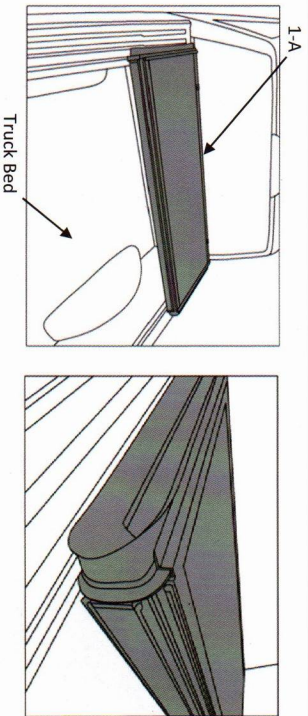

7. Adjust the front support plate(1-F) to correct position, insert the front bolt into the holes on the cover front panel and front support plate. Then tighten the plastic nut under the front support plate.

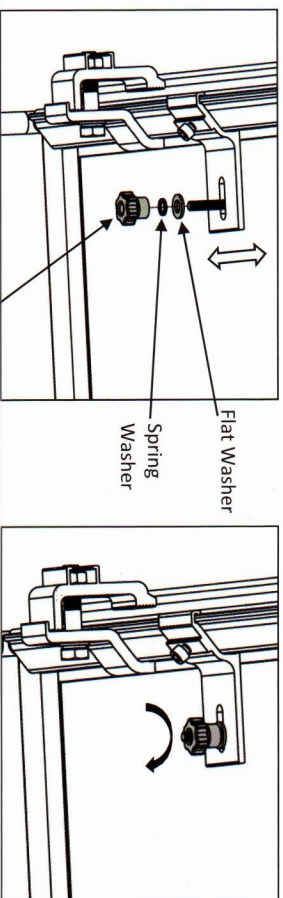
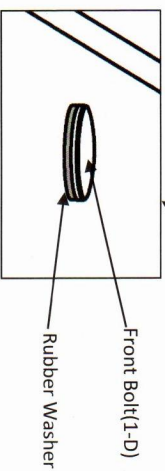
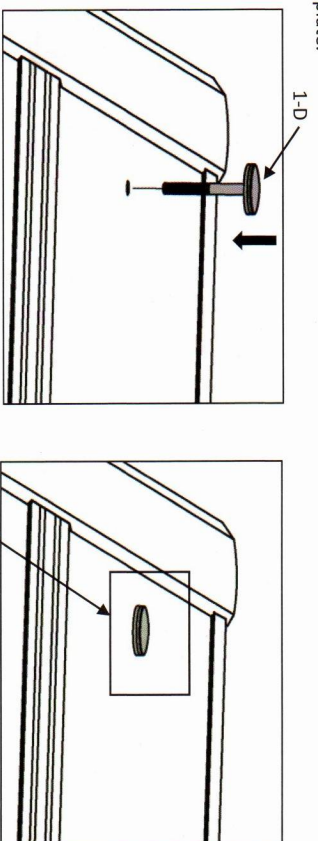

※ATTENTION: Make sure the Flat Washer and Spring Washer are all placed on bolt before screw the plastic nut on.

8. Unfold the cover, ensure the cover latch touch the side rail locking tongues(1-G). If necessary, adjust the Locking Tongue(1-G) to match the Latch position. Tighten the side rail locking tongues. Lock the cover and close the tailgate.

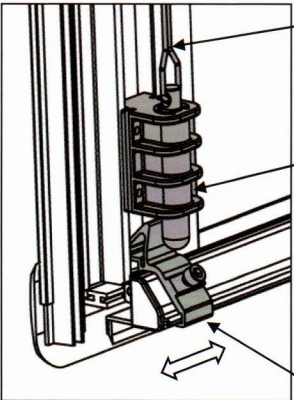
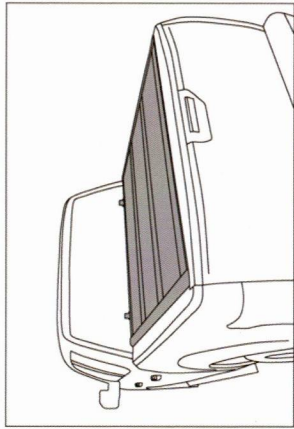
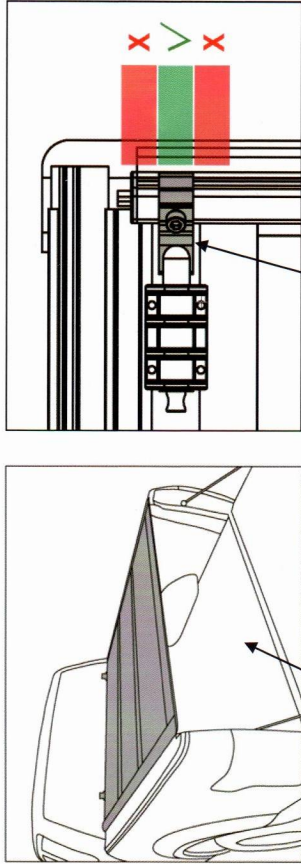

BE ATTENTION: TIGHTEN ALL BOLTS & NUTS BEFORE DRIVING!

STEPS:

1. Check Contents of carton with the list above.
2. 2-1 Slide the Front Support Plate (1-F) into the side rails, and move the Front Support Plate (1-F) to front of side rail.

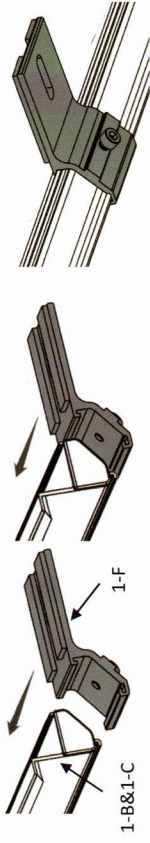

- 2-2 Slide the Side Rail Locking Tongue (1-G) into side rail and move it to the rear of side rail. Do not tighten the bolts.



- 2-3 Insert the drain tubes(1-E) into the front of side rails.

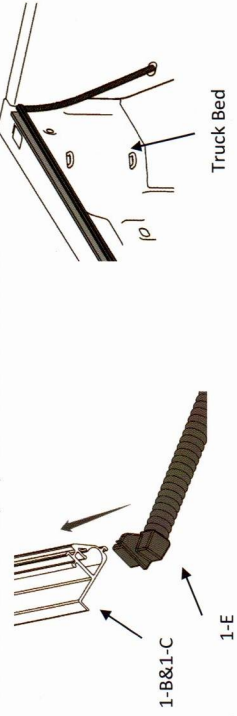

3. Cut the Rubber strip into six (or more) pieces. Some truck bed edges are not flat, so you need to stick the rubber strips on the side rail's upper or lower edges.

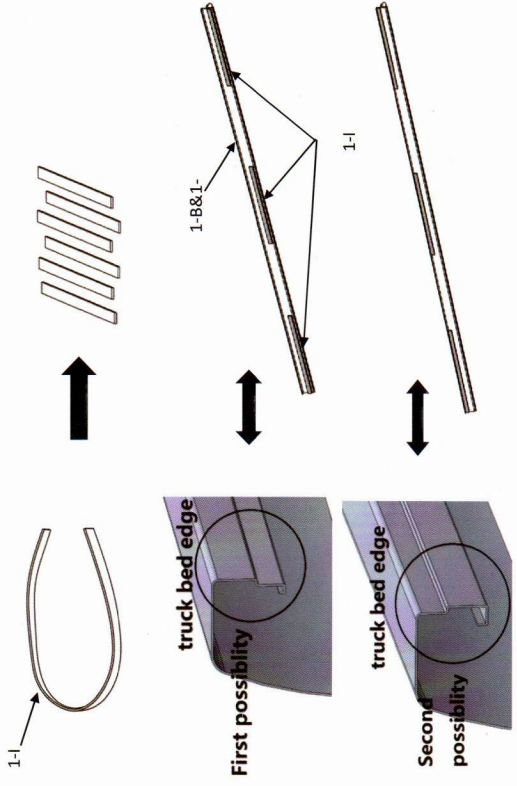

When you open the tonneau cover box you will see the accessories:

Item	Description	Qty	Picture
1-A	Tonneau Cover	1	
1-B	Left Side Rail	1	
1-C	Right Side Rail	1	
1-D	Front Bolt	2	
1-E	Drain Tube	2	
1-F	Front Support Plate (Including Bolts)	2	
1-G	Side Rail Locking Tongue (Including Bolts)	2	
1-H	Clamp Assembly (Clamps A)	4	
1-I	Rubber Strip	1	
1-J	Foam Seal Tape	1	

Accessories: Allen Wrench 1pc, #17 Wrench 1pc

Note: Clamp for Toyota Tundra Truck Bed with Utility Track System, please see page-8

Safety Buckles Instructions

When you open the cover, there are two safety buckles on each side of the cover front panel.

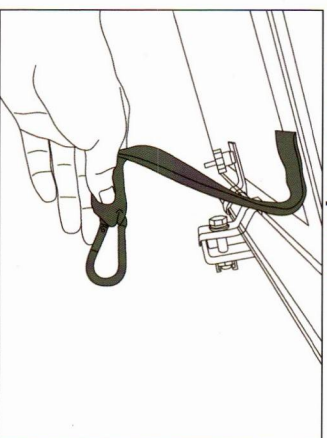

When installing the side rail, make sure one side rail clamp is installed nearby the Strap Safety Buckle position. There is a hole on the bottom of the clamp. Snap the safety buckle into the hole of the clamp. (*For truck with Utility Track System, need to hook the buckle on the side rail clamp bolt)

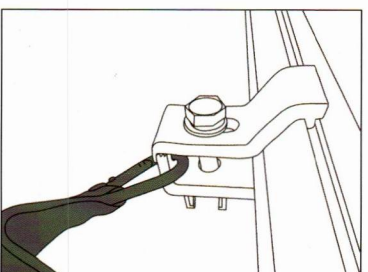
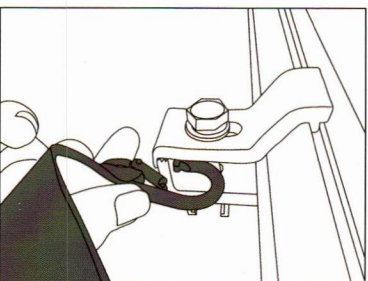

WARNING:

Always secure the safety straps to the truck bed. Never drive with a cover in partially opened position.

For Nissan/Toyota Trucks (with Utility Track System) only

When you open the box, you will see the below clamps.

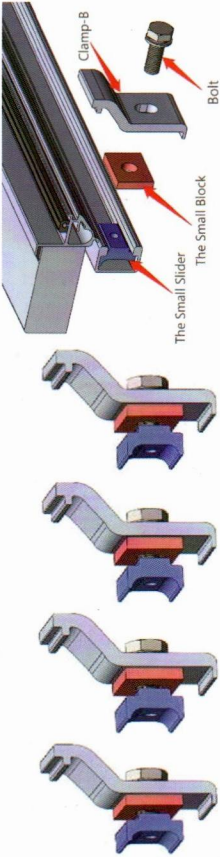

Step-1. Insert the small sliders into the Track Channels. Place one in the front of channel and the other one in the rear of the channel.

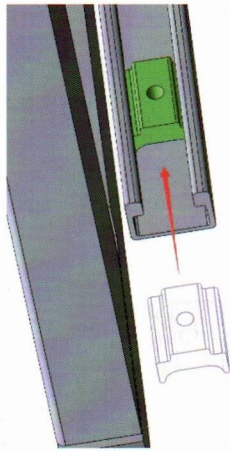

Step-2. Secure the side rail and truck bed with the clamps (Bolt the Clamp-B, the small Block and the Small Slider together). Place one clamp at the front of the side rail and one at the rear most point. Tighten the clamps each side. Then follow the main installation.

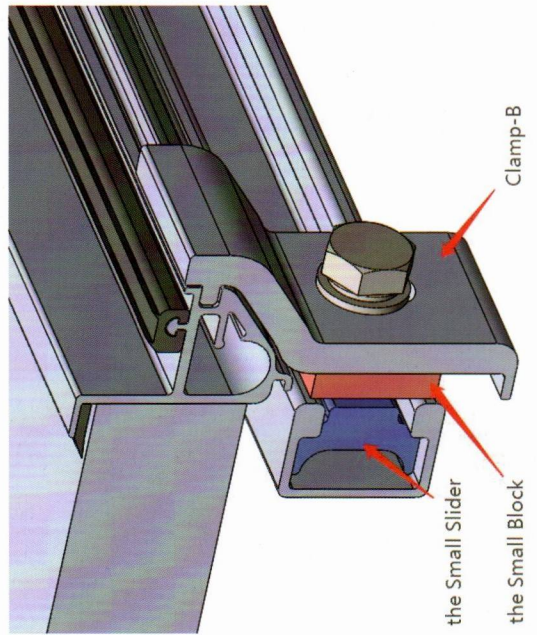

INSTALLATION MANUAL

Lightweight Low Profile Tri-Fold Hard Tonneau Cover

