



***DOWNLOAD COLOUR
INSTALL MANUALS AT
www.bddiesel.com***



68RFE Line Pressure Module

2007-2018 250PSI

1030369

2007-2018 220PSI

1030366



PLEASE READ ALL INSTRUCTIONS BEFORE INSTALLATION



KIT CONTENTS

Please check you have all the parts listed before you begin installation

Kit # **1030369** (2007-2018 6.7L 250psi 68RFE) contains:

Kit # **1030366** (2007-18 6.7L 220psi 68RFE) contains:

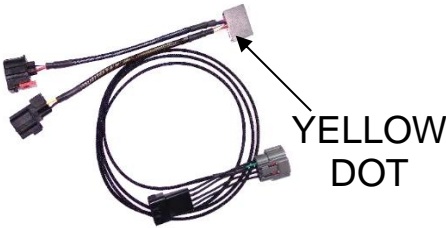
1600368	1300131
	
68RFE 250psi Pressure Module	Tie Wrap (6")
QTY: 1	QTY: 8

1600370	1300131
	
68RFE 220psi Pressure Module	Tie Wrap (6")
QTY: 1	QTY: 8

Line Pressure Module Operation

The BD 68RFE Line Pressure Module increases line pressure above stock levels to aid in holding applied transmission clutches and prevent clutch slipping. Stock line pressure varies between 60-160psi, with the **1600368** module installed the range becomes 60-250psi. With the **1600370** module installed the range becomes 60-220psi. At low load situations the module will not command any additional pressure, but as engine boost rises (and power output increases) the module will increase the line pressure to 250psi/220psi depending on the module.

Line Pressure Module installation

Connect the BD pressure module inline between the Line Pressure Sensor and the OEM harness. Secure the BD module to the OEM harness using the provided tie wraps. Route the MAP sensor wire over the transmission and to the back of the intake horn. Connect it in line with the factory MAP sensor. Secure the wiring harness with supplied tie wraps and keep away from moving parts like the steering shaft or front drive shaft. Ensure connections are fully mated and have clicked together.

Line pressure Sensor Connection

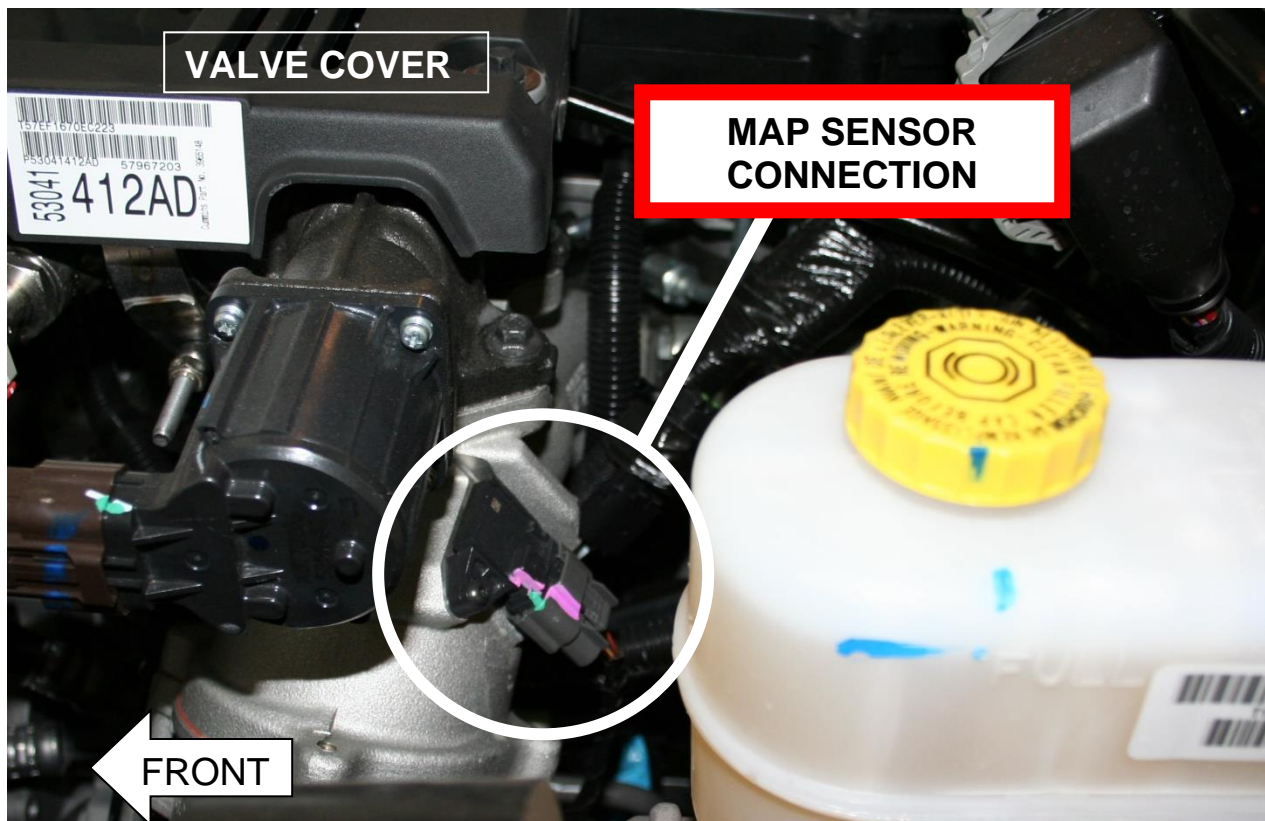
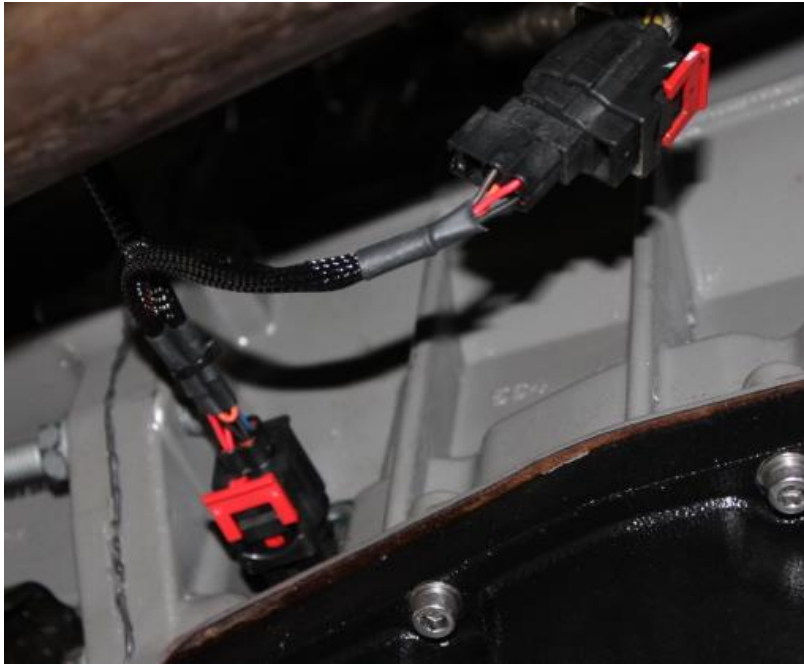

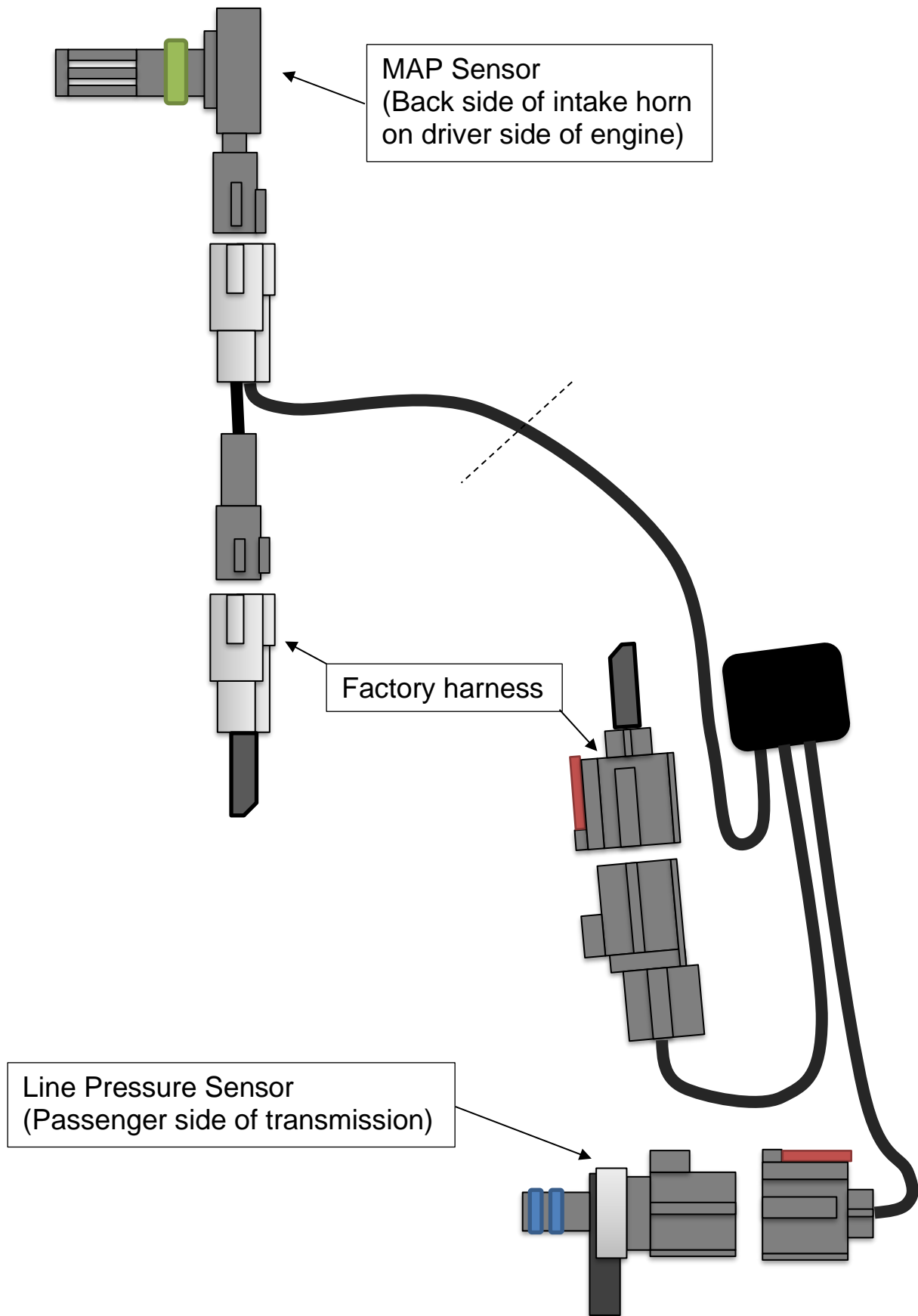



**DOWNLOAD THE LATEST
INSTALL MANUALS AT
www.bddiesel.com**

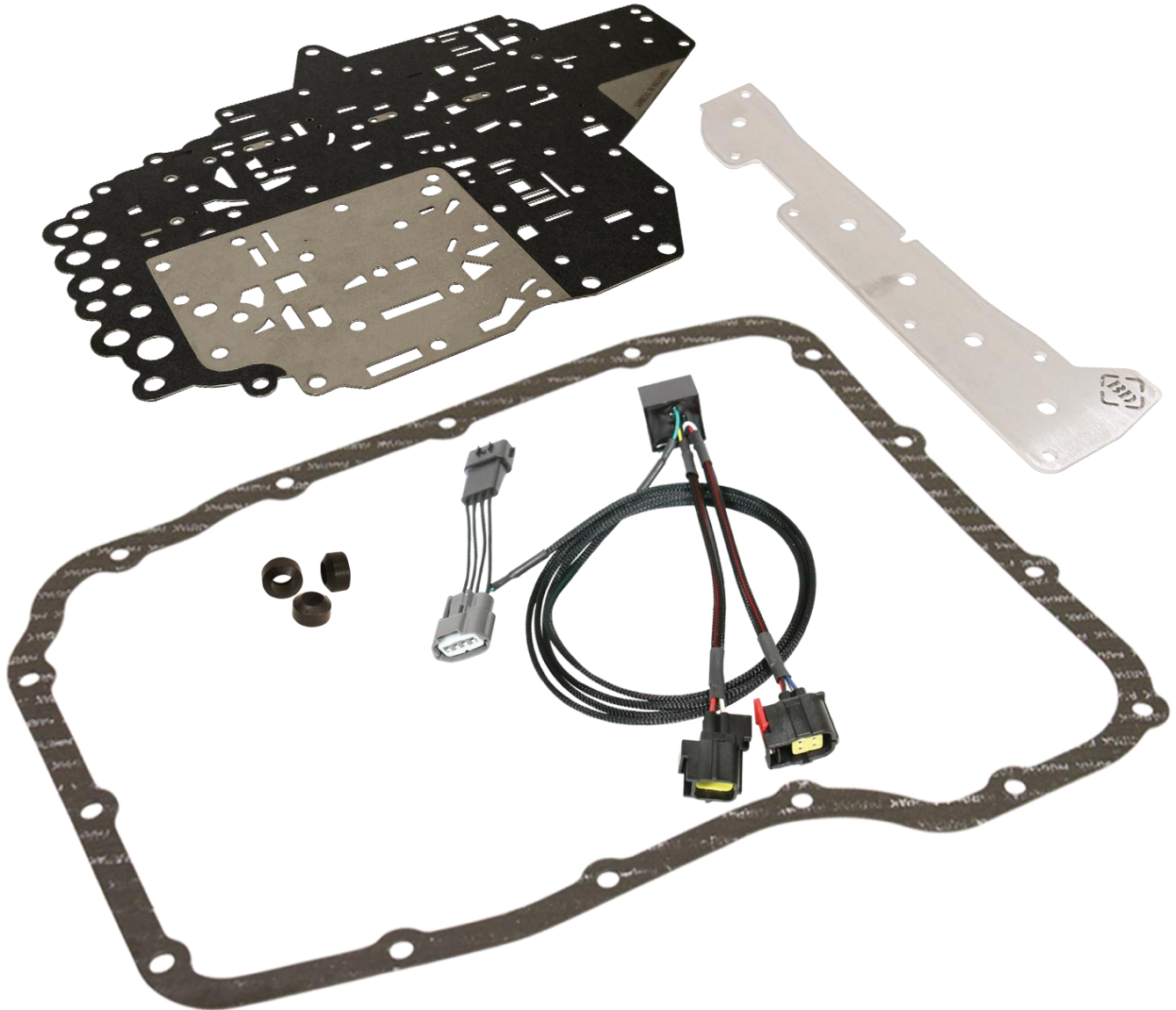

PROTECT68 PRESSURE CONTROL KIT

1030362 2007-2018 68RFE Transmission

PLEASE READ ALL INSTRUCTIONS BEFORE INSTALLATION

DOES NOT FIT 2019+ (BLUE CONNECTOR)

AFTERMARKET TUNERS OR TCMS

If using any aftermarket TCM tuning, the tuner must **NOT** increase mainline pressure. This will conflict with the BD pressure controller which will also increase line pressure. Using both the controller and tuning will set a P0868 fault code and may cause shift issues. Be sure to disable line pressure changes in your tuner or instead order BD 1030373 which does not include the pressure controller.

KIT CONTENTS

Please check to make sure that you have all the parts listed in this kit.

Kit Contents for 1030362		
1030369	4799778	1600186
		
68 RFE Pressure Controller Qty: 1	Clutch Feed Seal Qty: 3	Gasketed; Separator Plate Qty: 1

16001523	52118261	1600205
		
Gasket Qty: 1	Check Ball Qty: 2	Accumulator Plate Qty: 1

Tools Required

- Drain Pan
- Transmission Funnel
- 8mm Socket
- T25 Torx Socket
- Torque Wrench (in/lbs)
- Drill
- 1/8” Drill Bit
- Brake Clean or Parts Cleaner
- Center Punch
- Scraper

Upgrade Options

1030240	Torque Converter
1061525	6.7L HD Transmission Pan
1041220	6.7L Cummins Flex Plate
1061529	Adapter Tool – 68 RFE

Installation Video

Check out our YouTube video for install instructions, tips and critical installation steps.



<https://www.youtube.com/watch?v=fCoeMG2TFU>

Early Model / Late Model Transmission Identification



BD now supplies one kit for all 68RFE transmissions. It is no longer necessary to order a separate kit for early and late model transmissions. Pay attention to the instructions as they have changed.

Valve Body Installation

1. Ensure all kit components are accounted for before installation (including the small check ball!).
2. Disconnect vehicle batteries and secure cables away from batteries.
3. Lift transmission dip stick approx. 6 inches to avoid interference later on.
4. Raise vehicle on vehicle lift. If using a jack, use safety stands and chock wheels.

5. Remove shifter cable from transmission for better access to the main electrical connector.



6. To remove connector, push red tab (1) downwards. Then, press the black tab (2) which will allow the white handle (3) to be rotated downwards, releasing the connector from the transmission.

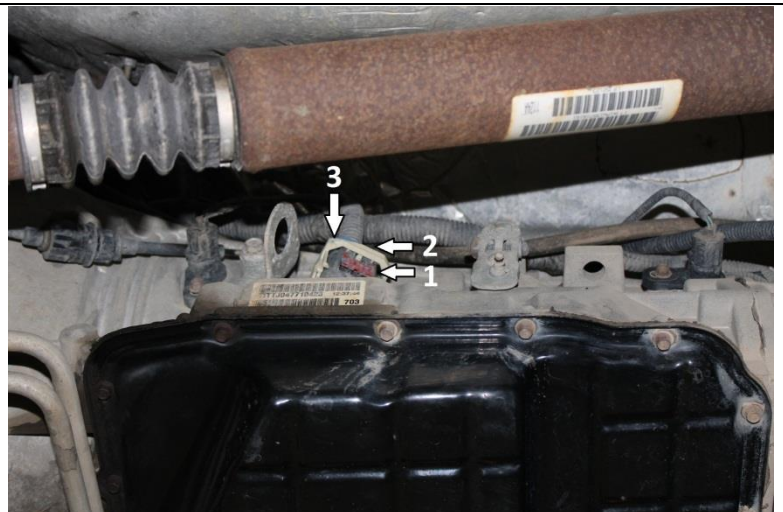

7. Position drain pan below the transmission.

8. Remove 14 of the 15 transmission pan bolts (8mm). Loosen the remaining bolt but leave in place to keep the pan from falling. The transmission cooler lines may need to be moved to access some of the bolts, gently pry them out of the way.



9. Tap pan with a mallet to break the silicone gasket seal. Allow fluid to drain. Remove last screw and drain remainder of fluid.



10. Remove transmission filter by removing the one T25 Torx screw.

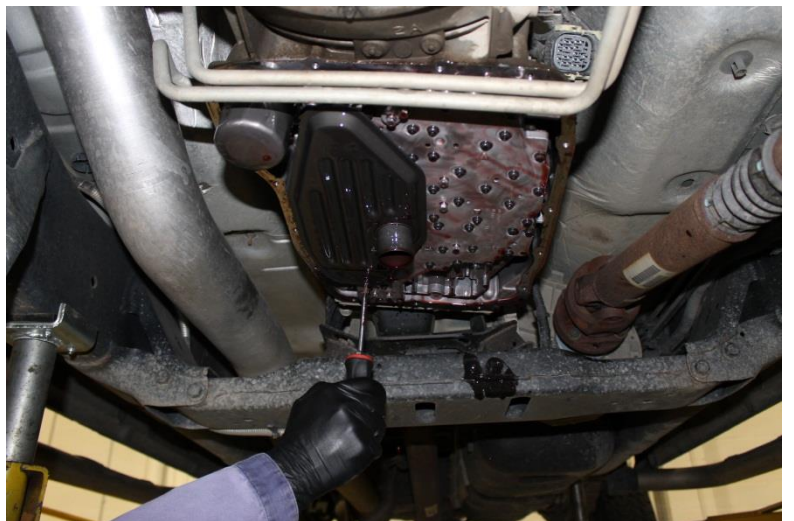

11. Remove the six 8mm bolts securing the valve body to the transmission. Drain valve body of fluid. To remove valve body from transmission, wiggle it while pulling downwards to work the electrical connector through the case.



12. Place the valve body on a clean work surface.

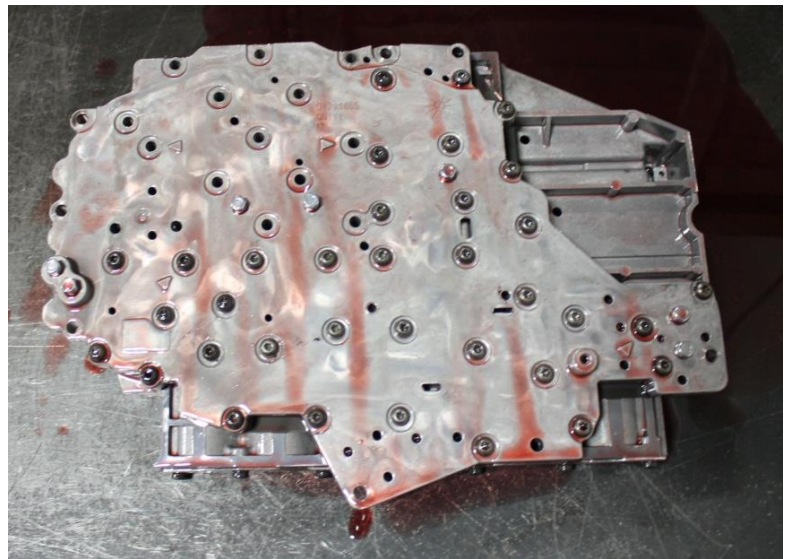

13. Remove fifteen T25 Torx screws securing the solenoid pack to the valve body, remove solenoid pack and place it to the side.

Note: All bolts are the same length.

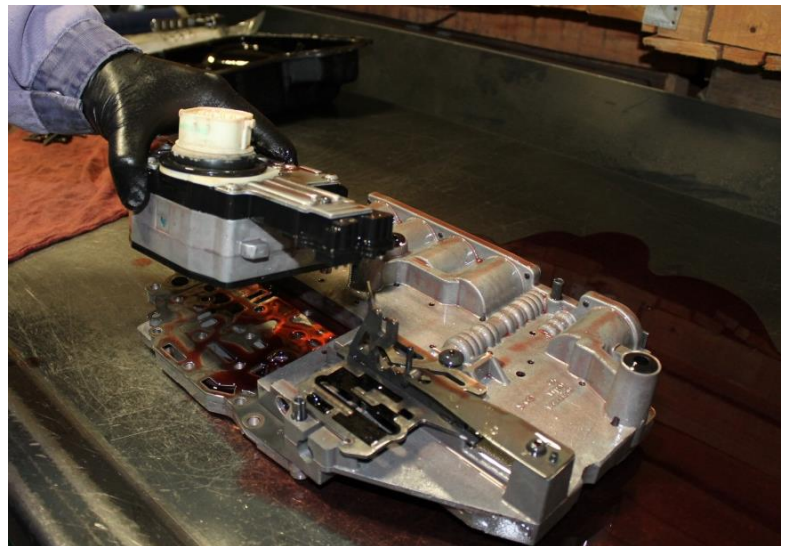

14. Remove remaining thirty-five T25 Torx screws securing the valve body halves.

Note: All bolts are the same length.

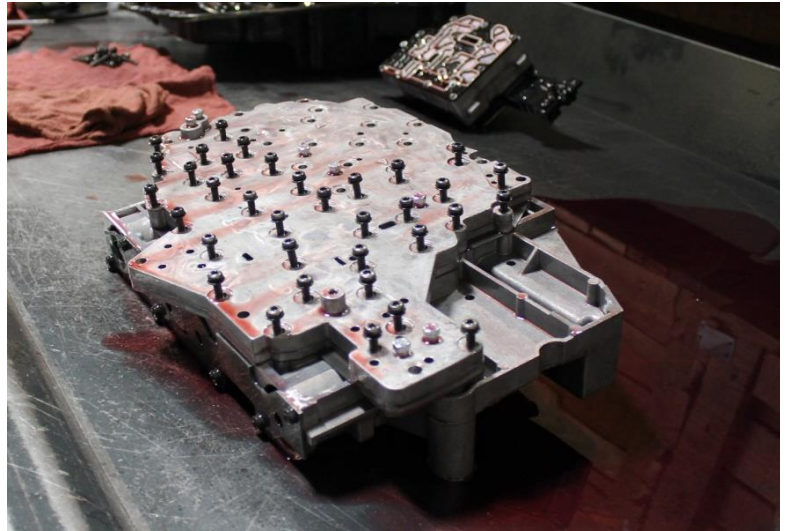

15. Carefully separate the two halves of the valve body. Separate as shown in pictures – *do not invert the larger (top) portion as it contains plastic check balls.* The two halves will have to be wiggled apart as the alignment dowels will be holding them together.

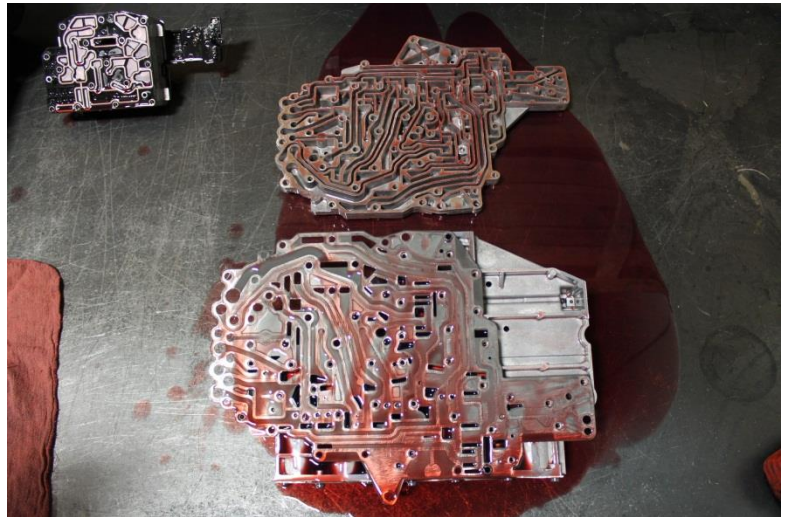

16. Remove old separator plate.

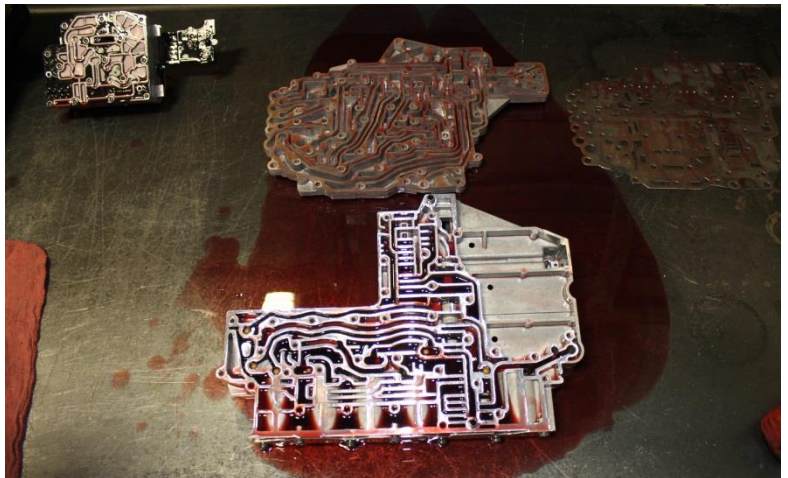

17. Thoroughly clean the bottom (smaller) half of the valve body. Locate the passage to be drilled.

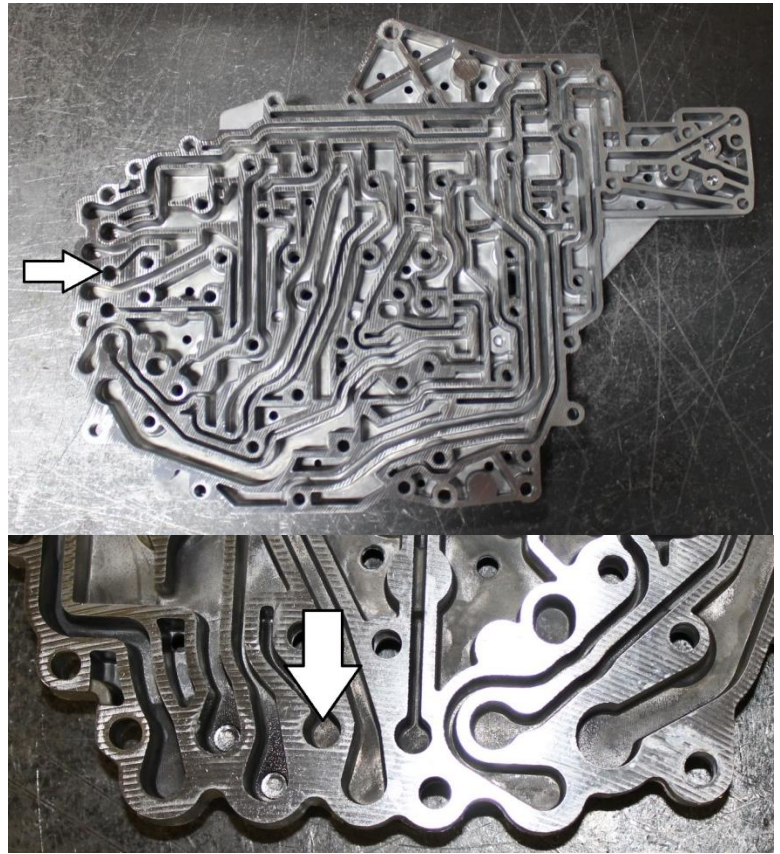

18. Punch center of hole using a center punch.



19. Drill hole with 1/8" drill bit.

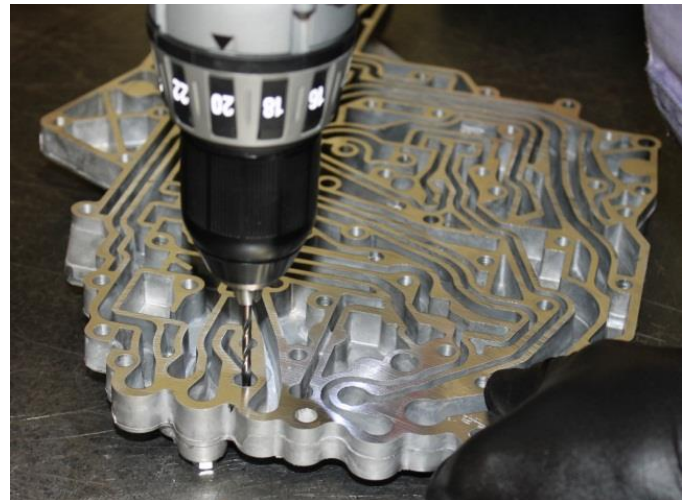

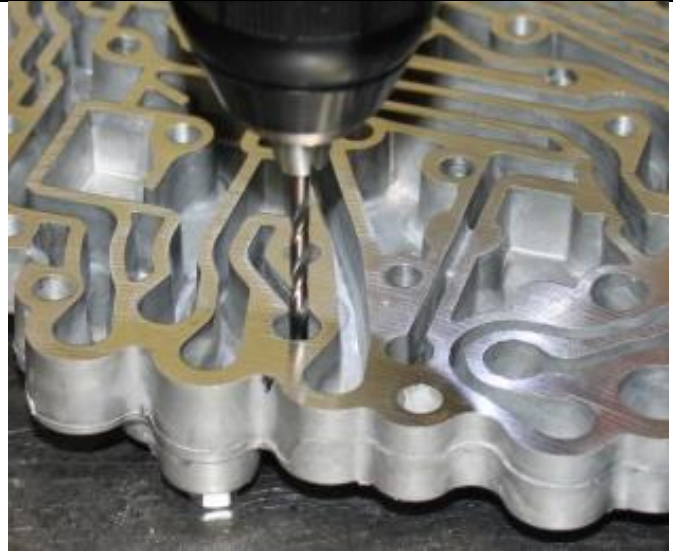

20. Thoroughly remove any burrs and clean all shavings from the valve body. It is imperative that no contaminants are left as they may cause transmission damage.



21. **IMPORTANT!** Ensure that all the check balls are in the locations shown.

If the electrical connector on the valve body is white make sure you have all seven check balls installed.

Discard any extra check balls.

If this part has been contaminated in any way, it must be thoroughly cleaned before reassembly.

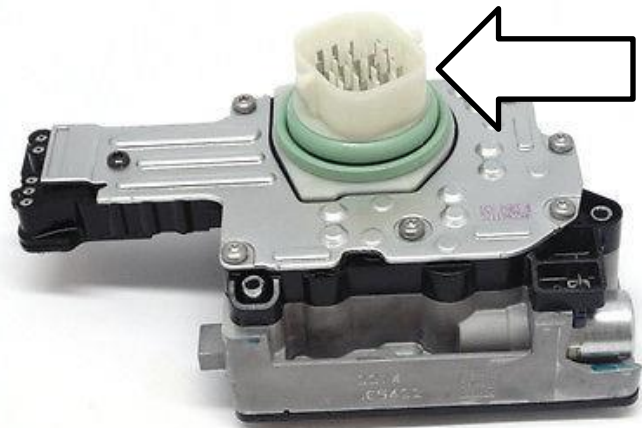

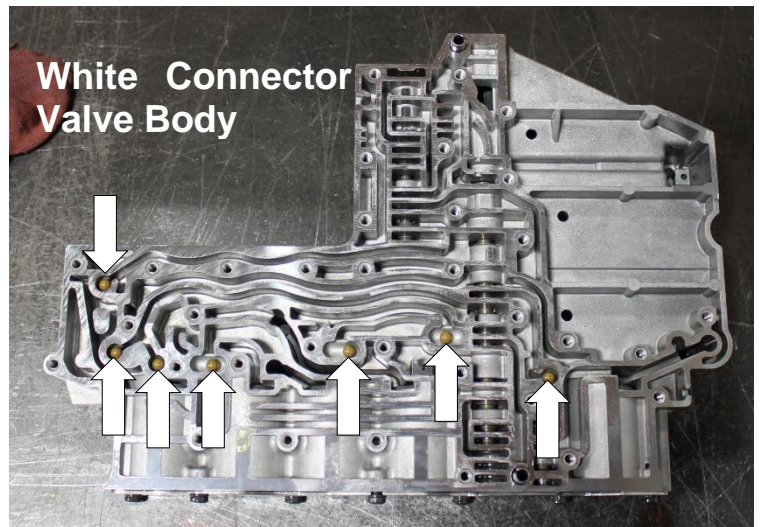

22. IMPORTANT! Ensure that all the check balls are in the locations shown.

If the electrical connector on the valve body is gray you will install six check balls rather than the five that were originally installed.

Use the supplied extra check ball included in this kit for this. Refer to the diagram on the right.

If this part has been contaminated in any way, it must be thoroughly cleaned before reassembly.

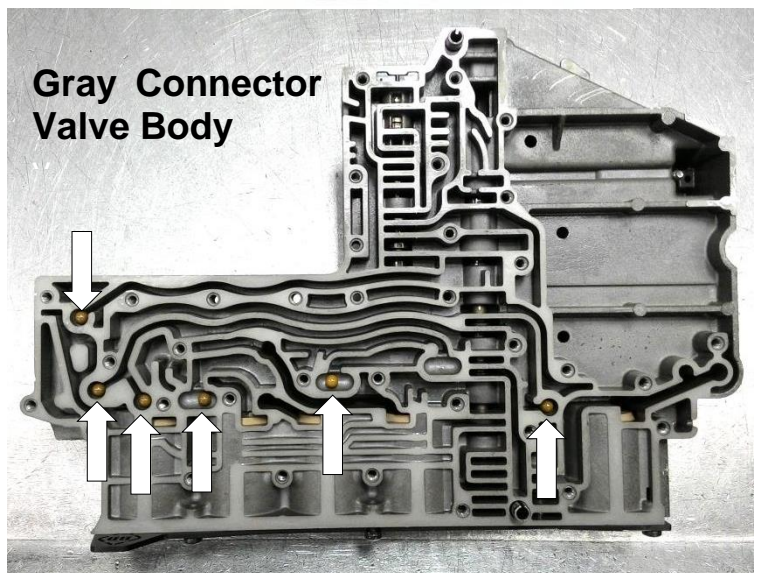
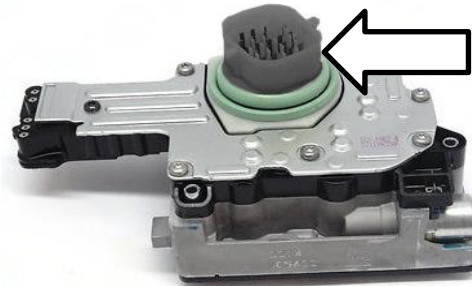

23. Install the BD bonded gasketed separator valve-body plate (1600188).

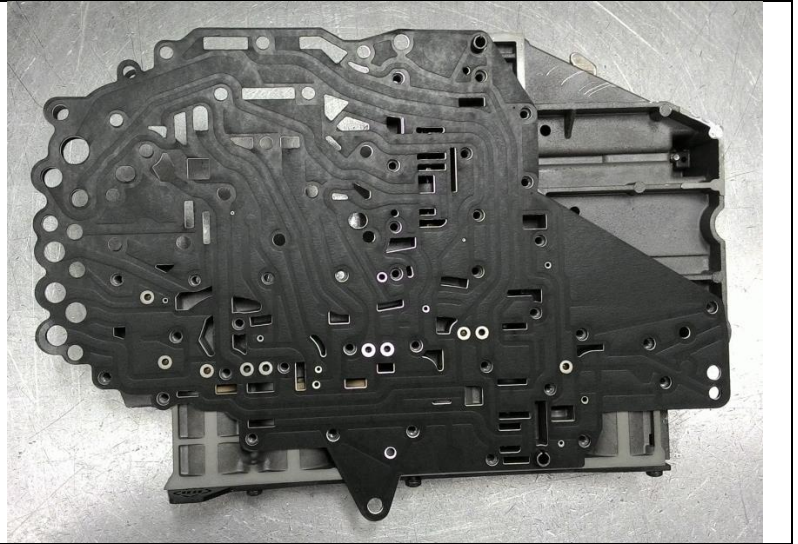

24. Re-install bottom (smaller) half of valve body. Ensure it fits flat on the separator plate/gasket. It may need to be worked downwards while rocking to be installed over the dowels. Install attaching screws so they are fully seated but do not tighten until the solenoid pack has been installed.

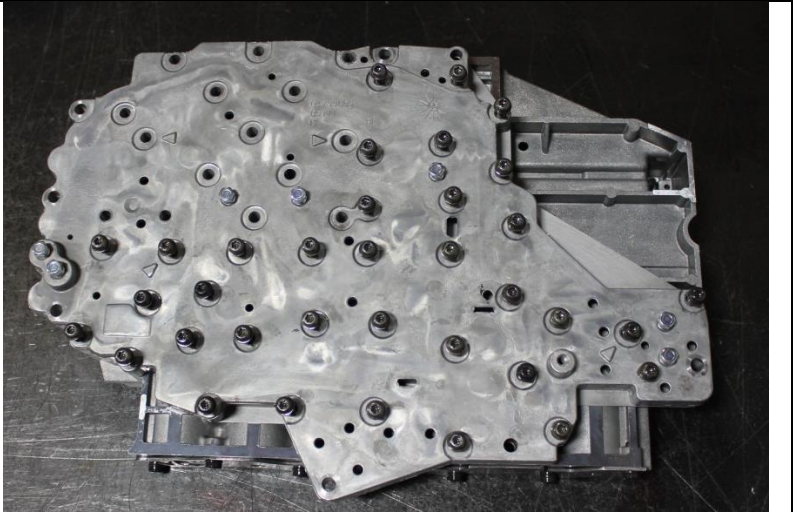

25. Re-install solenoid pack onto valve body. Be sure to properly align the pin on the solenoid pack with the slot on the valve body. Due to the alignment dowels, the valve body may need to be wiggled down into position. Install solenoid pack attaching screws. Install remaining Torx screws to fasten the solenoid pack to the valve body.

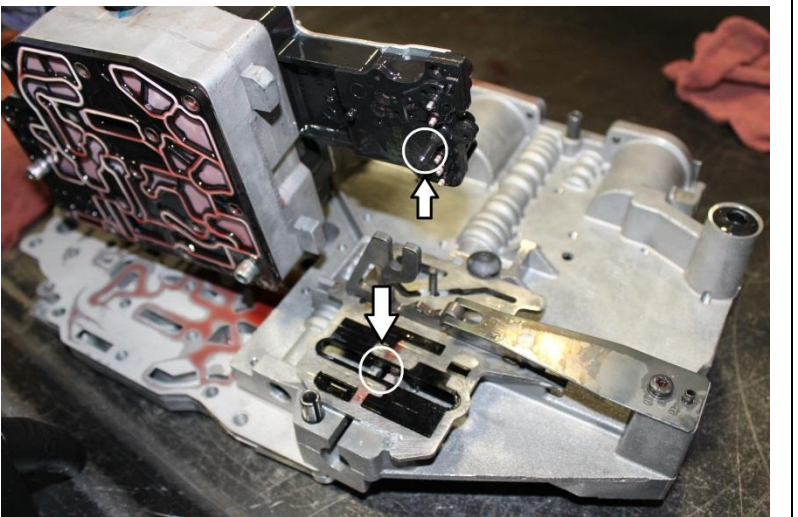

IMPORTANT! – On rare occasions, the solenoid pack gasket comes with a small nub on one side which will need to be removed using a file or blade before installation as the new plate blocks off the opening as it is not present on most applications.

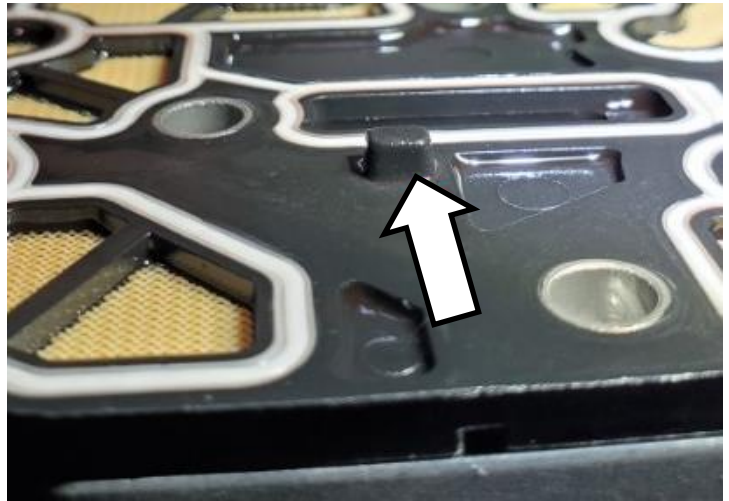

26. Torque all valve body Torx screws to 55 in-lbs, working from the center outwards. Carefully check that no screws were missed.

27. Remove the accumulator retainer plate and reinstall the supplied BD accumulator plate. **Torque screws to 50 in-lb.**

IMPORTANT: Over or under-torquing these fasteners can lead to blown out accumulator plates.

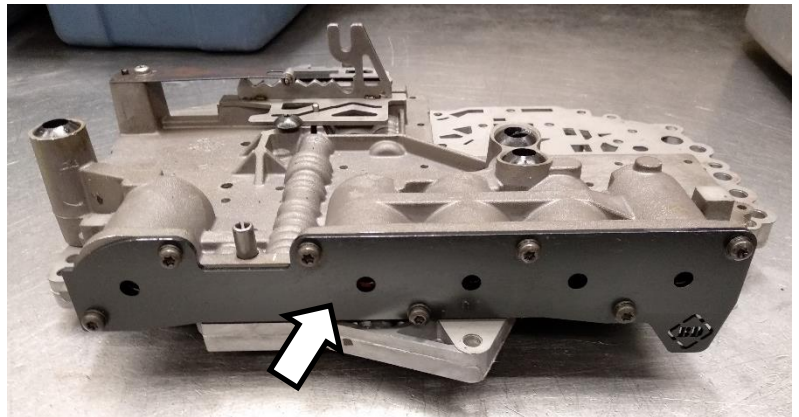

28. Inspect the three rubber seals on the top of the valve body, replace with supplied seals if they are nicked or otherwise damaged. Ensure the seal mating surface on the transmission is clean.

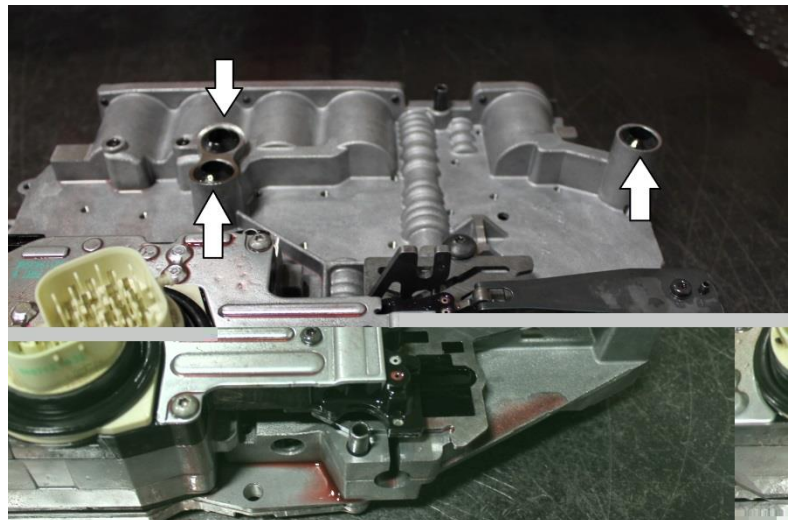

29. Wipe clean the bore on the transmission case around the electrical connector. Scrape all old silicone gasket material (if any) from the oil pan mating surfaces.

30. Check that the shift lever on the valve body lines up with the shift lever on the transmission and lift the valve body back into the transmission. Start the 8mm screws by hand, do not tighten yet. Work the shift lever on the outside of the transmission case by hand to ensure that the lever is making contact with the valve body correctly.

IMPORTANT: Use great care when reinstalling the valve body, the gasket that mates with the front of the case must line up correctly. Do not fold or pinch during installation.

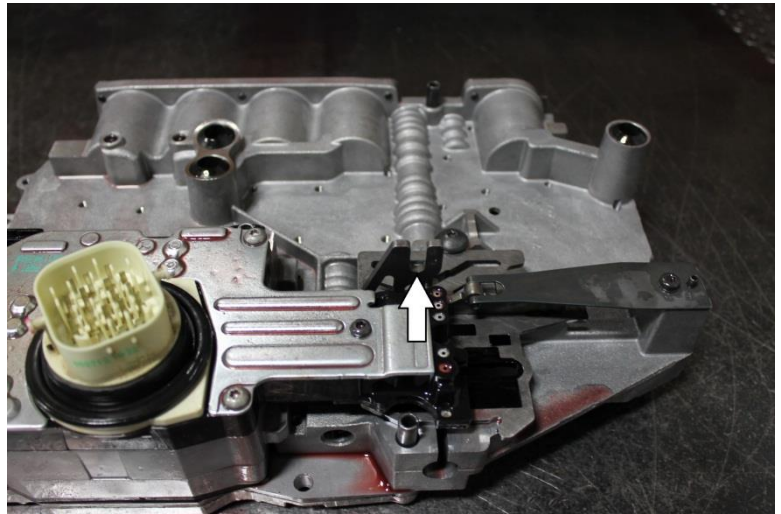

31. Torque the valve body attaching bolts to 105 in/lbs.



32. If desired, install new filter(s). Otherwise, reinstall the filter/pickup assembly. Torque to 50 in/lbs.



33. Place the supplied gasket on the transmission pan. Hold pan below transmission and install attaching screws. Torque the pan screws to 105 in/lbs.



34. Re-attach the transmission main electrical connector. Reattach shifter cable to shift lever.

35. Install the 68RFE pressure module according to the instructions included with it. Until this is installed the transmission will operate at stock line pressure.

IMPORTANT Connect the module to the MAP sensor on the driver's side of the engine NOT to the air intake sensor on the passenger side of the engine.

36. Lower vehicle.

37. Reconnect vehicle batteries.

38. Fill transmission fluid until COLD line is met. Start and run vehicle. Move shifter through different gears twice to fill valve body. Check for leaks. Check fluid level again. Top up as required.

39. Road test. Run through upshifts several times at light throttle to ensure transmission is shifting correctly. Shifts will feel firmer with increased throttle.

40. Recheck fluid level.

41. Note. If you would like to verify the increases in line pressure, use adapter kit (BD 1061529) in conjunction with a 300psi gauge. Pressures at wide open throttle should be between 240 – 260 PSI with a mechanical gauge.

ADAPTER KIT BD# 1061529



Use this kit with a 300 psi gauge.

TECH Bulletin – Protect68 Kit P0871

The protect68 kit is not designed to correct an already damaged transmission. Its purpose is to increase the reliability through increasing torque holding capacity of the transmission by increasing line pressure and eliminating cross leaks in the separator plate.

68RFE transmissions that run increased line pressure without a gasket (like the one included in this kit) may exhibit a P0871 due to cross leaks at the mating surface between the valve body halves. However, if this fault appears even after the installation of the gasket the problem may be a worn-out valve body.

By increasing main line pressure wear in the SSV bore may become more apparent. On high mileage transmissions the SSV valve bore may be worn, causing leakage into the overdrive hydraulic circuit. 2007.5-2009 trucks were highly susceptible to this damage. Model years after and including 2010 have an updated valve body that includes a hard-anodized coating which substantially increases lifespan. A hard-anodized valve body will be a dark gray color due to the coating.

The symptom would be a P0871 DTC (OD Pressure Switch Rationality fault). This DTC would normally be set in gears 1,2,3 at full throttle. If this is the case in which your vehicle has set this code before or after installing the protect68 your valve body has worn. The best solution is to purchase a new (revised) valve body from Chrysler with the hard-anodized coating. An alternative method is to ream the valve bore and install an oversized valve. This will resolve the problem for a while but it will eventually return.

If you would like to repair your valve body, please be aware that it is a difficult repair. Please take the valve body to a machine shop or a very experienced transmission repair facility that has the proper equipment.

You can purchase the repair kit from Sonnax.

Sonnax 92835-32K Oversized Solenoid Switch Valve & Plug Kit

Sonnax F-92835-TL31 Tool Kit (reamer tool)

Sonnax VB-FIX Valve Body Reaming Fixture (not required but recommended)

www.sonax.com