

7929 Lincoln Ave. Riverside, CA 92504
Phone: 951.689.ICON | Fax: 951.689.1016

PART #	DESCRIPTION
37705CP	99-UP FSD 4WD 0-3" REAR 2.5 VS PB CDCV PAIR

COMPONENTS INCLUDED	
(2) 134944PBC 99-UP FSD 4WD REAR 2.5 VS PB CDCV	
HARDWARE INCLUDED	
N/A	
TOOLS REQUIRED	
JACK JACK STANDS TORQUE WRENCH	18MM SOCKET / WRENCH 21MM SOCKET / WRENCH
TECH NOTES	
<p>1. YOUR ICON SHOCK ASSEMBLIES COME FACTORY CHARGED TO 150 PSI. RELEASING NITROGEN PRESSURE MAY LEAD TO SHOCK MALFUNCTION AND REDUCED RIDE QUALITY. FAILURE CAUSED BY LOW NITROGEN PRESSURE IS NOT COVERED UNDER ICON'S WARRANTY POLICY.</p> <p>2. THE LOWER HEIM SPACERS FOR 99-16 AND 17-UP ARE INCLUDED. USE THE 14MM SPACERS FOR 17-UP APPLICATIONS.</p>	



WARNING!
<p>** READ ALL INSTRUCTIONS THOROUGHLY FROM START TO FINISH BEFORE BEGINNING INSTALLATION! IF THESE INSTRUCTIONS ARE NOT PROPERLY FOLLOWED SEVERE FRAME, SUSPENSION AND TIRE DAMAGE MAY RESULT TO THE VEHICLE!</p> <p>** ICON VEHICLE DYNAMICS RECOMMENDS THAT YOU EXERCISE EXTREME CAUTION WHEN WORKING UNDER A VEHICLE THAT IS SUPPORTED WITH JACK STANDS.</p> <p>** ICON VEHICLE DYNAMICS RECOMMENDS ALL INSTALLATION TO BE PERFORMED BY A PROFESSIONAL SHOP/SERVICE TECHNICIAN. PRODUCT FAILURE CAUSED BY IMPROPER INSTALLATION WILL NOT BE COVERED UNDER ICON'S WARRANTY POLICY.</p>

INSTALLATION

- Using a properly rated jack, raise the front of the vehicle and support the frame rails with jack stands. Ensure the jack stands are secure and set properly before lowering the jack. NEVER WORK UNDER AN UNSUPPORTED VEHICLE.
- Remove the factory shocks using 18mm and 21mm socket/wrench.
- Slide the wider spacer onto the stud on the upper shock mount. Slide the shock into the shock mount with the reservoir facing away from the axle. The driver side reservoir may need to be clocked (toward the spare tire) away from a wiring harness. Slide the wide spacer on to the stud, followed by the upper shock eyelet, then the narrow spacer. [Torque to factory spec] [FIGURE 1 & 2]

FIG.1



FIG.2



4. Position the rod end in the lower mount and slide the bolt in. There are 2 sets of lower spacers provided. 99-16 FSDs have a 12mm bolt. 17-UP FSDs have 14mm bolt. Use the correct spacers for your vehicle. If using the 14mm bolt, offset the rod end toward the wheel. [Torque to factory spec] [FIGURE 3]



FIG.3

VERIFY ALL FASTENERS ARE PROPERLY TORQUED BEFORE DRIVING VEHICLE.

RETORQUE ALL NUTS, BOLTS AND LUGS AFTER 100 MILES AND PERIODICALLY THEREAFTER.

2.5 VS SERIES SHOCK & COILOVER TECHNICAL INFORMATION

MAINTENANCE

ICON shock absorbers are a high quality rebuildable race style shock absorber designed for optimal performance. With a unit of this caliber on your vehicle, routine maintenance is required to keep them looking and operating in like new condition. Residual oil and assembly lube may be present at all seal paths from the factory out of the box and is considered normal. Pooling of oil however is not acceptable at any time and one should contact the ICON dealer where purchased.

BELOW ARE GUIDELINES BASED ON HOW YOU USE YOUR VEHICLE BUT YOUR MILEAGE MAY VARY:

STREET USE:

- Send in for factory servicing every 40,000 miles or if a leak develops, ride quality decreases, or they begin to make excessive noise.
- Remove any buildup of road salt, mud, or debris from shocks and coil springs anytime accrued
- Clean with mild soap and water with each oil change or anytime you notice build up.
- Wax the cylinders yearly with automotive wax to prevent corrosion.
- Check nitrogen pressure yearly. (252004 charge needle assembly available at any ICON distributor)
- Check bearings for excessive wear yearly.
- DO NOT apply any type of lube to the upper and lower bearings.

STREET/DIRT:

- Send in for factory servicing every 15,000 miles or if a leak develops, ride quality decreases, or they begin to make excessive noise.
- Clean with mild soap and water with each oil change, offroad trip, or anytime you notice build up.
- Wax the cylinders yearly with automotive wax to prevent corrosion.
- Check nitrogen pressure each dirt outing. (252004 charge needle assembly available at any ICON distributor)
- Check bearings for excessive wear yearly.
- DO NOT apply any type of lube to the upper and lower bearings.

DIRT USE:

- Send in for factory servicing every 1,000 miles.
- Check nitrogen pressure each outing. (252004 charge needle assembly available at any ICON distributor)
- Remove any buildup of mud or debris from shocks and coil springs after every outing.

SELF-SERVICE:

- Contact ICON for service kits & tools at (951) 689-4266.

PRODUCT REGISTRATION

Please visit: <http://www.iconvehicledynamics.com/tech-support/registration/> to register your product.

ICON VEHICLE DYNAMICS SHOCK ABSORBER WARRANTY

This shock absorber has a 1 year warranty against any manufacturer's defects. If a shock fails within the initial year of ownership, the shock must be shipped to ICON Vehicle Dynamics for inspection and service. If a shock is inspected and it has been determined the shock failed due to neglect, damage caused by improper installation or any other reason besides "normal wear and tear", the owner of said shock is responsible for all service costs. This includes labor, parts, and shipping.

ICON Vehicle Dynamics warrants to the original retail purchaser who owns the vehicle on which the product was originally installed. ICON Vehicle Dynamics does not warrant the product for finish, alterations, modifications and/or installation contrary to ICON Vehicle Dynamics instructions. ICON Vehicle Dynamics products are not designed, nor are they intended to be installed on vehicles used in race applications, for racing purposes or for similar activities. (A "race" is defined as any contest between two or more vehicles, or a contest of one or more vehicles against the clock, whether or not such contest is for a prize). This warranty does not include coverage for police or taxi vehicles, race vehicles, or vehicles used for government or commercial purposes. Also excluded from this warranty are sales outside of the United States of America and Canada.

ICON Vehicle Dynamics' obligation under this warranty is limited to the repair or replacement, at ICON Vehicle Dynamics' discretion, of the defective product. Any and all costs of removal, installation or re-installation, freight charges and incidental or consequential damages are expressly excluded from this warranty. Items that are subject to wear are not considered defective when worn and are not covered.

ICON Vehicle Dynamics components must be installed as a complete kit as shown in our current application guide. Any substitutions or exemptions of required components will immediately void the warranty. Some finish damage may happen to parts during shipping and is not covered under warranty.

This warranty is expressly in lieu of all other warranties expressed or implied. This warranty shall not apply to any product that has been improperly installed, modified or customized subject to accident, negligence, abuse or misuse.

To send a shock in for warranty please visit our website <http://www.iconvehicledynamics.com/tech-support/shock-service/>

7929 Lincoln Ave. Riverside, CA 92504
Phone: 951.689.ICON | Fax: 951.689.1016

PART #	DESCRIPTION
62510	05-UP FSD FRONT 2.5 DUAL RATE COIL KIT

COMPONENTS INCLUDED	
(2) 168500 05+ FSD 2.5 DUAL RATE COIL SPRING	(2) 167008 FSD ALIGNMENT CAM (2) 605900 1/8 X 2.000 COTTER PIN
HARDWARE INCLUDED	
N/A	
TOOLS REQUIRED	
JACK JACK STANDS PLIERS TORQUE WRENCH HAMMER BALL JOINT SEPARATOR	3/4" SOCKET / WRENCH 10MM SOCKET / WRENCH 13MM SOCKET / WRENCH 18MM SOCKET / WRENCH 21MM SOCKET / WRENCH 30MM SOCKET / WRENCH
TECH NOTES	
<p>1. LIFT HEIGHTS ARE BASED ON CREW CAB DIESEL F-250 CONFIGURATIONS.</p> <p>2. ALIGNMENT CAM INSTALLATION NOT REQUIRED FOR VEHICLES EQUIPED WITH ICON RADIUS ARM SYSTEM (#64041).</p>	



WARNING!
<p>** READ ALL INSTRUCTIONS THOROUGHLY FROM START TO FINISH BEFORE BEGINNING INSTALLATION! IF THESE INSTRUCTIONS ARE NOT PROPERLY FOLLOWED SEVERE FRAME, SUSPENSION AND TIRE DAMAGE MAY RESULT TO THE VEHICLE!</p> <p>** ICON VEHICLE DYNAMICS RECOMMENDS THAT YOU EXERCISE EXTREME CAUTION WHEN WORKING UNDER A VEHICLE THAT IS SUPPORTED WITH JACK STANDS.</p> <p>** ICON VEHICLE DYNAMICS RECOMMENDS ALL INSTALLATION TO BE PERFORMED BY A PROFESSIONAL SHOP/SERVICE TECHNICIAN. PRODUCT FAILURE CAUSED BY IMPROPER INSTALLATION WILL NOT BE COVERED UNDER ICON'S WARRANTY POLICY.</p>

INSTALLATION

- Using a properly rated jack, raise the front of the vehicle and support the frame rails with jack stands. Ensure the jack stands are secure and set properly before lowering the jack. NEVER WORK UNDER AN UNSUPPORTED VEHICLE. Remove front wheels.
- Remove the sway bar links from the sway bar using an 18mm socket/wrench. Leave them connected to the differential. [FIGURE 1]

FIG.1

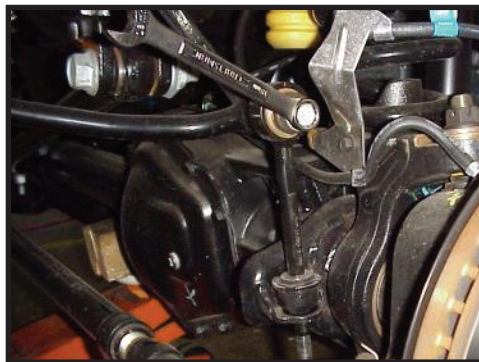
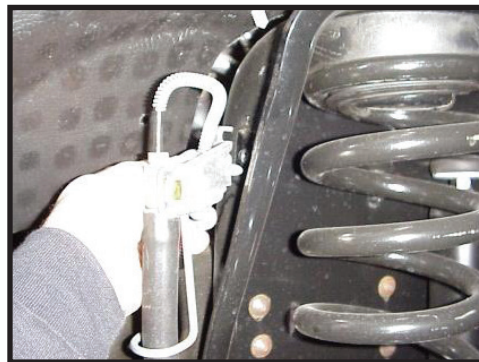

FIG.2



- Disconnect the upper brake line brackets from the frame using a 13mm socket/wrench and lower brake line brackets from the differential using a 10mm socket/wrench. [FIGURE 2]

- 4.** On the driver side of the track bar, remove the nut and the upper track bar bolt using (2) 30mm socket/wrenches. [FIGURE 3]

FIG.3

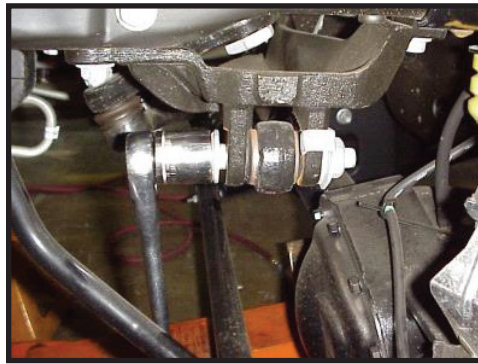

- 5.** Support the axle with a floor jack and remove the front shocks. The shocks are limiting droop so make sure that the axle is supported or it will fall when the shocks are removed. (21mm socket/wrench, 18mm socket/wrench)
- 6.** Slowly lower the axle, the coils will unload from the mounts and can be removed. Be careful not to stretch or damage any lines connected to the axle or radius arms.
- 7.** Lower the axle just enough to install the new springs. Place the original rubber isolator on top of the new coil and install. Be careful to not stretch or damage any lines. Check the rotation/clocking of the coil to make sure it is properly seated in the lower spring perch.
- 8.** Lift the axle high enough to connect the shocks but be careful not to lift the truck off of its supports. Use the original bolt on the lower shock mount and tighten with an 18mm socket/wrench [Torque to factory spec]. Tighten the stem top nut using a 3/4" socket/wrench. (Refer to shock Instructions)
- 9.** Install the alignment cams (167008). Remove the cotter pin from the ball joint castle nut then remove the castle nut from the upper ball joint using a 24mm. Using a hammer (or ball joint separator), strike the knuckle to dislodge the taper, be careful not to damage the threads. Remove stock alignment cam.
- 10.** Install the new alignment cam: Make sure the arrow is pointing toward the front of the truck and the flat end of the cam is aligned with the flat end of the knuckle. Use the old sleeve to tap the new one down into the taper. Install the castle nut using a 24mm [Torque to 69 ft-lbs]. Install the new cotter pin.
- 11.** Repeat steps 9-11 for the opposite side.
- 12.** Connect the sway bar links to the sway bar using an 18mm socket/wrench. [Torque to factory spec]
- 13.** Reconnect the upper brake line bracket to the frame using a 13mm socket/wrench and the lower bracket using a 10mm socket/wrench [Torque to factory spec]. Depending on the year of the truck, the brake line may need to be manipulated down to not overextend at full droop.
- 14.** Reconnect the track bar using (2) 30mm socket/wrenches. [Torque to factory spec]
- 15.** Install the wheels and lower the vehicle to the ground.
- 16.** Have the vehicle professionally aligned.

VERIFY ALL FASTENERS ARE PROPERLY TORQUED BEFORE DRIVING VEHICLE.

RETORQUE ALL NUTS, BOLTS AND LUGS AFTER 100 MILES AND PERIODICALLY THEREAFTER.

ICON VEHICLE DYNAMICS LIMITED LIFETIME WARRANTY

ICON Vehicle Dynamics warrants to the original retail purchaser who owns the vehicle on which the product was originally installed. ICON Vehicle Dynamics does not warrant the product for finish, alterations, modifications and/or installation contrary to ICON Vehicle Dynamics instructions. ICON Vehicle Dynamics products are not designed, nor are they intended to be installed on vehicles used in race applications, for racing purposes or for similar activities. (A "race" is defined as any contest between two or more vehicles, or a contest of one or more vehicles against the clock, whether or not such contest is for a prize). This warranty does not include coverage for police or taxi vehicles, race vehicles, or vehicles used for government or commercial purposes. Also excluded from this warranty are sales outside of the United States of America and Canada.

ICON Vehicle Dynamics' obligation under this warranty is limited to the repair or replacement, at ICON Vehicle Dynamics' discretion, of the defective product. Any and all costs of removal, installation or re-installation, freight charges and incidental or consequential damages are expressly excluded from this warranty. Items that are subject to wear are not considered defective when worn and are not covered.

ICON Vehicle Dynamics components must be installed as a complete kit as shown in our current application guide. Any substitutions or exemptions of required components will immediately void the warranty. Some finish damage may happen to parts during shipping and is not covered under warranty.

This warranty is expressly in lieu of all other warranties expressed or implied. This warranty shall not apply to any product that has been improperly installed, modified or customized subject to accident, negligence, abuse or misuse.



ICON VEHICLE DYNAMICS®
PERFORMANCE SUSPENSION SYSTEMS AND SHOCK ABSORBERS

7929 Lincoln Ave. Riverside, CA 92504 Phone: 951.689.ICON Fax: 951.689.1016
www.iconvehicledynamics.com



FOLLOW US ON FACEBOOK!



7929 Lincoln Ave. Riverside, CA 92504
 Phone: 951.689.ICON Fax: 951.689.1016

PART #	DESCRIPTION
64037	2005-UP FSD FRONT 2" FRONT BUMP STOP SPACER KIT

COMPONENTS INCLUDED	
(2) 167004 05-UP FSD FRONT 2" BUMP STOP SPACER	
HARDWARE INCLUDED	
(2) 605803 M8-1.25 X 70MM BOLT	
TOOLS REQUIRED	
TORQUE WRENCH	10MM SOCKET / WRENCH
TECH NOTES	
<p>1. IF INSTALLING ICON (65000) KIT ON A TRUCK THAT DOES NOT HAVE A BUMP STOP SPACER, THIS KIT IS REQUIRED TO ALLOW FOR CROSS MEMBER CLEARANCE AT FULL SUSPENSION COMPRESSION. THE PARTS IN THIS KIT (64037) ARE INCLUDED IN ICON'S 4.5" LIFT AND 7" SYSTEMS</p>	



WARNING!
<p>** READ ALL INSTRUCTIONS THOROUGHLY FROM START TO FINISH BEFORE BEGINNING INSTALLATION! IF THESE INSTRUCTIONS ARE NOT PROPERLY FOLLOWED SEVERE FRAME, SUSPENSION AND TIRE DAMAGE MAY RESULT TO THE VEHICLE!</p> <p>** ICON VEHICLE DYNAMICS RECOMMENDS THAT YOU EXERCISE EXTREME CAUTION WHEN WORKING UNDER A VEHICLE THAT IS SUPPORTED WITH JACK STANDS.</p> <p>** ICON VEHICLE DYNAMICS RECOMMENDS ALL INSTALLTION TO BE PERFORMED BY A PROFESSIONAL SHOP/SERVICE TECHNICIAN. PRODUCT FAILURE CAUSED BY IMPROPER INSTALLATION WILL NOT BE COVERED UNDER ICON'S WARRANTY POLICY.</p>

INSTALLATION

1. Pry the front bump stops out of the bump stop cup. Remove the bolt in the center of the cup using a 10mm. Install the supplied bump stop spacer between the cup and the frame with the supplied bolt. The cup has a flat side on its outer flange. Rotate the flat side to be near the coil spring for added clearance. [Torque to factory spec] [FIGURE 1]

FIG.1



VERIFY ALL FASTENERS ARE PROPERLY TORQUED BEFORE DRIVING VEHICLE.

RETORQUE ALL NUTS, BOLTS AND LUGS AFTER 100 MILES AND PERIODICALLY THEREAFTER.

ICON VEHICLE DYNAMICS LIMITED LIFETIME WARRANTY

ICON Vehicle Dynamics warrants to the original retail purchaser who owns the vehicle on which the product was originally installed. ICON Vehicle Dynamics does not warrant the product for finish, alterations, modifications and/or installation contrary to ICON Vehicle Dynamics instructions. ICON Vehicle Dynamics products are not designed, nor are they intended to be installed on vehicles used in race applications, for racing purposes or for similar activities. (A "race" is defined as any contest between two or more vehicles, or a contest of one or more vehicles against the clock, whether or not such contest is for a prize). This warranty does not include coverage for police or taxi vehicles, race vehicles, or vehicles used for government or commercial purposes. Also excluded from this warranty are sales outside of the United States of America and Canada.

ICON Vehicle Dynamics' obligation under this warranty is limited to the repair or replacement, at ICON Vehicle Dynamics' discretion, of the defective product. Any and all costs of removal, installation or re-installation, freight charges and incidental or consequential damages are expressly excluded from this warranty. Items that are subject to wear are not considered defective when worn and are not covered.

ICON Vehicle Dynamics components must be installed as a complete kit as shown in our current application guide. Any substitutions or exemptions of required components will immediately void the warranty. Some finish damage may happen to parts during shipping and is not covered under warranty.

This warranty is expressly in lieu of all other warranties expressed or implied. This warranty shall not apply to any product that has been improperly installed, modified or customized subject to accident, negligence, abuse or misuse.

ICON VEHICLE DYNAMICS

PERFORMANCE SUSPENSION SYSTEMS AND SHOCK ABSORBERS

7929 Lincoln Ave. Riverside, CA 92504 Phone: 951.689.ICON Fax: 951.689.1016
www.iconvehicledynamics.com



FOLLOW US ON FACEBOOK!



7929 Lincoln Ave. Riverside, CA 92504
 Phone: 951.689.ICON Fax: 951.689.1016

PART #	DESCRIPTION
64038	2017-UP FSD ADJUSTABLE TRACK BAR KIT

COMPONENTS INCLUDED	
(1) 164037 2017-UP FSD ADJUSTABLE TRACK BAR (2) 167021 HEIM SPACER JM16 X .812 X 1.750 (1) 167027 LEFT/RIGHT ADJUSTER ROUND (1) 168001 05-UP TRACK BAR BALL JOINT W/NUT	(1) 295513 JM16-1T, 1-14 LH ROD END F1 FIT (2) 605145 3/8-16 X 1.000 12PT SCREW (1) 605951 SPIRAL RETAINING RING
HARDWARE INCLUDED	
N/A	
TOOLS REQUIRED	
TAPE MEASURE BALL JOINT SEPARATOR HAMMER 1/4" SPANNER WRENCH TORQUE WRENCH	3/8" 12PT SOCKET / WRENCH 13MM SOCKET / WRENCH 27MM SOCKET / WRENCH 30MM SOCKET / WRENCH (2)
TECH NOTES	
1. DO NOT EXCEED 3.375" OF ADJUSTMENT FROM THE CENTER OF THE ROD END TO THE EDGE OF THE TRACK BAR PINCH HOUSING. FAILURE CAUSED BY EXCESSIVE ADJUSTMENT WILL NOT BE COVERED UNDER ICON'S WARRANTY POLICY.	



WARNING!

**** READ ALL INSTRUCTIONS THOROUGHLY FROM START TO FINISH BEFORE BEGINNING INSTALLATION! IF THESE INSTRUCTIONS ARE NOT PROPERLY FOLLOWED SEVERE FRAME, SUSPENSION AND TIRE DAMAGE MAY RESULT TO THE VEHICLE!**

**** ICON VEHICLE DYNAMICS RECOMMENDS THAT YOU EXERCISE EXTREME CAUTION WHEN WORKING UNDER A VEHICLE THAT IS SUPPORTED WITH JACK STANDS.**

**** ICON VEHICLE DYNAMICS RECOMMENDS ALL INSTALLTION TO BE PERFORMED BY A PROFESSIONAL SHOP/SERVICE TECHNICIAN. PRODUCT FAILURE CAUSED BY IMPROPER INSTALLATION WILL NOT BE COVERED UNDER ICON'S WARRANTY POLICY.**

INSTALLATION

1. Remove the stock track bar from the frame bracket using (2) 30mm sockets/wrenches. The vehicle may shift slightly.
2. Remove the track bar from the ball joint taper on the axle. Using a 27mm, remove the nut and separate the ball joint using a ball joint separator and hammer.
3. Connect the ICON track bar to the axle. Use a 13mm to keep the tapered stud from spinning while tightening the nut with a 27mm socket/wrench. [Torque to factory spec] [FIGURE 1]

FIG.1



4. Loosen the pinch bolts using a 3/8" 12pt socket/wrench.
5. Adjust the collar of the track bar while keeping the threaded bushing housing from spinning. Adjust as needed to line up in the frame bracket.

6. Install the factory upper track bar bolt using (2) 30mm sockets/wrenches. [Torque to 406 ft-lbs] [FIGURE 2]

FIG.2



NOTE: This track bar is adjustable from 36.75" - 37.75". The stock track bar measures 36.625" from eye to eye.

7. Adjust the collar to center the axle under the frame. Do not exceed the maximum adjustment range as outlined in the tech notes.

8. Tighten the pinch bolts using an alternating pattern and a 3/8" 12pt socket/wrench. [Torque to 35 ft-lbs]

9. Use the drag link adjustment to center the steering wheel before driving.

10. Have the vehicle professionally aligned.

VERIFY ALL FASTENERS ARE PROPERLY TORQUED BEFORE DRIVING VEHICLE.

RETORQUE ALL NUTS, BOLTS AND LUGS AFTER 100 MILES AND PERIODICALLY THEREAFTER.

ICON VEHICLE DYNAMICS LIMITED LIFETIME WARRANTY

ICON Vehicle Dynamics warrants to the original retail purchaser who owns the vehicle on which the product was originally installed. ICON Vehicle Dynamics does not warrant the product for finish, alterations, modifications and/or installation contrary to ICON Vehicle Dynamics instructions. ICON Vehicle Dynamics products are not designed, nor are they intended to be installed on vehicles used in race applications, for racing purposes or for similar activities. (A "race" is defined as any contest between two or more vehicles, or a contest of one or more vehicles against the clock, whether or not such contest is for a prize). This warranty does not include coverage for police or taxi vehicles, race vehicles, or vehicles used for government or commercial purposes. Also excluded from this warranty are sales outside of the United States of America and Canada.

ICON Vehicle Dynamics' obligation under this warranty is limited to the repair or replacement, at ICON Vehicle Dynamics' discretion, of the defective product. Any and all costs of removal, installation or re-installation, freight charges and incidental or consequential damages are expressly excluded from this warranty. Items that are subject to wear are not considered defective when worn and are not covered.

ICON Vehicle Dynamics components must be installed as a complete kit as shown in our current application guide. Any substitutions or exemptions of required components will immediately void the warranty. Some finish damage may happen to parts during shipping and is not covered under warranty.

This warranty is expressly in lieu of all other warranties expressed or implied. This warranty shall not apply to any product that has been improperly installed, modified or customized subject to accident, negligence, abuse or misuse.

ICON VEHICLE DYNAMICS

PERFORMANCE SUSPENSION SYSTEMS AND SHOCK ABSORBERS

7929 Lincoln Ave. Riverside, CA 92504 Phone: 951.689.ICON Fax: 951.689.1016
www.iconvehicledynamics.com



FOLLOW US ON FACEBOOK!



7929 Lincoln Ave. Riverside, CA 92504
Phone: 951.689.ICON | Fax: 951.689.1016

PART #	DESCRIPTION
65000	2005-UP FSD DUAL STABILIZER KIT

COMPONENTS INCLUDED

(1) 164004 05-UP FSD STEERING STABILIZER CENTER BRACKET (4) 167009 05-UP FSD STEERING STABILIZER TIE ROD CLAMP	(1) 65000H 05-UP FSD DUAL STABILIZER HARDWARE KIT
---	---

HARDWARE INCLUDED

65000H HARDWARE KIT

(4) 169003 SLEEVE .750 X .510 X .250 (2) 605107 3/8-16 X 1.250 FLANGE BOLT (2) 605221 7/16-20 NYLOCK NUT (2) 605230 7/16 FLAT WASHER (1) 605240 7/16-20 U-BOLT 3.750 ID X 4.00	(2) 605310 1/2-13 X 3.500 BOLT (2) 605319 1/2-13 X 2.000 BOLT (2) 605321 1/2-13 LOCK NUT (8) 605330 1/2 FLAT WASHER
--	--

TOOLS REQUIRED

TORQUE WRENCH 15MM SOCKET / WRENCH 18MM SOCKET / WRENCH	9/16" SOCKET / WRENCH 5/8" SOCKET / WRENCH 3/4" SOCKET / WRENCH
---	---

TECH NOTES

1. WIDE TRACK AXLE EQUIPPED TRUCKS MUST HAVE THE SHOCKS MOUNTED WITH THE BODY SIDE TOWARDS THE WHEEL UNLESS (64036) SPACER KIT IS USED.
2. A 1.5" BUMP STOP SPACER (MINIMUM) IS REQUIRED TO KEEP THE CENTER BRACKET FROM HITTING THE ENGINE CROSSMEMBER AT FULL SUSPENSION COMPRESSION. AN ICON 2" SPACER KIT IS AVAILABLE (64037). IF YOU HAVE AN ICON 4.5" OR 7" LIFT SYSTEM, THE BUMPTOP SPACER IS INCLUDED IN THE SYSTEM.
3. STANDARD TRACK FRONT AXLE STABILIZER SHOCK PART NUMBER: 36511 (2 REQUIRED) WIDE TRACK FRONT AXLE STABILIZER SHOCK PART NUMBER: 66515 (2 REQUIRED)

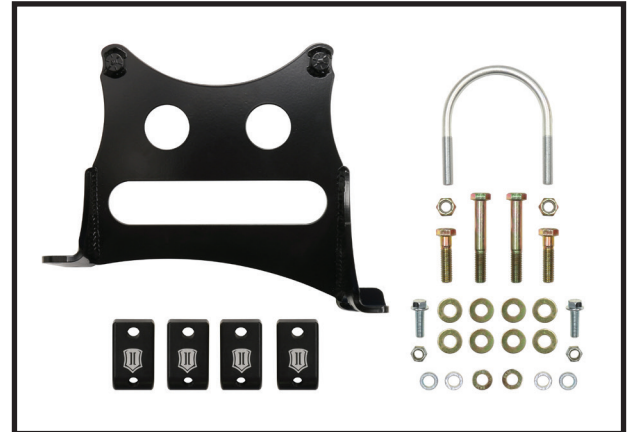

WARNING!

**** READ ALL INSTRUCTIONS THOROUGHLY FROM START TO FINISH BEFORE BEGINNING INSTALLATION! IF THESE INSTRUCTIONS ARE NOT PROPERLY FOLLOWED SEVERE FRAME, SUSPENSION AND TIRE DAMAGE MAY RESULT TO THE VEHICLE!**

**** ICON VEHICLE DYNAMICS RECOMMENDS THAT YOU EXERCISE EXTREME CAUTION WHEN WORKING UNDER A VEHICLE THAT IS SUPPORTED WITH JACK STANDS.**

**** ICON VEHICLE DYNAMICS RECOMMENDS ALL INSTALLATION TO BE PERFORMED BY A PROFESSIONAL SHOP/SERVICE TECHNICIAN. PRODUCT FAILURE CAUSED BY IMPROPER INSTALLATION WILL NOT BE COVERED UNDER ICON'S WARRANTY POLICY.**

INSTALLATION

1. ENSURE TRUCK IS IN GEAR OR IN PARK, SET PARKING BRAKE, TURN OFF ENGINE, AND CHOCK TIRES.
2. Using an 18mm, disconnect the factory steering stabilizer from the drag link. Hammer the tapered end out of the drag link, then use a 15mm to remove the bolt holding it to the frame bracket.
3. Install the center bracket: This bracket attaches to (2) front differential cover bolts; this will require moving a tag on the differential. Use a 15mm to remove the (2) bolts. After removing the tag, install the bracket using the stand off spacers between bracket and cover. If desired, the tag can be placed in front of the bracket. Replace the (2) factory bolts with the supplied 3/8" flanged bolts. [Torque to 33 ft-lbs]. Use the 7/16" U-bolt to clamp the bracket around the axle housing. Install the U-bolt facing downward using the supplied 7/16" lock nuts and washers. [Torque to 47 ft-lbs]
4. Install the billet aluminum clamp on the driver side tie rod end with the shield facing out and within 1/8" from the flat side of the tie rod. Place the clamp between the adjuster and the bend in the tie rod. Install the 1/2x2" long bolts through the bottom hole of the rear clamp into the threaded hole on the front clamp. Repeat process on passenger side. [FIGURE 1 & 2]

FIG.1

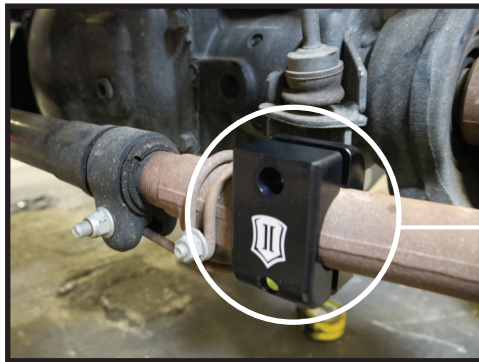
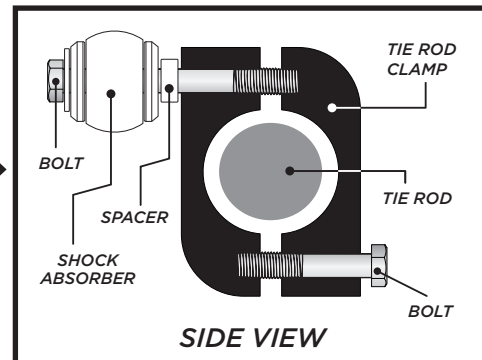

FIG.2



5. If installing steering stabilizers on a wide track axle Super Duty, you must mount the shocks with the bodies pointing towards the wheels (unless 64036 spacer kit is used). Use the supplied 1/2x3.5" bolt making sure to install the supplied washers on both sides of the shock sleeve. Use the (169003) spacer between the washer and billet clamp. If you do not have a wide track axle, you can mount the stabilizers in either direction. [Torque to 75 ft-lbs] alternating between the top and bottom bolt to make sure the gap is equal on both sides of the clamp.

6. Mount the free end of the shock to the center mount stud with the supplied nut and washer. [Torque to 75 ft-lbs]

VERIFY ALL FASTENERS ARE PROPERLY TORQUED BEFORE DRIVING VEHICLE.

RETORQUE ALL NUTS, BOLTS AND LUGS AFTER 100 MILES AND PERIODICALLY THEREAFTER.



ICON VEHICLE DYNAMICS LIMITED LIFETIME WARRANTY

ICON Vehicle Dynamics warrants to the original retail purchaser who owns the vehicle on which the product was originally installed. ICON Vehicle Dynamics does not warrant the product for finish, alterations, modifications and/or installation contrary to ICON Vehicle Dynamics instructions. ICON Vehicle Dynamics products are not designed, nor are they intended to be installed on vehicles used in race applications, for racing purposes or for similar activities. (A "race" is defined as any contest between two or more vehicles, or a contest of one or more vehicles against the clock, whether or not such contest is for a prize). This warranty does not include coverage for police or taxi vehicles, race vehicles, or vehicles used for government or commercial purposes. Also excluded from this warranty are sales outside of the United States of America and Canada.

ICON Vehicle Dynamics' obligation under this warranty is limited to the repair or replacement, at ICON Vehicle Dynamics' discretion, of the defective product. Any and all costs of removal, installation or re-installation, freight charges and incidental or consequential damages are expressly excluded from this warranty. Items that are subject to wear are not considered defective when worn and are not covered.

ICON Vehicle Dynamics components must be installed as a complete kit as shown in our current application guide. Any substitutions or exemptions of required components will immediately void the warranty. Some finish damage may happen to parts during shipping and is not covered under warranty.

This warranty is expressly in lieu of all other warranties expressed or implied. This warranty shall not apply to any product that has been improperly installed, modified or customized subject to accident, negligence, abuse or misuse.



ICON VEHICLE DYNAMICS®
PERFORMANCE SUSPENSION SYSTEMS AND SHOCK ABSORBERS

7929 Lincoln Ave. Riverside, CA 92504 Phone: 951.689.ICON Fax: 951.689.1016
www.iconvehicledynamics.com



FOLLOW US ON FACEBOOK!



7929 Lincoln Ave. Riverside, CA 92504
Phone: 951.689.ICON | Fax: 951.689.1016

PART #	DESCRIPTION
67800CP	05-UP FSD 4WD 0-2.5" FRONT 2.5 VS RR CDCV PAIR

COMPONENTS INCLUDED	
(2) 164941C 05+ FSD 0-2.5" FRONT RR CDCV (2) 160085 05+ FSD RESI MT COIL BUCKET	(2) 611006 9/16" HD STEM BUSHING KIT (1) 611051 #40 2 1/16-3" HOSE CLAMP KIT
HARDWARE INCLUDED	
(2) 605144 3/8-12 X .750 FLANGED SELF TAP BOLT	
611006 HARDWARE KIT	
(2) HEAVY DUTY 9/16 ID STEM BUSHING (1) HEAVY DUTY 9/16 ID STEM WASHER	(1) HEAVY DUTY 12MM ID STEM WASHER (1) M12-1.25 NUT (1) M12-1.25 JAM NUT
611051 HARDWARE KIT	
(4) 605931 1/2 X 2 1/16-3 ID #40 SS HOSE CLAMP	
TOOLS REQUIRED	
JACK JACK STANDS PLIERS DRILL 11/32" DRILL BIT	TORQUE WRENCH 5/16" SOCKET / WRENCH 9/16" SOCKET / WRENCH 17MM SOCKET / WRENCH 18MM SOCKET / WRENCH 19MM SOCKET / WRENCH
TECH NOTES	
1. YOUR ICON SHOCK ASSEMBLIES COME FACTORY CHARGED TO 150 PSI. RELEASING NITROGEN PRESSURE MAY LEAD TO SHOCK MALFUNCTION AND REDUCED RIDE QUALITY. FAILURE CAUSED BY LOW NITROGEN PRESSURE IS NOT COVERED UNDER ICON'S WARRANTY POLICY.	



WARNING!
** READ ALL INSTRUCTIONS THOROUGHLY FROM START TO FINISH BEFORE BEGINNING INSTALLATION! IF THESE INSTRUCTIONS ARE NOT PROPERLY FOLLOWED SEVERE FRAME, SUSPENSION AND TIRE DAMAGE MAY RESULT TO THE VEHICLE!
** ICON VEHICLE DYNAMICS RECOMMENDS THAT YOU EXERCISE EXTREME CAUTION WHEN WORKING UNDER A VEHICLE THAT IS SUPPORTED WITH JACK STANDS.
** ICON VEHICLE DYNAMICS RECOMMENDS ALL INSTALLATION TO BE PERFORMED BY A PROFESSIONAL SHOP/SERVICE TECHNICIAN. PRODUCT FAILURE CAUSED BY IMPROPER INSTALLATION WILL NOT BE COVERED UNDER ICON'S WARRANTY POLICY.

INSTALLATION

- Using a properly rated jack, raise the front of the vehicle and support the frame rails with jack stands. Ensure the jack stands are secure and set properly before lowering the jack. NEVER WORK UNDER AN UNSUPPORTED VEHICLE. Remove the front wheels.
- Remove the sway bar links from the sway bar using an 18mm socket/wrench. Leave them connected to the differential. [FIGURE 1]

FIG.1

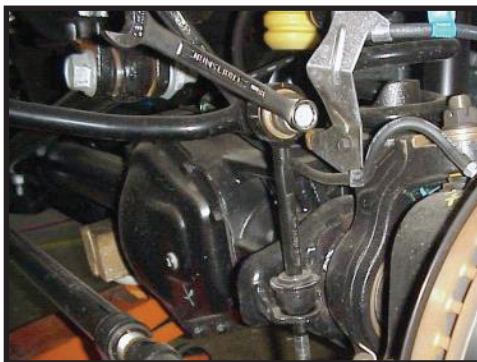

FIG.2



- Disconnect the upper brake line brackets from the frame using a 13mm socket/wrench and lower brake line brackets from the differential using a 10mm socket/wrench. [FIGURE 2]

4. On the driver side of the track bar, remove the nut and the upper track bar bolt using (2) 30mm socket/wrenches. [FIGURE 3]

FIG.3

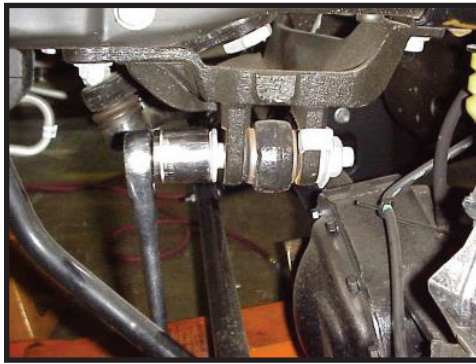

5. Use a jack to support the axle and then remove the factory shock using a 17mm and 18mm socket/wrench.
6. Slowly lower the axle, the coils will unload from the mounts and can be removed. Be careful not to stretch or damage any lines connected to the axle or radius arms.
7. Lower the axle enough to install the reservoir mount between the coil bucket and the coil isolator.
8. Raise the axle using a floor jack
9. Install stem hardware as seen in diagram. Install (605810) tall nut and fasten bushing assembly until 3-4 threads are exposed for the (605809) jam nut. Install (605809) nut and torque to 50 ft-lbs while holding (605810) with a 19mm wrench. Do not overtighten bushing assembly as this can lead to premature bushing wear. Failure caused by incorrect installation of bushings is not covered under ICON's warranty policy. Install the wide heim spacer so that it orients the shock further away from the frame and then install the factory lower bolt using an 18mm socket/wrench. [Torque to factory spec] [SEE DIAGRAM]

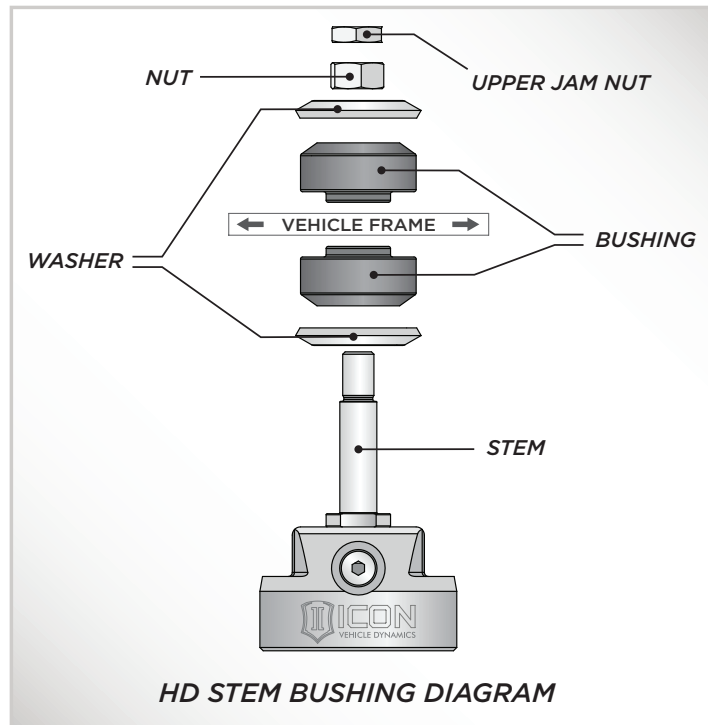

10. Connect the shock to the lower shock mount using a 17mm/18mm socket/wrench.

11. Mount the reservoir to the bracket using a 5/16" nut driver and the supplied (605931) hose clamps. **[FIGURE 4]**

FIG.4



12. If installing coilover conversion, use the doubler reservoir mount (supplied in coilover kit) for mounting both reservoirs as shown. **[FIGURE 5]**

FIG.4



13. Connect the sway bar links to the sway bar using an 18mm socket/wrench. [Torque to factory spec]

14. Reconnect the upper brake line bracket to the frame using a 13mm socket/wrench and the lower bracket using a 10mm socket/wrench [Torque to factory spec]. Depending on the year of the truck, the brake line may need to be manipulated down to not overextend at full droop.

15. Reconnect the track bar using (2) 30mm socket/wrenches. [Torque to factory spec]

16. Install wheels and lower vehicle to the ground. [Torque lugs to factory spec]

17. Have the vehicle professionally aligned.

VERIFY ALL FASTENERS ARE PROPERLY TORQUED BEFORE DRIVING VEHICLE.

RETORQUE ALL NUTS, BOLTS AND LUGS AFTER 100 MILES AND PERIODICALLY THEREAFTER.

2.5 VS SERIES SHOCK & COILOVER TECHNICAL INFORMATION

MAINTENANCE

ICON shock absorbers are a high quality rebuildable race style shock absorber designed for optimal performance. With a unit of this caliber on your vehicle, routine maintenance is required to keep them looking and operating in like new condition. Residual oil and assembly lube may be present at all seal paths from the factory out of the box and is considered normal. Pooling of oil however is not acceptable at any time and one should contact the ICON dealer where purchased.

BELOW ARE GUIDELINES BASED ON HOW YOU USE YOUR VEHICLE BUT YOUR MILEAGE MAY VARY:

STREET USE:

- Send in for factory servicing every 40,000 miles or if a leak develops, ride quality decreases, or they begin to make excessive noise.
- Remove any buildup of road salt, mud, or debris from shocks and coil springs anytime accrued
- Clean with mild soap and water with each oil change or anytime you notice build up.
- Wax the cylinders yearly with automotive wax to prevent corrosion.
- Check nitrogen pressure yearly. (252004 charge needle assembly available at any ICON distributor)
- Check bearings for excessive wear yearly.
- DO NOT apply any type of lube to the upper and lower bearings.

STREET/DIRT:

- Send in for factory servicing every 15,000 miles or if a leak develops, ride quality decreases, or they begin to make excessive noise.
- Clean with mild soap and water with each oil change, offroad trip, or anytime you notice build up.
- Wax the cylinders yearly with automotive wax to prevent corrosion.
- Check nitrogen pressure each dirt outing. (252004 charge needle assembly available at any ICON distributor)
- Check bearings for excessive wear yearly.
- DO NOT apply any type of lube to the upper and lower bearings.

DIRT USE:

- Send in for factory servicing every 1,000 miles.
- Check nitrogen pressure each outing. (252004 charge needle assembly available at any ICON distributor)
- Remove any buildup of mud or debris from shocks and coil springs after every outing.

SELF-SERVICE:

- Contact ICON for service kits & tools at (951) 689-4266.

PRODUCT REGISTRATION

Please visit: <http://www.iconvehicledynamics.com/tech-support/registration/> to register your product.

ICON VEHICLE DYNAMICS SHOCK ABSORBER WARRANTY

This shock absorber has a 1 year warranty against any manufacturer's defects. If a shock fails within the initial year of ownership, the shock must be shipped to ICON Vehicle Dynamics for inspection and service. If a shock is inspected and it has been determined the shock failed due to neglect, damage caused by improper installation or any other reason besides "normal wear and tear", the owner of said shock is responsible for all service costs. This includes labor, parts, and shipping.

ICON Vehicle Dynamics warrants to the original retail purchaser who owns the vehicle on which the product was originally installed. ICON Vehicle Dynamics does not warrant the product for finish, alterations, modifications and/or installation contrary to ICON Vehicle Dynamics instructions. ICON Vehicle Dynamics products are not designed, nor are they intended to be installed on vehicles used in race applications, for racing purposes or for similar activities. (A "race" is defined as any contest between two or more vehicles, or a contest of one or more vehicles against the clock, whether or not such contest is for a prize). This warranty does not include coverage for police or taxi vehicles, race vehicles, or vehicles used for government or commercial purposes. Also excluded from this warranty are sales outside of the United States of America and Canada.

ICON Vehicle Dynamics' obligation under this warranty is limited to the repair or replacement, at ICON Vehicle Dynamics' discretion, of the defective product. Any and all costs of removal, installation or re-installation, freight charges and incidental or consequential damages are expressly excluded from this warranty. Items that are subject to wear are not considered defective when worn and are not covered.

ICON Vehicle Dynamics components must be installed as a complete kit as shown in our current application guide. Any substitutions or exemptions of required components will immediately void the warranty. Some finish damage may happen to parts during shipping and is not covered under warranty.

This warranty is expressly in lieu of all other warranties expressed or implied. This warranty shall not apply to any product that has been improperly installed, modified or customized subject to accident, negligence, abuse or misuse.

To send a shock in for warranty please visit our website <http://www.iconvehicledynamics.com/tech-support/shock-service/>



ICON VEHICLE DYNAMICS®
PERFORMANCE SUSPENSION SYSTEMS AND SHOCK ABSORBERS

7929 Lincoln Ave. Riverside, CA 92504 Phone: 951.689.ICON Fax: 951.689.1016
www.iconvehicledynamics.com



FOLLOW US ON FACEBOOK!

