

7929 Lincoln Ave. Riverside, CA 92504  
 Phone: 951.689.ICON Fax: 951.689.1016

PART #	DESCRIPTION
64010	05-UP FSD FRONT 4.5 DUAL RATE COIL KIT

COMPONENTS INCLUDED	
(2) 168501 05+ FSD 4.5 DUAL RATE COIL SPRING	
HARDWARE INCLUDED	
N/A	
TOOLS REQUIRED	
JACK JACK STANDS PLIERS TORQUE WRENCH HAMMER BALL JOINT SEPARATOR	3/4" SOCKET / WRENCH 10MM SOCKET / WRENCH 13MM SOCKET / WRENCH 18MM SOCKET / WRENCH 21MM SOCKET / WRENCH 30MM SOCKET / WRENCH
TECH NOTES	
<p>1. LIFT HEIGHTS ARE BASED ON CREW CAB DIESEL F-250 CONFIGURATIONS.</p> <p>2. ICON 4.5" COIL SPRINGS MUST BE INSTALLED IN CONJUNCTION WITH AN ICON 4.5" RADIUS ARM OR 4-LINK KIT.</p>	



**WARNING!**

**\*\* READ ALL INSTRUCTIONS THOROUGHLY FROM START TO FINISH BEFORE BEGINNING INSTALLATION! IF THESE INSTRUCTIONS ARE NOT PROPERLY FOLLOWED SEVERE FRAME, SUSPENSION AND TIRE DAMAGE MAY RESULT TO THE VEHICLE!**

**\*\* ICON VEHICLE DYNAMICS RECOMMENDS THAT YOU EXERCISE EXTREME CAUTION WHEN WORKING UNDER A VEHICLE THAT IS SUPPORTED WITH JACK STANDS.**

**\*\* ICON VEHICLE DYNAMICS RECOMMENDS ALL INSTALLTION TO BE PERFORMED BY A PROFESSIONAL SHOP/SERVICE TECHNICIAN. PRODUCT FAILURE CAUSED BY IMPROPER INSTALLATION WILL NOT BE COVERED UNDER ICON'S WARRANTY POLICY.**

## INSTALLATION

- Using a properly rated jack, raise the front of the vehicle and support the frame rails with jack stands. Ensure the jack stands are secure and set properly before lowering the jack. NEVER WORK UNDER AN UNSUPPORTED VEHICLE. Remove front wheels.
- Remove the sway bar links from the sway bar using an 18mm socket/wrench. Leave them connected to the differential. [FIGURE 1]

FIG.1

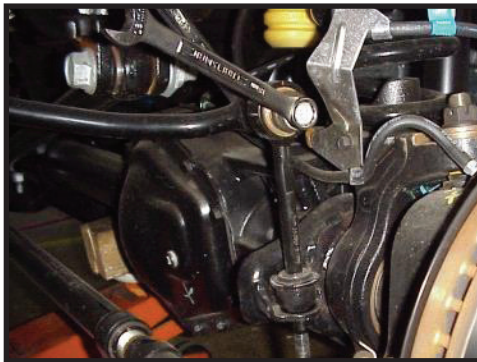

FIG.2



- Disconnect the upper brake line brackets from the frame using a 13mm socket/wrench and lower brake line brackets from the differential using a 10mm socket/wrench. [FIGURE 2]

- 4.** On the driver side of the track bar, remove the nut and the upper track bar bolt using (2) 30mm socket/wrenches. [FIGURE 3]

**FIG.3**

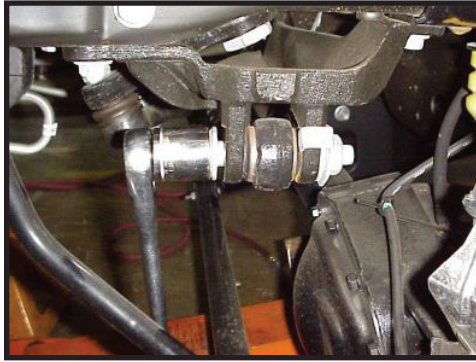

- 5.** Support the axle with a floor jack and remove the front shocks. The shocks are limiting droop so make sure that the axle is supported or it will fall when the shocks are removed. (21mm socket/wrench, 18mm socket/wrench)
- 6.** Slowly lower the axle, the coils will unload from the mounts and can be removed. Be careful not to stretch or damage any lines connected to the axle or radius arms. On 2017-UP models, removing the drag link from the pitman arm may be required.
- 7.** Lower the axle just enough to install the new springs. Place the original rubber isolator on top of the new coil and install. Be careful to not stretch or damage any lines. Check the rotation/clocking of the coil to make sure it is properly seated in the lower spring perch.
- 8.** Lift the axle high enough to connect the shocks but be careful not to lift the truck off of its supports. Use the original bolt on the lower shock mount and tighten with an 18mm socket/wrench [Torque to factory spec]. Tighten the stem top nut using a 3/4" socket/wrench. (Refer to shock instructions)
- 9.** Connect the sway bar links to the sway bar using an 18mm socket/wrench. [Torque to factory spec]
- 10.** Reconnect the upper brake line bracket to the frame using a 13mm socket/wrench and the lower bracket using a 10mm socket/wrench [Torque to factory spec]. Depending on the year of the truck, the brake line may need to be manipulated down to not overextend at full droop.
- 11.** Reconnect the track bar using (2) 30mm socket/wrenches [Torque to factory spec]. If drag link was removed in step 6, lift axle to ride height and reinstall. [Torque to factory spec]
- 12.** Install the wheels and lower the vehicle to the ground.
- 13.** Have the vehicle professionally aligned.

***VERIFY ALL FASTENERS ARE PROPERLY TORQUED BEFORE DRIVING VEHICLE.***

***RETORQUE ALL NUTS, BOLTS AND LUGS AFTER 100 MILES AND PERIODICALLY THEREAFTER.***

## ICON VEHICLE DYNAMICS LIMITED LIFETIME WARRANTY

ICON Vehicle Dynamics warrants to the original retail purchaser who owns the vehicle on which the product was originally installed. ICON Vehicle Dynamics does not warrant the product for finish, alterations, modifications and/or installation contrary to ICON Vehicle Dynamics instructions. ICON Vehicle Dynamics products are not designed, nor are they intended to be installed on vehicles used in race applications, for racing purposes or for similar activities. (A "race" is defined as any contest between two or more vehicles, or a contest of one or more vehicles against the clock, whether or not such contest is for a prize). This warranty does not include coverage for police or taxi vehicles, race vehicles, or vehicles used for government or commercial purposes. Also excluded from this warranty are sales outside of the United States of America and Canada.

ICON Vehicle Dynamics' obligation under this warranty is limited to the repair or replacement, at ICON Vehicle Dynamics' discretion, of the defective product. Any and all costs of removal, installation or re-installation, freight charges and incidental or consequential damages are expressly excluded from this warranty. Items that are subject to wear are not considered defective when worn and are not covered.

ICON Vehicle Dynamics components must be installed as a complete kit as shown in our current application guide. Any substitutions or exemptions of required components will immediately void the warranty. Some finish damage may happen to parts during shipping and is not covered under warranty.

This warranty is expressly in lieu of all other warranties expressed or implied. This warranty shall not apply to any product that has been improperly installed, modified or customized subject to accident, negligence, abuse or misuse.

# ICON VEHICLE DYNAMICS

PERFORMANCE SUSPENSION SYSTEMS AND SHOCK ABSORBERS

7929 Lincoln Ave. Riverside, CA 92504 Phone: 951.689.ICON Fax: 951.689.1016  
[www.iconvehicledynamics.com](http://www.iconvehicledynamics.com)



FOLLOW US ON FACEBOOK!



7929 Lincoln Ave. Riverside, CA 92504  
Phone: 951.689.ICON Fax: 951.689.1016

PART #	DESCRIPTION
64038	2017-UP FSD ADJUSTABLE TRACK BAR KIT

COMPONENTS INCLUDED	
(1) 164037 2017-UP FSD ADJUSTABLE TRACK BAR (2) 167021 HEIM SPACER JM16 X .812 X 1.750 (1) 167027 LEFT/RIGHT ADJUSTER ROUND (1) 168001 05-UP TRACK BAR BALL JOINT W/NUT	(1) 295513 JM16-1T, 1-14 LH ROD END F1 FIT (2) 605145 3/8-16 X 1.000 12PT SCREW (1) 605951 SPIRAL RETAINING RING
HARDWARE INCLUDED	
N/A	
TOOLS REQUIRED	
TAPE MEASURE BALL JOINT SEPARATOR HAMMER 1/4" SPANNER WRENCH TORQUE WRENCH	3/8" 12PT SOCKET / WRENCH 13MM SOCKET / WRENCH 27MM SOCKET / WRENCH 30MM SOCKET / WRENCH (2)
TECH NOTES	
1. DO NOT EXCEED 3.375" OF ADJUSTMENT FROM THE CENTER OF THE ROD END TO THE EDGE OF THE TRACK BAR PINCH HOUSING. FAILURE CAUSED BY EXCESSIVE ADJUSTMENT WILL NOT BE COVERED UNDER ICON'S WARRANTY POLICY.	



WARNING!
** READ ALL INSTRUCTIONS THOROUGHLY FROM START TO FINISH BEFORE BEGINNING INSTALLATION! IF THESE INSTRUCTIONS ARE NOT PROPERLY FOLLOWED SEVERE FRAME, SUSPENSION AND TIRE DAMAGE MAY RESULT TO THE VEHICLE!
** ICON VEHICLE DYNAMICS RECOMMENDS THAT YOU EXERCISE EXTREME CAUTION WHEN WORKING UNDER A VEHICLE THAT IS SUPPORTED WITH JACK STANDS.
** ICON VEHICLE DYNAMICS RECOMMENDS ALL INSTALLTION TO BE PERFORMED BY A PROFESSIONAL SHOP/SERVICE TECHNICIAN. PRODUCT FAILURE CAUSED BY IMPROPER INSTALLATION WILL NOT BE COVERED UNDER ICON'S WARRANTY POLICY.

## INSTALLATION

1. Remove the stock track bar from the frame bracket using (2) 30mm sockets/wrenches. The vehicle may shift slightly.
2. Remove the track bar from the ball joint taper on the axle. Using a 27mm, remove the nut and separate the ball joint using a ball joint separator and hammer.
3. Connect the ICON track bar to the axle. Use a 13mm to keep the tapered stud from spinning while tightening the nut with a 27mm socket/wrench. [Torque to factory spec] [FIGURE 1]

FIG.1



4. Loosen the pinch bolts using a 3/8" 12pt socket/wrench.
5. Adjust the collar of the track bar while keeping the threaded bushing housing from spinning. Adjust as needed to line up in the frame bracket.

6. Install the factory upper track bar bolt using (2) 30mm sockets/wrenches. [Torque to 406 ft-lbs] [FIGURE 2]

FIG.2



**NOTE:** This track bar is adjustable from 36.75" - 37.75". The stock track bar measures 36.625" from eye to eye.

7. Adjust the collar to center the axle under the frame. Do not exceed the maximum adjustment range as outlined in the tech notes.

8. Tighten the pinch bolts using an alternating pattern and a 3/8" 12pt socket/wrench. [Torque to 35 ft-lbs]

9. Use the drag link adjustment to center the steering wheel before driving.

10. Have the vehicle professionally aligned.

***VERIFY ALL FASTENERS ARE PROPERLY TORQUED BEFORE DRIVING VEHICLE.***

***RETORQUE ALL NUTS, BOLTS AND LUGS AFTER 100 MILES AND PERIODICALLY THEREAFTER.***

### ***ICON VEHICLE DYNAMICS LIMITED LIFETIME WARRANTY***

ICON Vehicle Dynamics warrants to the original retail purchaser who owns the vehicle on which the product was originally installed. ICON Vehicle Dynamics does not warrant the product for finish, alterations, modifications and/or installation contrary to ICON Vehicle Dynamics instructions. ICON Vehicle Dynamics products are not designed, nor are they intended to be installed on vehicles used in race applications, for racing purposes or for similar activities. (A "race" is defined as any contest between two or more vehicles, or a contest of one or more vehicles against the clock, whether or not such contest is for a prize). This warranty does not include coverage for police or taxi vehicles, race vehicles, or vehicles used for government or commercial purposes. Also excluded from this warranty are sales outside of the United States of America and Canada.

ICON Vehicle Dynamics' obligation under this warranty is limited to the repair or replacement, at ICON Vehicle Dynamics' discretion, of the defective product. Any and all costs of removal, installation or re-installation, freight charges and incidental or consequential damages are expressly excluded from this warranty. Items that are subject to wear are not considered defective when worn and are not covered.

ICON Vehicle Dynamics components must be installed as a complete kit as shown in our current application guide. Any substitutions or exemptions of required components will immediately void the warranty. Some finish damage may happen to parts during shipping and is not covered under warranty.

This warranty is expressly in lieu of all other warranties expressed or implied. This warranty shall not apply to any product that has been improperly installed, modified or customized subject to accident, negligence, abuse or misuse.

## **ICON VEHICLE DYNAMICS**

PERFORMANCE SUSPENSION SYSTEMS AND SHOCK ABSORBERS

7929 Lincoln Ave. Riverside, CA 92504 Phone: 951.689.ICON Fax: 951.689.1016  
www.iconvehicledynamics.com



**FOLLOW US ON FACEBOOK!**



7929 Lincoln Ave. Riverside, CA 92504  
Phone: 951.689.ICON | Fax: 951.689.1016

PART #	DESCRIPTION
64050	2008-UP FSD FRONT 4.5 BOX KIT

COMPONENTS INCLUDED	
(2) 164003 05-UP FSD UPPER BRAKE LINE DROP BRACKET (2) 164018 08-UP FSD SWAY BAR DROP BRACKET	(2) 167004 05-UP FSD FRONT BUMPTOP SPACER (1) 64050H HARDWARE KIT
HARDWARE INCLUDED	
64050H HARDWARE KIT	
(2) 605011 5/16-18 X .750 BOLT (2) 605012 5/16 SPLIT LOCK WASHER (4) 605101 3/8-16 X 1.000 BOLT	(4) 605133 3/8" FLAT WASHER (2) 605803 M8-1.25 X 70MM BOLT
TOOLS REQUIRED	
JACK JACK STANDS BRASS HAMMER STEEL HAMMER CUTTING WHEEL PAINT TORQUE WRENCH 3/8" SOCKET / WRENCH 1/2" SOCKET / WRENCH 5/8" SOCKET / WRENCH	3/4" SOCKET / WRENCH 15/16" SOCKET / WRENCH 10MM SOCKET / WRENCH 13MM SOCKET / WRENCH 15MM SOCKET / WRENCH 16MM SOCKET / WRENCH 18MM SOCKET / WRENCH 21MM SOCKET / WRENCH 24MM SOCKET / WRENCH 30MM SOCKET / WRENCH
TECH NOTES	
<p><b>REQUIRED KITS:</b></p> <p>ICON 4-LINK KIT PN: (61500 2005-2010) (61550 2011-16) (61560 2017-UP) OR ICON RADIUS ARM DROP KIT PN: (64040 2005-2010) (64045 2011-16) (64055 2017-UP)</p>	



**WARNING!**

**\*\* READ ALL INSTRUCTIONS THOROUGHLY FROM START TO FINISH BEFORE BEGINNING INSTALLATION! IF THESE INSTRUCTIONS ARE NOT PROPERLY FOLLOWED SEVERE FRAME, SUSPENSION AND TIRE DAMAGE MAY RESULT TO THE VEHICLE!**

**\*\* ICON VEHICLE DYNAMICS RECOMMENDS THAT YOU EXERCISE EXTREME CAUTION WHEN WORKING UNDER A VEHICLE THAT IS SUPPORTED WITH JACK STANDS.**

**\*\* ICON VEHICLE DYNAMICS RECOMMENDS ALL INSTALLATION TO BE PERFORMED BY A PROFESSIONAL SHOP/SERVICE TECHNICIAN. PRODUCT FAILURE CAUSED BY IMPROPER INSTALLATION WILL NOT BE COVERED UNDER ICON'S WARRANTY POLICY.**

**INSTALLATION**

- Using a properly rated jack, raise the front of the vehicle and support the frame rails with jack stands. Ensure the jack stands are secure and set properly before lowering the jack. NEVER WORK UNDER AN UNSUPPORTED VEHICLE. Remove front wheels.
- Remove the sway bar links from the sway bar using an 18mm socket/wrench. Leave them connected to the differential. [FIGURE 1]

FIG.1

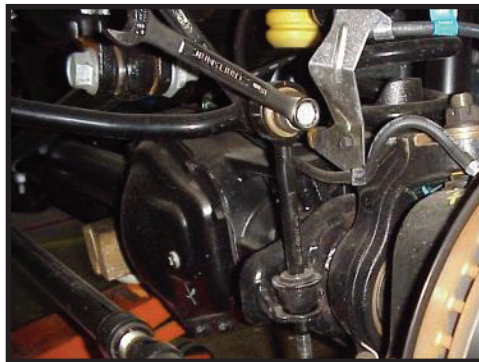

FIG.2



- Disconnect the upper brake line brackets from the frame using a 13mm socket/wrench and lower brake line brackets from the differential using a 10mm socket/wrench. [FIGURE 2]

- 4.** On the driver side of the track bar, remove the nut and the upper track bar bolt using two 30mm socket/wrenches. [FIGURE 3]

**FIG.3**

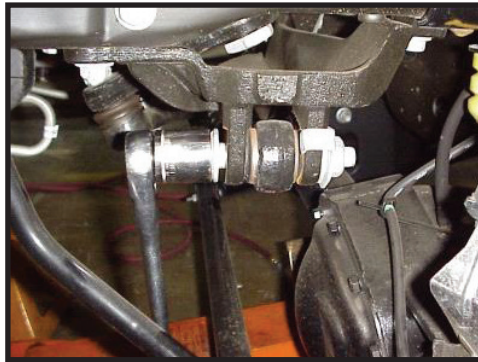

- 5.** Support the axle with a floor jack and remove the front shocks. The shocks are limiting droop so make sure that the axle is supported or it will fall when the shocks are removed. (21mm socket/wrench, 18mm socket/wrench)
- 6.** Slowly lower the axle, the coils will unload from the mounts and can be removed. Be careful not to stretch or damage any lines connected to the axle or radius arms.
- 7.** Refer to 4-Link instructions (61500 2005-2010), (61550 2011-2016), (61560 2017-UP) and/or radius arm kit (64040 2005-2010), (64045 2011-2016), (64055 2017-UP) and install now.
- 8.** Lower the axle just enough to install the new springs. Place the original rubber isolator on top of the new coil and install. Be careful to not stretch or damage any lines. Check the rotation/clocking of the coil to make sure it is properly seated in the lower spring perch.
- 9.** Lift the axle high enough to connect the shocks but be careful not to lift the truck off of its supports. Use the original bolt on the lower shock mount and tighten with an 18mm socket/wrench [Torque to factory spec]. Tighten the stem top nut using a 3/4" socket/wrench. (Refer to shock instructions)
- 10.** Slowly lower the axle after the shocks are installed.
- 11.** If an ICON adjustable track bar (64031 or 64038) was purchased, refer to track bar installation instructions.
- 12.** Reconnect the track bar to the frame bracket using the factory hardware and (2) 30mm. You may have to raise or lower the axle to help line up the holes. [Torque to factory spec]
- 13.** Pry the front bump stops out of the bump stop cup. Remove the bolt in the center of the cup using a 10mm. Install the bump stop spacer between the cup and the frame with the supplied bolt. The cup has a flat side on its outer flange. Rotate the flat side to be near the coil for added clearance. [Torque to factory spec] [FIGURE 4]

**FIG.4**



- 14.** Push the bump stops back into the cups until they should clip/pop into place.
- 15.** Remove the sway bar from the frame using a 13mm.
- 16.** If needed, some trucks require cutting the sway bar studs shorter. Using a cutting wheel, cut 3/8" off the end of the stud. Sand the edges to remove any burrs and paint exposed metal.
- 17.** Install sway bar drop brackets (164018) using the factory hardware and a 13mm. [Torque to factory spec]

**18.** Using 3/8" hardware and a 9/16" socket/wrench, install the (164018) sway bar drop brackets. [Torque to 33 ft-lbs] [FIGURE 5]

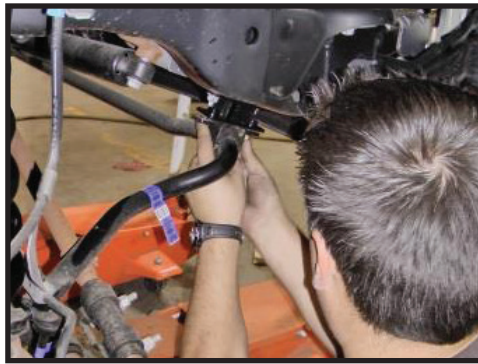

**FIG.5**

**19.** Reconnect the sway bar to the stock links using an 18mm. [Torque to factory spec]

**20.** Install the upper brake line brackets using the factory bolts. This bracket uses the factory bolt on the top and a supplied 5/16" bolt on the bottom. Using (2) 1/2" wrenches to tighten [Torque to 19 ft-lbs]. Carefully bend and reroute the hard line. 2005-2010 [FIGURE 6] 2011-UP [FIGURE 7]



**FIG.6**



**FIG.7**

**21.** If an ICON dual steering stabilizer kit (PN: 65000) has been purchased, refer to steering stabilizer instructions and install now.

**22.** Reinstall wheels and lower the vehicle to the ground. [Torque to factory spec]

**23.** Have the vehicle professionally aligned.

***VERIFY ALL FASTENERS ARE PROPERLY TORQUED BEFORE DRIVING VEHICLE.***

***RETORQUE ALL NUTS, BOLTS AND LUGS AFTER 100 MILES AND PERIODICALLY THEREAFTER.***

### ***ICON VEHICLE DYNAMICS LIMITED LIFETIME WARRANTY***

ICON Vehicle Dynamics warrants to the original retail purchaser who owns the vehicle on which the product was originally installed. ICON Vehicle Dynamics does not warrant the product for finish, alterations, modifications and/or installation contrary to ICON Vehicle Dynamics instructions. ICON Vehicle Dynamics products are not designed, nor are they intended to be installed on vehicles used in race applications, for racing purposes or for similar activities. (A "race" is defined as any contest between two or more vehicles, or a contest of one or more vehicles against the clock, whether or not such contest is for a prize). This warranty does not include coverage for police or taxi vehicles, race vehicles, or vehicles used for government or commercial purposes. Also excluded from this warranty are sales outside of the United States of America and Canada.

ICON Vehicle Dynamics' obligation under this warranty is limited to the repair or replacement, at ICON Vehicle Dynamics' discretion, of the defective product. Any and all costs of removal, installation or re-installation, freight charges and incidental or consequential damages are expressly excluded from this warranty. Items that are subject to wear are not considered defective when worn and are not covered.

ICON Vehicle Dynamics components must be installed as a complete kit as shown in our current application guide. Any substitutions or exemptions of required components will immediately void the warranty. Some finish damage may happen to parts during shipping and is not covered under warranty.

This warranty is expressly in lieu of all other warranties expressed or implied. This warranty shall not apply to any product that has been improperly installed, modified or customized subject to accident, negligence, abuse or misuse.

7929 Lincoln Ave. Riverside, CA 92504  
Phone: 951.689.ICON Fax: 951.689.1016

PART #	DESCRIPTION
64055	2017-UP FSD RADIUS ARM DROP KIT

### COMPONENTS INCLUDED

(1) 164038 17-UP FSD RADIUS ARM DROP (DRVR)	(1) 64055H 17-UP FSD RADIUS ARM DROP
(1) 164039 17-UP FSD RADIUS ARM DROP (PASS)	HARDWARE KIT

### HARDWARE INCLUDED

#### 64055H HARDWARE KIT

(1) 164042 17+ FSD FRAME NUT PLATE (DRVR)	(2) 605601 3/4-10 X 5.500 BOLT
(1) 164043 17+ FSD FRAME NUT PLATE (PASS)	(2) 605620 3/4-10 NYLOCK NUT
(4) 167029 SPACER 1.500 X .525 X .625	(4) 605630 3/4" FLAT WASHER
(1) 294008 WASHER 2.25 X .650 X .250	(2) 605821 M18-2.5 NYLOCK NUT
(4) 605230 7/16" FLAT WASHER	(2) 605823 M12-1.75 NYLOCK NUT
(8) 605357 WASHER 1.50 X .531 X .042-51	(2) 605831 M18 X 139.3 OAL OEM FORD BOLT
(2) 605518 5/8-11 X 1.500 BOLT	(2) 605832 M18 FLAT WASHER
(2) 605527 5/8" SPLIT LOCK WASHER	(2) 605849 M12-1.75 X 180MM BOLT

### TOOLS REQUIRED

JACK	8MM SOCKET / WRENCH
JACK STANDS	10MM SOCKET / WRENCH
TORQUE WRENCH	13MM SOCKET / WRENCH
3/8" 12PT SOCKET / WRENCH	15MM SOCKET / WRENCH
1/2" SOCKET / WRENCH	18MM SOCKET / WRENCH
15/16" SOCKET / WRENCH	19MM SOCKET / WRENCH
11/16" SOCKET / WRENCH	24MM SOCKET / WRENCH
11/8" SOCKET / WRENCH	27MM SOCKET / WRENCH
	30MM SOCKET / WRENCH

### TECH NOTES

- RADIUS ARM KIT INTENDED FOR USE WITH 4.5" OR 7" LIFTS. REFER TO BOX KIT INSTRUCTIONS (64050 OR 67030) FOR INSTALLATION.
- ICON TRACK BAR (64038) REQUIRED FOR INSTALLATION.
- EXTENDED BRAKE LINE KIT AVAILABLE (61110) AS AN OPTION INSTEAD OF BRAKE LINE DROP BRACKETS.



### WARNING!

**\*\* READ ALL INSTRUCTIONS THOROUGHLY FROM START TO FINISH BEFORE BEGINNING INSTALLATION! IF THESE INSTRUCTIONS ARE NOT PROPERLY FOLLOWED SEVERE FRAME, SUSPENSION AND TIRE DAMAGE MAY RESULT TO THE VEHICLE!**

**\*\* ICON VEHICLE DYNAMICS RECOMMENDS THAT YOU EXERCISE EXTREME CAUTION WHEN WORKING UNDER A VEHICLE THAT IS SUPPORTED WITH JACK STANDS.**

**\*\* ICON VEHICLE DYNAMICS RECOMMENDS ALL INSTALLTION TO BE PERFORMED BY A PROFESSIONAL SHOP/SERVICE TECHNICIAN. PRODUCT FAILURE CAUSED BY IMPROPER INSTALLATION WILL NOT BE COVERED UNDER ICON'S WARRANTY POLICY.**

## INSTALLATION

**1.** Using a properly rated jack, raise the front end of the vehicle and support the frame rails with jack stands. The best positions to support the front of the truck are either the frame rails just behind the front bumper or on the body mounts just behind the front fenders. If lifting from the body mounts, be careful not to pinch the parking brake line on the driver's side. NEVER WORK UNDER AN UNSUPPORTED VEHICLE. Remove the front wheels.

**2.** Remove the sway bar links from the sway bar using an 18mm & 8mm. Leave them connected at the axle end. [FIGURE 1]



FIG.1



FIG.2

**3.** Disconnect the upper brake line brackets from the frame using a 13mm and lower brake line brackets from the axle using a 10mm. [FIGURE 2]

4. Remove the factory track bar using a 27mm and 30mm. (Refer to track bar #64038 instructions) [FIGURE 3]

FIG.3



5. Support the axle using a jack and remove the front shocks. The shocks are limiting droop so make sure that the axle is well supported or it will fall when the shocks are removed. Only remove the lower bolt using an 18mm.

6. Slowly lower the axle until the coils unload from the mounts. Be careful not to stretch or damage any lines connected to the differential or radius arms. Remove the coils. [FIGURE 4]

FIG.4



7. Some trucks have a transfer case skid plate that must be removed first using a 15mm. Remove the nut clips from the frame.

8. Lift the axle enough to reconnect the shocks and then lower the axle back down. [FIGURE 5]

FIG.5



FIG.6



9. With both coils removed, the radius arms don't have much force on them and can be safely removed from the frame mount using a 24mm & 27mm. [FIGURE 6]

10. Once the bolts are removed from the radius arms, lift up on the tie rod to rotate the axle rearward which will then rotate the radius arms out of their pockets. [FIGURE 7]

FIG.7



FIG.8



11. Remove the outside crossmember bolt on both sides. [FIGURE 8]

**12.** Position the driver side radius arm bracket into the radius arm pocket. Loosely install the supplied M18 X 139mm bolt with washers in the forward hole. Loosely install the supplied rear 3/4" X 5.5" bolt with washers into the radius arm holes. [FIGURE 9]

FIG.9

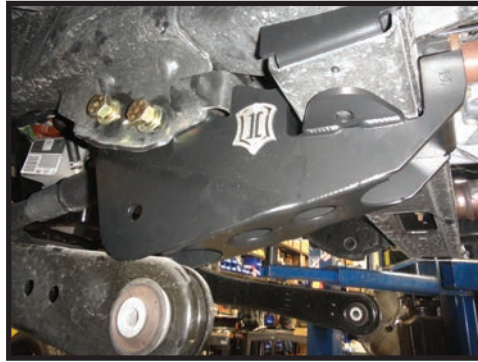

Spacers, washers, and a longer 12mm bolt are supplied to mount the radius arm bracket to the crossmember using a 19mm. The washers are used to account for the variances in crossmember placement in relation to the radius arm pockets. Position the supplied spacers and washers between the crossmember and radius arm bracket. One spacer must go on the driver and passenger (also front and rear) sides of the crossmember. Position the shims as needed. Four shims must be used on each side of the truck. The shim positioning may vary from one side to the other. [Torque to 65 ft-lbs] [FIGURE 10 & 11]

FIG.10



FIG.11



**13.** With both of the frame brackets installed loosely on the vehicle, tighten them to spec. Torque M18 bolts to factory spec using a 24mm & 27mm. Torque 3/4" bolts to 260 ft-lbs using an 1 1/8" & 1 1/16".

**14.** Slide the nut plate (164042) in the end of the crossmember and align over the hole. Using the supplied 5/8" bolts and lock washers, start the bolts in the nut plate mounting the radius arm bracket to the crossmember. Use the supplied 1/4" washer between the bracket and crossmember on the driver side only. [FIGURE 12]

FIG.12



FIG.13



**15.** Move the radius arms up into the pockets of the drop bracket and fasten with the factory bolt using a 24mm & 27mm. [Torque to factory spec] [FIGURE 13]

**16.** Remove the shocks and lower the axle enough to install the coil springs. [FIGURE 14]

FIG.14



**17.** Once the coils are in seated, install the shocks using an 18mm and 19mm. Be careful not to lift the truck off of its supports. [Torque to factory spec] [FIGURE 15]

FIG.15



FIG.16

**18.** Reconnect the sway bar links to the sway bar using an 8mm and 18mm. [Torque to factory spec] [FIGURE 16]

**19.** Install the ICON adjustable track bar (64038) using a 30mm. (Refer to track bar instructions) [FIGURE 17]

FIG.17



FIG.18

**20.** Mount the upper brake line drop brackets using a 13mm and the factory hardware. [Torque to factory spec] [FIGURE 18]  
Extended brake line kit (61110) available from ICON.

**21.** Mount the brake line to the drop bracket with the supplied bolt and washer using a 1/2". [Torque to 13 ft-lbs] [FIGURE 18]

**22.** Mount the lower brake line brackets using the factory bolt and a 10mm. [Torque to factory spec]. [FIGURE 19]

FIG.19



**23.** Install the wheels/tires and lower the vehicle to the ground. [Torque lugs to factory spec]

**24.** Center the front axle under the truck using the adjustable track bar. Center the steering wheel. Refer to track bar instructions.

**25.** Have the vehicle professionally aligned.

***VERIFY ALL FASTENERS ARE PROPERLY TORQUED BEFORE DRIVING VEHICLE.***

***RETORQUE ALL NUTS, BOLTS AND LUGS AFTER 100 MILES AND PERIODICALLY THEREAFTER.***

## **ICON VEHICLE DYNAMICS LIMITED LIFETIME WARRANTY**

ICON Vehicle Dynamics warrants to the original retail purchaser who owns the vehicle on which the product was originally installed. ICON Vehicle Dynamics does not warrant the product for finish, alterations, modifications and/or installation contrary to ICON Vehicle Dynamics instructions. ICON Vehicle Dynamics products are not designed, nor are they intended to be installed on vehicles used in race applications, for racing purposes or for similar activities. (A "race" is defined as any contest between two or more vehicles, or a contest of one or more vehicles against the clock, whether or not such contest is for a prize). This warranty does not include coverage for police or taxi vehicles, race vehicles, or vehicles used for government or commercial purposes. Also excluded from this warranty are sales outside of the United States of America and Canada.

ICON Vehicle Dynamics' obligation under this warranty is limited to the repair or replacement, at ICON Vehicle Dynamics' discretion, of the defective product. Any and all costs of removal, installation or re-installation, freight charges and incidental or consequential damages are expressly excluded from this warranty. Items that are subject to wear are not considered defective when worn and are not covered.

ICON Vehicle Dynamics components must be installed as a complete kit as shown in our current application guide. Any substitutions or exemptions of required components will immediately void the warranty. Some finish damage may happen to parts during shipping and is not covered under warranty.

This warranty is expressly in lieu of all other warranties expressed or implied. This warranty shall not apply to any product that has been improperly installed, modified or customized subject to accident, negligence, abuse or misuse.

# **ICON VEHICLE DYNAMICS**

PERFORMANCE SUSPENSION SYSTEMS AND SHOCK ABSORBERS

7929 Lincoln Ave. Riverside, CA 92504 Phone: 951.689.ICON Fax: 951.689.1016  
[www.iconvehicledynamics.com](http://www.iconvehicledynamics.com)



**FOLLOW US ON FACEBOOK!**



7929 Lincoln Ave. Riverside, CA 92504  
 Phone: 951.689.ICON Fax: 951.689.1016

PART #	DESCRIPTION
66513	05-UP FSD 4WD 4.5" FRONT 2.0 VS IR

COMPONENTS INCLUDED	
(1) 164913 05-UP FSD 4WD 4.5" FRONT 2.0 VS IR	(1) 611006 9/16" HD STEM BUSHING KIT
HARDWARE INCLUDED	
611006 HARDWARE KIT	
(2) HEAVY DUTY 9/16 ID STEM BUSHING (2) HEAVY DUTY STEM BUSHING RETAINER	(1) M12-1.25 NUT THIN (1) M12-1.25 JAM NUT
TOOLS REQUIRED	
JACK JACK STANDS TORQUE WRENCH	17MM SOCKET / WRENCH 18MM SOCKET / WRENCH 19MM SOCKET / WRENCH 21MM SOCKET / WRENCH
TECH NOTES	
<p>1. YOUR ICON SHOCK ASSEMBLIES COME FACTORY CHARGED TO 180 PSI. RELEASING NITROGEN PRESSURE MAY LEAD TO SHOCK MALFUNCTION AND REDUCED RIDE QUALITY. FAILURE CAUSED BY LOW NITROGEN PRESSURE IS NOT COVERED UNDER ICON'S WARRANTY POLICY.</p>	



**WARNING!**

**\*\* READ ALL INSTRUCTIONS THOROUGHLY FROM START TO FINISH BEFORE BEGINNING INSTALLATION! IF THESE INSTRUCTIONS ARE NOT PROPERLY FOLLOWED SEVERE FRAME, SUSPENSION AND TIRE DAMAGE MAY RESULT TO THE VEHICLE!**

**\*\* ICON VEHICLE DYNAMICS RECOMMENDS THAT YOU EXERCISE EXTREME CAUTION WHEN WORKING UNDER A VEHICLE THAT IS SUPPORTED WITH JACK STANDS.**

**\*\* ICON VEHICLE DYNAMICS RECOMMENDS ALL INSTALLTION TO BE PERFORMED BY A PROFESSIONAL SHOP/SERVICE TECHNICIAN. PRODUCT FAILURE CAUSED BY IMPROPER INSTALLATION WILL NOT BE COVERED UNDER ICON'S WARRANTY POLICY.**

## INSTALLATION

- Using a properly rated jack, raise the front of the vehicle and support the frame rails with jack stands. Ensure the jack stands are secure and set properly before lowering the jack. NEVER WORK UNDER AN UNSUPPORTED VEHICLE. Remove the front wheels.
- Remove the factory shocks using a 17mm and 18mm socket/wrench.
- Install the shock stem bushing kit onto the factory shock mount as follows: 9/16" stem washer, stem bushing (locator lip up), factory shock mount, stem bushing (locator lip down), 12mm stem washer, 12mm nut. Fasten until bushing assembly is snug but do not overtighten. (19mm) Install the factory lower bolt. (18mm & 21mm) [FIGURE 1]

FIG.1

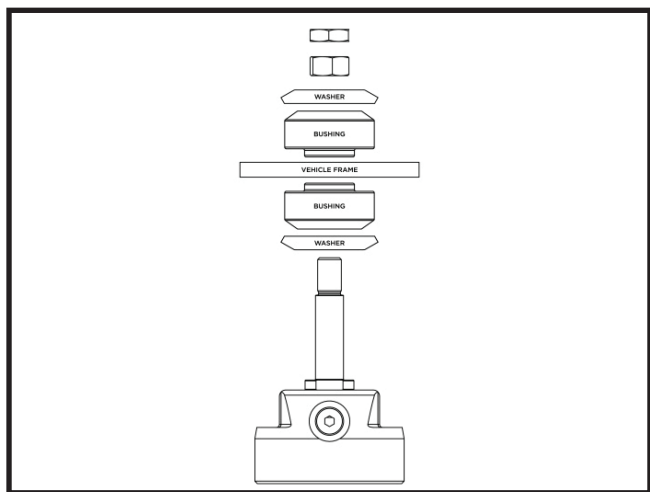

- Reinstall wheels and lower vehicle back to the ground. [Torque lugs to factory spec]

**VERIFY ALL FASTENERS ARE PROPERLY TORQUED BEFORE DRIVING VEHICLE.**

**RETORQUE ALL NUTS, BOLTS AND LUGS AFTER 100 MILES AND PERIODICALLY THEREAFTER.**

## 2.0 ALUMINUM SERIES TECHNICAL INFORMATION

### MAINTENANCE

ICON shock absorbers are a high quality rebuildable race style shock absorber designed for optimal performance. With a unit of this caliber on your vehicle, routine maintenance is required to keep them looking and operating in like new condition. Residual oil and assembly lube may be present at all seal paths from the factory out of the box and is considered normal. Pooling of oil however is not acceptable at any time and one should contact the ICON dealer where purchased.

**BELOW ARE GUIDELINES BASED ON HOW YOU USE YOUR VEHICLE BUT YOUR MILEAGE MAY VARY:**

#### **STREET USE:**

- Send in for factory servicing every 40,000 miles or if a leak develops, ride quality decreases, or they begin to make excessive noise.
- Remove any buildup of road salt, mud, or debris from shocks anytime accrued
- Clean with mild soap and water with each oil change or anytime you notice build up.
- Wax the cylinders yearly with automotive wax to prevent corrosion.
- Check nitrogen pressure yearly. (252004 charge needle assembly available at any ICON distributor)

#### **STREET/DIRT:**

- Send in for factory servicing every 15,000 miles or if a leak develops, ride quality decreases, or they begin to make excessive noise.
- Clean with mild soap and water with each oil change, offroad trip, or anytime you notice build up.
- Wax the cylinders yearly with automotive wax to prevent corrosion.
- Check nitrogen pressure each dirt outing. (252004 charge needle assembly available at any ICON distributor)

#### **DIRT USE:**

- Send in for factory servicing every 1,000 miles.
- Check nitrogen pressure each outing. (252004 charge needle assembly available at any ICON distributor)
- Remove any buildup of mud or debris from shocks after every outing.

#### **SELF-SERVICE:**

- Contact ICON for service kits & tools at (951) 689-4266.

### PRODUCT REGISTRATION

Please visit: <http://www.iconvehicledynamics.com/tech-support/registration/> to register your product.

### ICON VEHICLE DYNAMICS SHOCK ABSORBER WARRANTY

This shock absorber has a 1 year warranty against any manufacturer's defects. If a shock fails within the initial year of ownership, the shock must be shipped to ICON Vehicle Dynamics for inspection and service. If a shock is inspected and it has been determined the shock failed due to neglect, damage caused by improper installation or any other reason besides "normal wear and tear", the owner of said shock is responsible for all service costs. This includes labor, parts, and shipping.

ICON Vehicle Dynamics warrants to the original retail purchaser who owns the vehicle on which the product was originally installed. ICON Vehicle Dynamics does not warrant the product for finish, alterations, modifications and/or installation contrary to ICON Vehicle Dynamics instructions. ICON Vehicle Dynamics products are not designed, nor are they intended to be installed on vehicles used in race applications, for racing purposes or for similar activities. (A "race" is defined as any contest between two or more vehicles, or a contest of one or more vehicles against the clock, whether or not such contest is for a prize). This warranty does not include coverage for police or taxi vehicles, race vehicles, or vehicles used for government or commercial purposes. Also excluded from this warranty are sales outside of the United States of America and Canada.

ICON Vehicle Dynamics' obligation under this warranty is limited to the repair or replacement, at ICON Vehicle Dynamics' discretion, of the defective product. Any and all costs of removal, installation or re-installation, freight charges and incidental or consequential damages are expressly excluded from this warranty. Items that are subject to wear are not considered defective when worn and are not covered.

ICON Vehicle Dynamics components must be installed as a complete kit as shown in our current application guide. Any substitutions or exemptions of required components will immediately void the warranty. Some finish damage may happen to parts during shipping and is not covered under warranty.

This warranty is expressly in lieu of all other warranties expressed or implied. This warranty shall not apply to any product that has been improperly installed, modified or customized subject to accident, negligence, abuse or misuse.

To send a shock in for warranty please visit our website <http://www.iconvehicledynamics.com/tech-support/shock-service/>

## ICON VEHICLE DYNAMICS

PERFORMANCE SUSPENSION SYSTEMS AND SHOCK ABSORBERS

7929 Lincoln Ave. Riverside, CA 92504 Phone: 951.689.ICON Fax: 951.689.1016  
[www.iconvehicledynamics.com](http://www.iconvehicledynamics.com)



FOLLOW US ON FACEBOOK!



7929 Lincoln Ave. Riverside, CA 92504  
 Phone: 951.689.ICON Fax: 951.689.1016

PART #	DESCRIPTION
66516	17-UP FSD 4WD 0-2" REAR 2.0 VS IR

COMPONENTS INCLUDED	
(1) 164917 17-UP FSD 4WD 0-2" REAR 2.0 VS IR	
HARDWARE INCLUDED	
N/A	
TOOLS REQUIRED	
JACK JACK STANDS TORQUE WRENCH	18MM SOCKET / WRENCH 21MM SOCKET / WRENCH
TECH NOTES	
<p>1. YOUR ICON SHOCK ASSEMBLIES COME FACTORY CHARGED TO 180 PSI. RELEASING NITROGEN PRESSURE MAY LEAD TO SHOCK MALFUNCTION AND REDUCED RIDE QUALITY. FAILURE CAUSED BY LOW NITROGEN PRESSURE IS NOT COVERED UNDER ICON'S WARRANTY POLICY.</p>	



WARNING!
<p><b>** READ ALL INSTRUCTIONS THOROUGHLY FROM START TO FINISH BEFORE BEGINNING INSTALLATION! IF THESE INSTRUCTIONS ARE NOT PROPERLY FOLLOWED SEVERE FRAME, SUSPENSION AND TIRE DAMAGE MAY RESULT TO THE VEHICLE!</b></p> <p><b>** ICON VEHICLE DYNAMICS RECOMMENDS THAT YOU EXERCISE EXTREME CAUTION WHEN WORKING UNDER A VEHICLE THAT IS SUPPORTED WITH JACK STANDS.</b></p> <p><b>** ICON VEHICLE DYNAMICS RECOMMENDS ALL INSTALLTION TO BE PERFORMED BY A PROFESSIONAL SHOP/SERVICE TECHNICIAN. PRODUCT FAILURE CAUSED BY IMPROPER INSTALLATION WILL NOT BE COVERED UNDER ICON'S WARRANTY POLICY.</b></p>

## INSTALLATION

- Using a properly rated jack, raise the front of the vehicle and support the frame rails with jack stands. Ensure the jack stands are secure and set properly before lowering the jack. NEVER WORK UNDER AN UNSUPPORTED VEHICLE.
- Remove the factory shocks using 18mm and 21mm socket/wrenchS.
- Slide the shock into the upper shock mount and fasten using an 18mm with the factory hardware. [Torque to factory spec]
- Position the rod end in the lower mount and slide the bolt in. Fasten using an 18mm and 21mm with the factory hardware. [Torque to factory spec]
- Lower the vehicle back to the ground.

**VERIFY ALL FASTENERS ARE PROPERLY TORQUED BEFORE DRIVING VEHICLE.**

**RETORQUE ALL NUTS, BOLTS AND LUGS AFTER 100 MILES AND PERIODICALLY THEREAFTER.**

## 2.0 ALUMINUM SERIES TECHNICAL INFORMATION

### MAINTENANCE

ICON shock absorbers are a high quality rebuildable race style shock absorber designed for optimal performance. With a unit of this caliber on your vehicle, routine maintenance is required to keep them looking and operating in like new condition. Residual oil and assembly lube may be present at all seal paths from the factory out of the box and is considered normal. Pooling of oil however is not acceptable at any time and one should contact the ICON dealer where purchased.

**BELOW ARE GUIDELINES BASED ON HOW YOU USE YOUR VEHICLE BUT YOUR MILEAGE MAY VARY:**

#### **STREET USE:**

- Send in for factory servicing every 40,000 miles or if a leak develops, ride quality decreases, or they begin to make excessive noise.
- Remove any buildup of road salt, mud, or debris from shocks anytime accrued
- Clean with mild soap and water with each oil change or anytime you notice build up.
- Wax the cylinders yearly with automotive wax to prevent corrosion.
- Check nitrogen pressure yearly. (252004 charge needle assembly available at any ICON distributor)

#### **STREET/DIRT:**

- Send in for factory servicing every 15,000 miles or if a leak develops, ride quality decreases, or they begin to make excessive noise.
- Clean with mild soap and water with each oil change, offroad trip, or anytime you notice build up.
- Wax the cylinders yearly with automotive wax to prevent corrosion.
- Check nitrogen pressure each dirt outing. (252004 charge needle assembly available at any ICON distributor)

#### **DIRT USE:**

- Send in for factory servicing every 1,000 miles.
- Check nitrogen pressure each outing. (252004 charge needle assembly available at any ICON distributor)
- Remove any buildup of mud or debris from shocks after every outing.

#### **SELF-SERVICE:**

- Contact ICON for service kits & tools at (951) 689-4266.

### PRODUCT REGISTRATION

Please visit: <http://www.iconvehicledynamics.com/tech-support/registration/> to register your product.

### ICON VEHICLE DYNAMICS SHOCK ABSORBER WARRANTY

This shock absorber has a 1 year warranty against any manufacturer's defects. If a shock fails within the initial year of ownership, the shock must be shipped to ICON Vehicle Dynamics for inspection and service. If a shock is inspected and it has been determined the shock failed due to neglect, damage caused by improper installation or any other reason besides "normal wear and tear", the owner of said shock is responsible for all service costs. This includes labor, parts, and shipping.

ICON Vehicle Dynamics warrants to the original retail purchaser who owns the vehicle on which the product was originally installed. ICON Vehicle Dynamics does not warrant the product for finish, alterations, modifications and/or installation contrary to ICON Vehicle Dynamics instructions. ICON Vehicle Dynamics products are not designed, nor are they intended to be installed on vehicles used in race applications, for racing purposes or for similar activities. (A "race" is defined as any contest between two or more vehicles, or a contest of one or more vehicles against the clock, whether or not such contest is for a prize). This warranty does not include coverage for police or taxi vehicles, race vehicles, or vehicles used for government or commercial purposes. Also excluded from this warranty are sales outside of the United States of America and Canada.

ICON Vehicle Dynamics' obligation under this warranty is limited to the repair or replacement, at ICON Vehicle Dynamics' discretion, of the defective product. Any and all costs of removal, installation or re-installation, freight charges and incidental or consequential damages are expressly excluded from this warranty. Items that are subject to wear are not considered defective when worn and are not covered.

ICON Vehicle Dynamics components must be installed as a complete kit as shown in our current application guide. Any substitutions or exemptions of required components will immediately void the warranty. Some finish damage may happen to parts during shipping and is not covered under warranty.

This warranty is expressly in lieu of all other warranties expressed or implied. This warranty shall not apply to any product that has been improperly installed, modified or customized subject to accident, negligence, abuse or misuse.

To send a shock in for warranty please visit our website <http://www.iconvehicledynamics.com/tech-support/shock-service/>

## ICON VEHICLE DYNAMICS

PERFORMANCE SUSPENSION SYSTEMS AND SHOCK ABSORBERS

7929 Lincoln Ave. Riverside, CA 92504 Phone: 951.689.ICON Fax: 951.689.1016  
[www.iconvehicledynamics.com](http://www.iconvehicledynamics.com)



FOLLOW US ON FACEBOOK!

