

## Introduction and Features

The RPK4-FD2201 is a complete radio replacement kit with integrated climate control retention for the 2015-2020 Ford F-150 and 2017-2022 Ford Super Duty equipped with the 4" screen. This kit utilizes the factory HVAC control knobs for a more factory look and experience. This kit also includes all of the modules and cables needed to retain all of the important features of the factory system such as: steering wheel mounted radio controls, factory reverse camera, AM/FM reception, and the factory USB port (if equipped). With the addition of the VS41 (sold separately) you can also add blind spot cameras and a front camera to the aftermarket radio.

## Important Notes

1. We recommend that you read this manual thoroughly to familiarize yourself with the entire process before beginning installation.
2. Transfer of the factory HVAC knobs, circuit boards, and auxiliary button panel is required. Professional installation is recommended.
3. **WARNING!** Failure to install the supplied ribbon cables properly will result in **LOSS OF or INTERMITTENT** operation of **CLIMATE CONTROLS!** Follow instructions carefully!
4. Only compatible in vehicles equipped with the 4" screen.
5. Does not retain SYNC.
6. Does not retain auxiliary input jack in 2015 vehicles equipped with SYNC.
7. Does not retain external temperature displayed on factory screen.
8. Only one of the reverse camera retention harnesses will be used.
9. Once the radio is removed, the chimes will play through the small dash speaker and not the cabin speakers.
10. Use of improper length screws during kit re-assembly can result in damage to this product. Please pay special attention to Part Three: Step 6, and **DO NOT** use the 22mm long screws. Damage will occur!! 22mm long screws are only used in Part Three: Step 9.
11. **If your vehicle uses the new style (Square Housing: See below image number 14), plug this adapter (RPK4-FD2X02-HAR) into the main radiopro harness (Image number 9).**

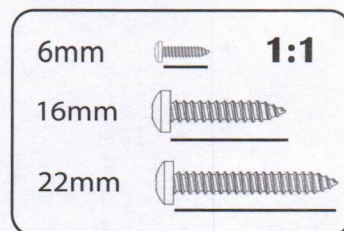

## Components

Tools needed for installation : 7mm socket, 10mm socket, ratchet, T10 torx screwdriver, small flathead screwdriver, plastic panel removal tool .

1. Dash Panel with HVAC Control
2. Middle Circuit Board Housing
3. Bottom Circuit Board Housing
4. Pocket (For single DIN applications)
5. (x2) Radio Brackets (left and right)
6. AM / FM Antenna Adapter
7. (x2) Reverse Camera Retention Harness (used only when equipped with factory reverse camera. Only one will be used.)
8. (x2) Ribbon Cables
9. RP4.2 Interface Harness
10. (x8) 6mm Screws
11. (x9) Radio Mounting Screws
12. USB Retention Cable (if equipped)
13. RP4.2 Interface
14. RP4.2 Vehicle Year Expansion Harness (For use with 2020+ applications)

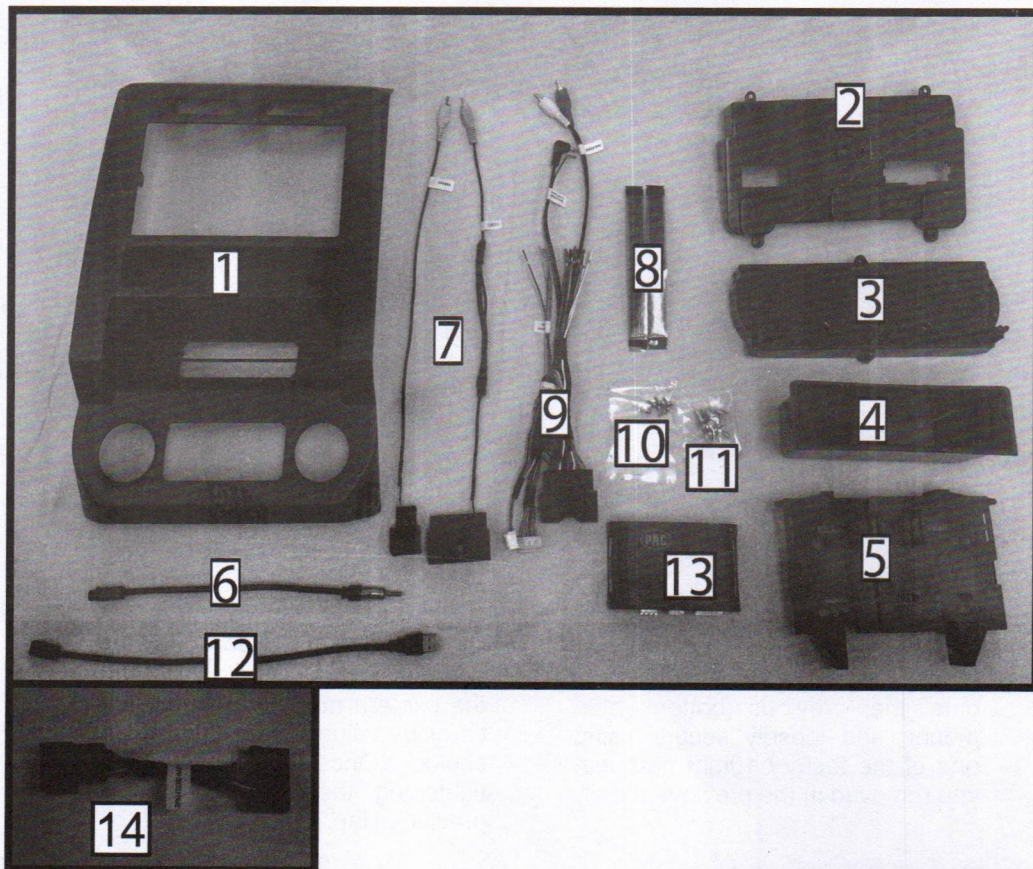

## Installation

### Part One: Disassembly of Factory Dash

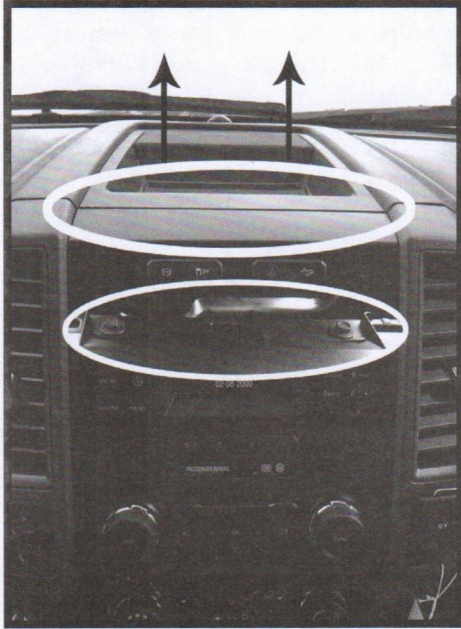

1. Remove front dash panel from vehicle by prying up on the top dash panel with a plastic pry tool, then removing the two 7mm screws located under the top dash panel.



2. Remove the factory screen, SYNC module (if equipped), and Audio Control Module (ACM) using a 7mm socket. These parts are no longer needed. They can be stored away in case you ever decide to re-install the factory radio.

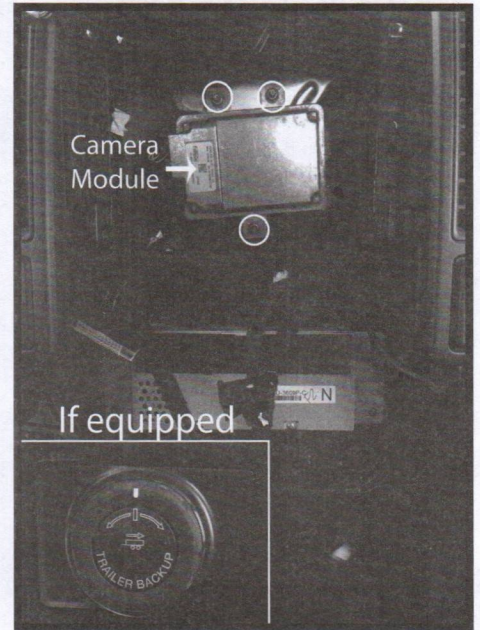

3. If vehicle is equipped with a factory camera module, it must be relocated. Remove the three nuts securing it using a 10mm socket.



4. Place the top right mounting bracket onto the previous bottom stud mount, and loosely secure using one of the factory 10mm nuts that you removed in the previous step.

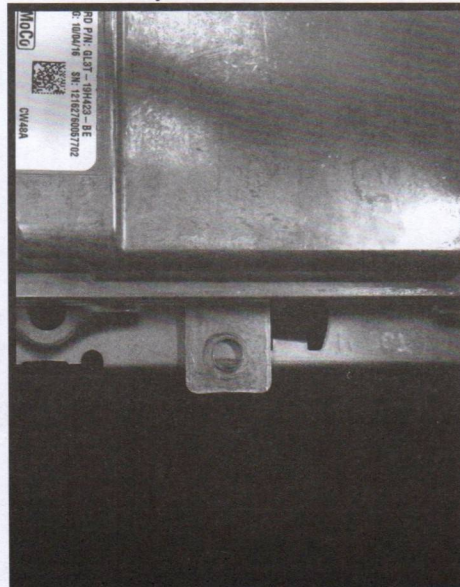

5. You can now secure the bottom of the camera module by using a zip tie or by using the fastener of your choice. Once completed, finish tightening the top nut from the previous step.

This is the end of part one. Please continue to the next page to begin part two.

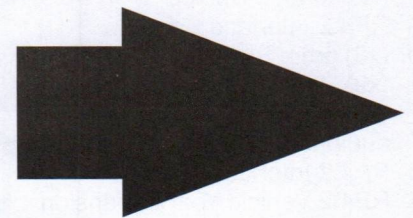

## Part Two: Disassembly of Factory Dash Panel

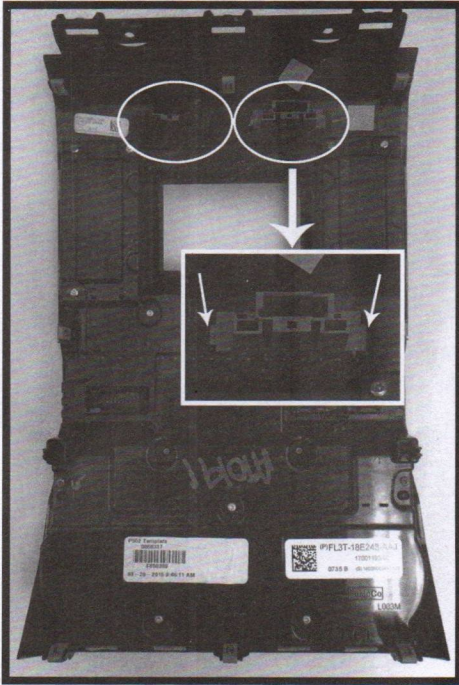

1. Remove hazard and traction control buttons from factory dash panel by pushing in on the release tabs. Set aside for later use.

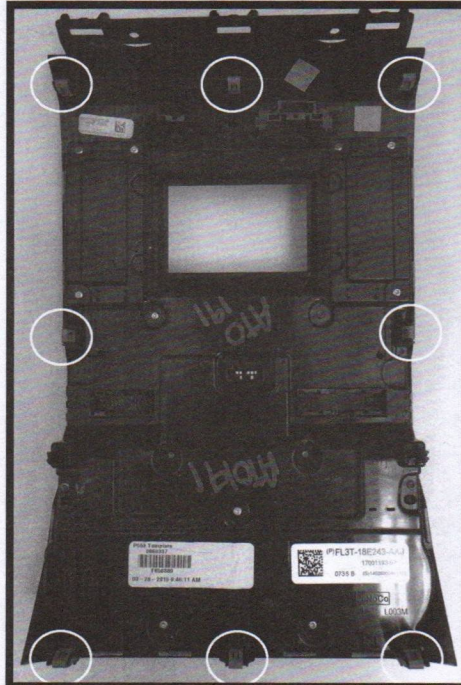

2. Remove (8) orange clips from factory dash panel using a small flathead screwdriver. Set aside for later use.

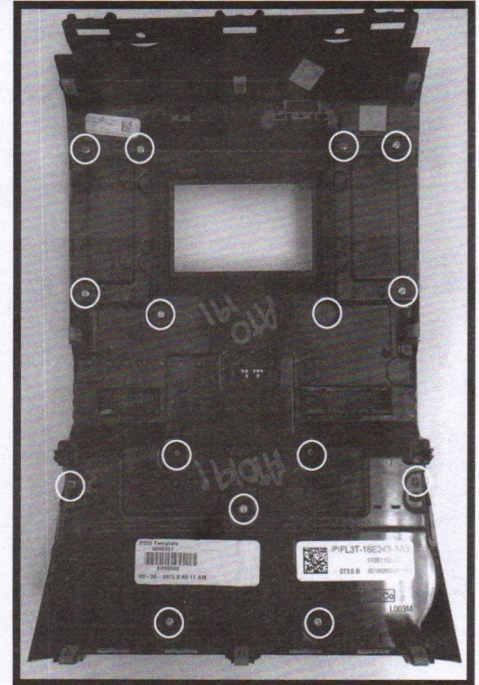

3. Remove (15) T10 22mm screws from factory dash panel. Set (3) aside for later use.

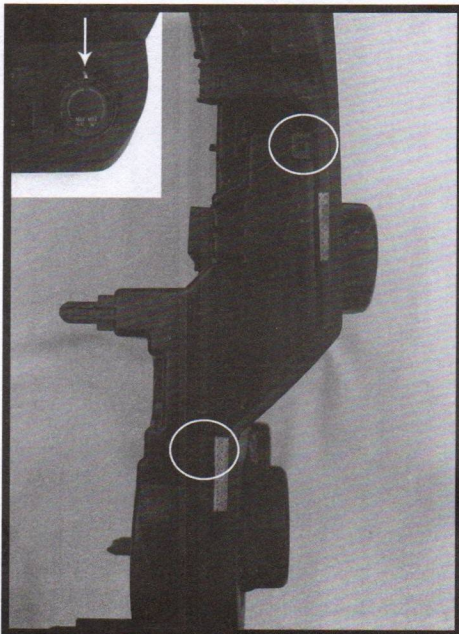

4. Make sure that the white line on the temperature control knob is centered at the top. Remove back of factory dash panel by releasing the locking tabs on each side.

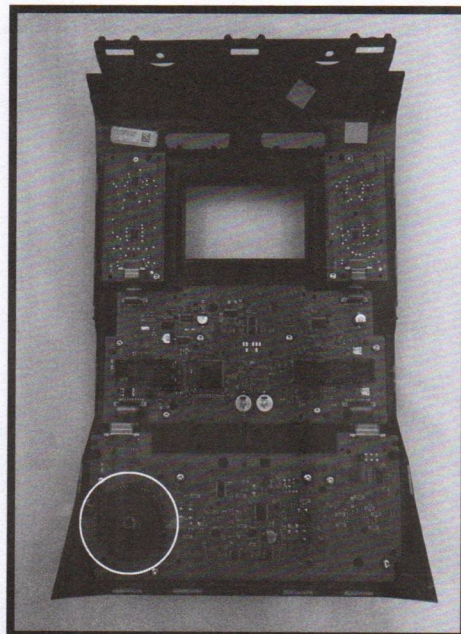

5. Remove black plastic gear from back of circuit board. Set aside for later use.

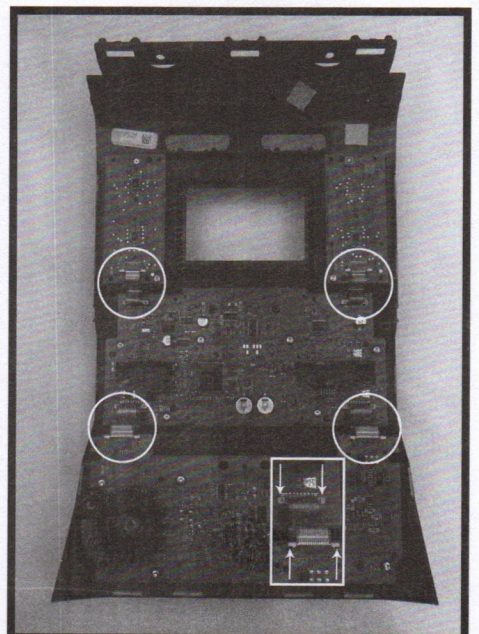

6. Remove (4) ribbon cables from circuit boards on factory dash panel by pulling out on the white release tabs.

## Disassembly of Factory Dash Panel (cont.)

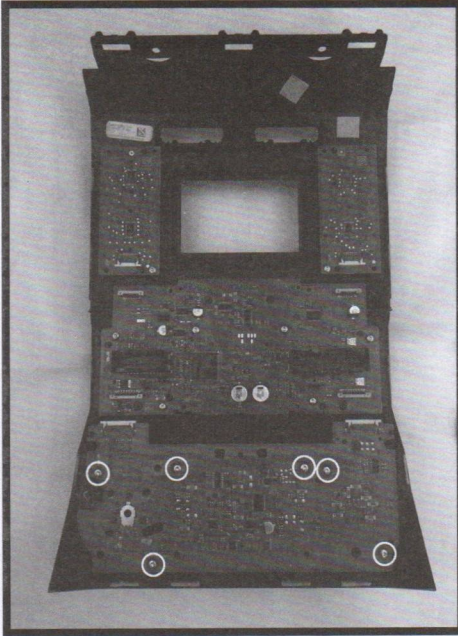

7. Remove (6) T10 16mm screws from bottom circuit board. Set aside for later use.

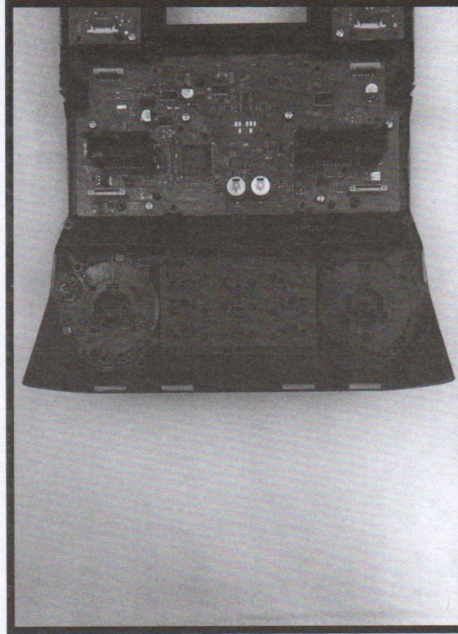

8. Remove bottom circuit board and set aside for later use.

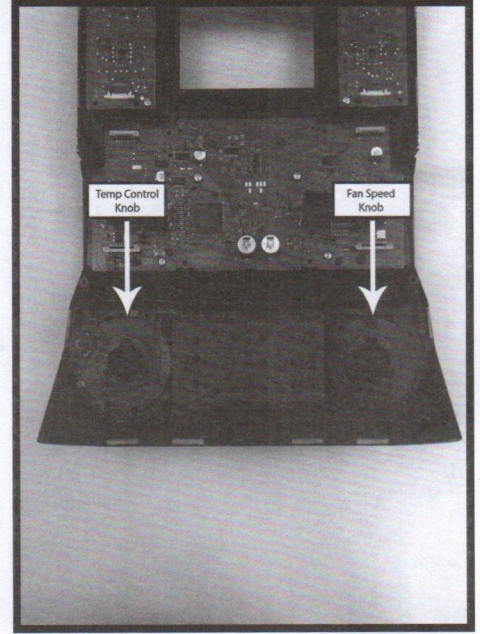

9. Remove temperature control and fan speed knobs. Set aside for later use.

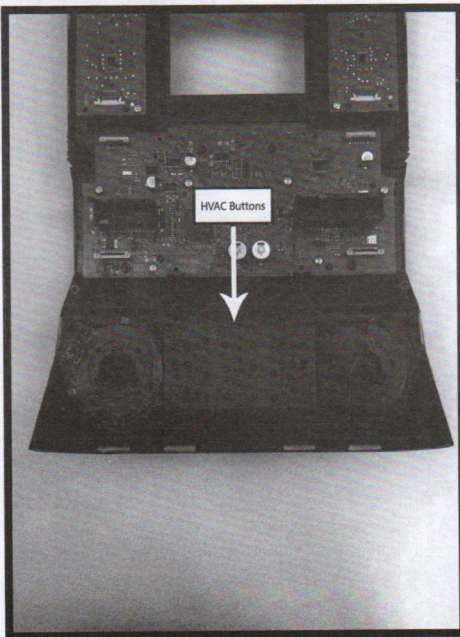

10. Remove HVAC buttons (make sure the rubber button pad comes with it). Set aside for later use.

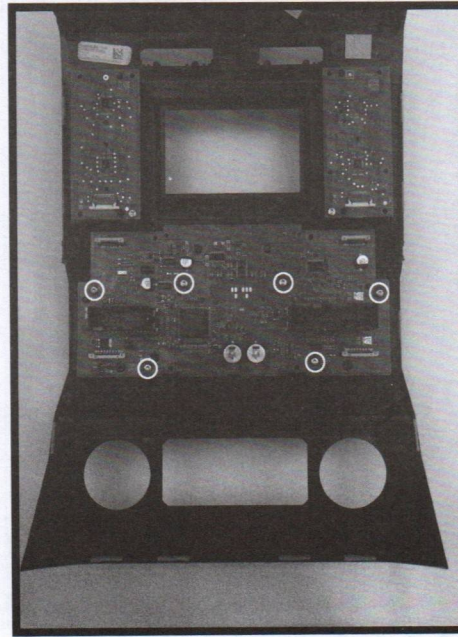

11. Remove (6) T10 16mm screws from middle circuit board. Set (2) aside with the (6) from step 7 for later use.

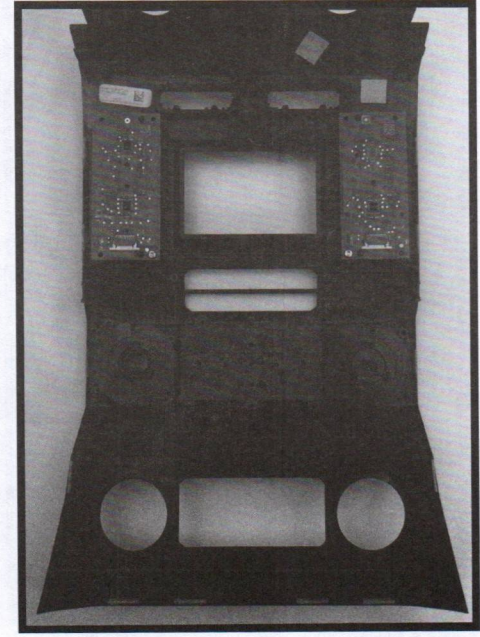

12. Remove middle circuit board and set aside for later use. Make sure that the rubber pads for the buttons and knobs stay behind with the factory dash panel.

## Disassembly of Factory Dash Panel (cont.)

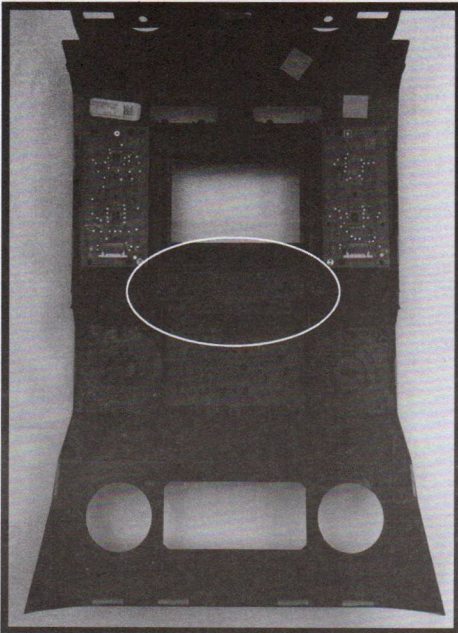

13. Remove the auxiliary button pad (make sure the rubber button pad comes with it) and set aside for later use.



14. You may now take the remaining pieces of the dash panel, along with the (16) T10 screws - (12) 22mm and (4) 16mm - and (4) ribbon cables and store them away. These will be needed if you ever decide to reinstall the factory radio. Please do not randomly use these screws when assembling the aftermarket dash kit. Use specified screws only.

This is the end of part two. Please continue to the next section to begin part three.

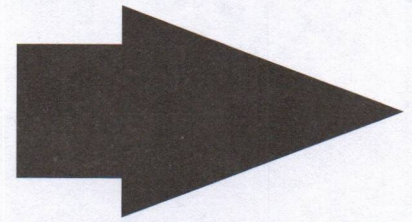

## Part Three: Assembly of Aftermarket Dash Kit

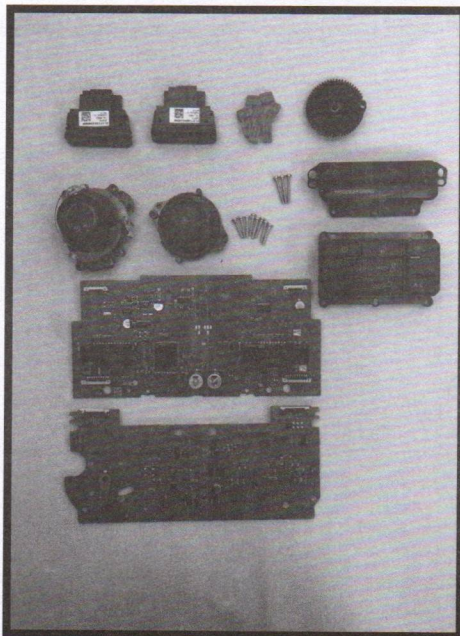

1. These are the components you should have set aside from part two.



2. Insert the appropriate upper dash button trim bezel (2 or 3 button) into the kit. Use the (2) supplied T10 6mm screws to secure the bezel into place, and insert the buttons that were removed during disassembly (step 1 page 3).



3. Flip the panel over and install the HVAC buttons as shown. Make sure the alignment tabs set correctly.

## Assembly of Aftermarket Dash Kit (cont.)

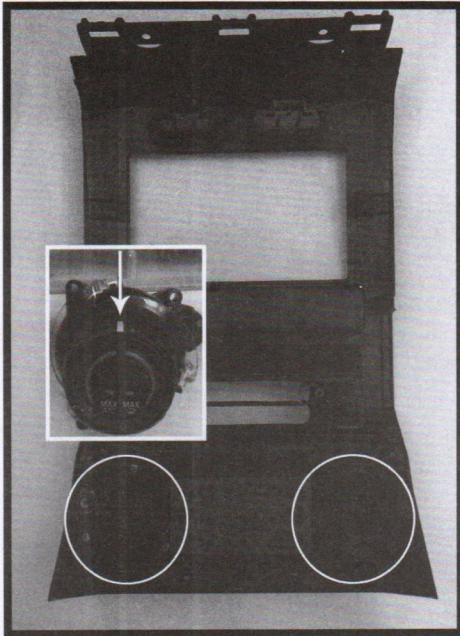

4. Install the temperature and fan speed knobs as shown. Please make sure that the white line on the temperature control knob is centered at the top.

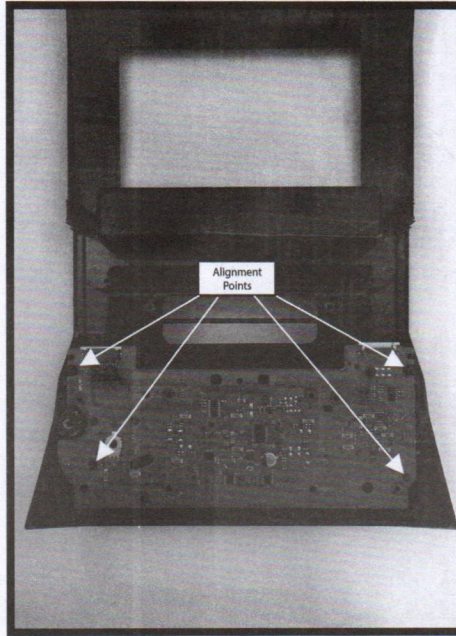

5. Install the bottom circuit board as shown. Make sure that the rubber pads on the board fit snugly into the previously installed knobs.

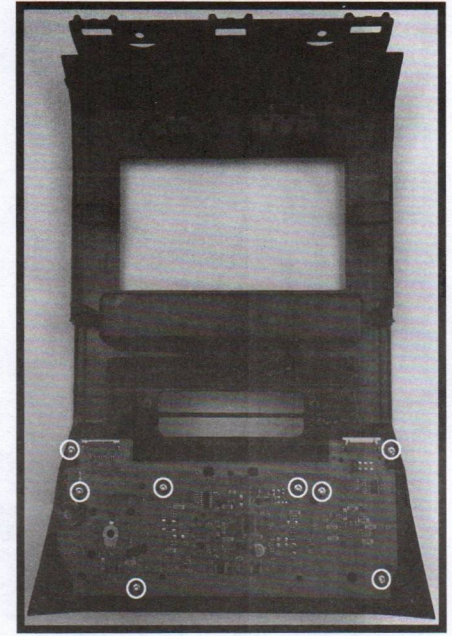

6. Using the (8) 16mm screws you kept from Part Two:Steps 7 & 11, secure the circuit board to the panel as shown.

16mm  1:1

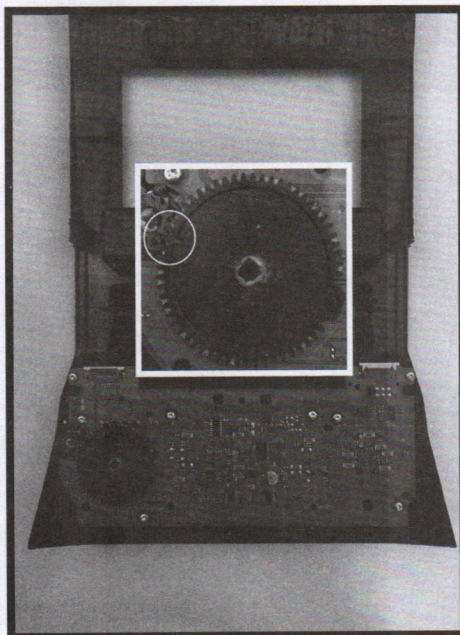

7. Install the black plastic gear as shown. Make sure the alignment mark on the gear is pointing at the gear attached to the temperature control knob.

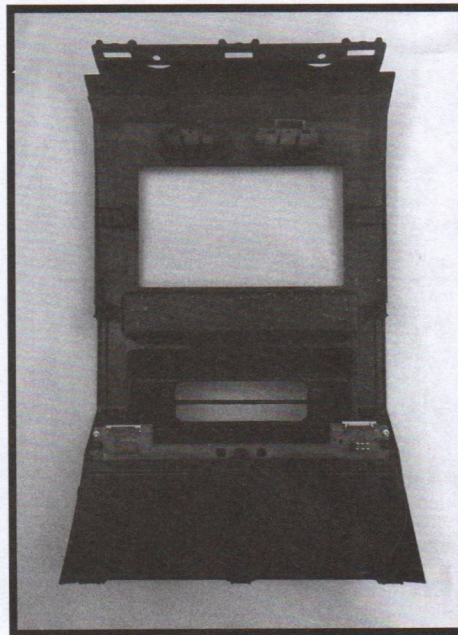

8. Install the bottom circuit board housing as shown.



9. Using the (3) 22mm T10 screws you Part Two: Step 3, secure the circuit board housing to the panel as shown.

22mm  1:1

## Assembly of Aftermarket Dash Kit (cont.)

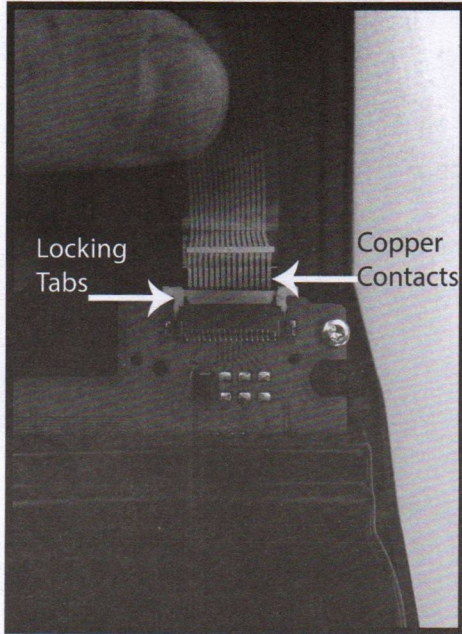

10. Connect the (2) supplied ribbon cables to the bottom circuit board as shown. Make sure that the copper contacts on the ribbon cables are facing towards you. Once the cables are seated in the connector, lock them in place by pushing down on the locking tabs.

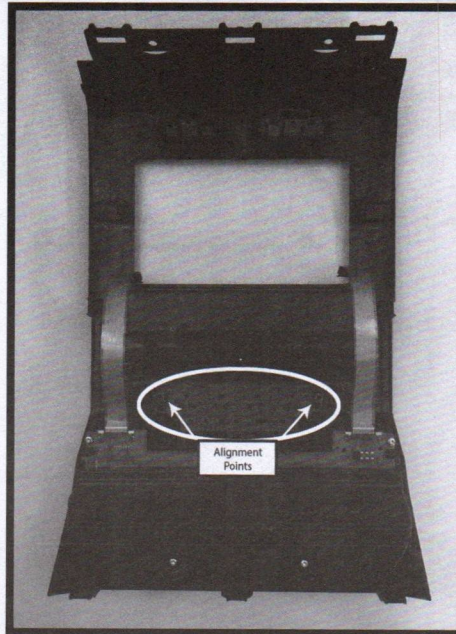

11. Install the auxiliary button panel assembly as shown.

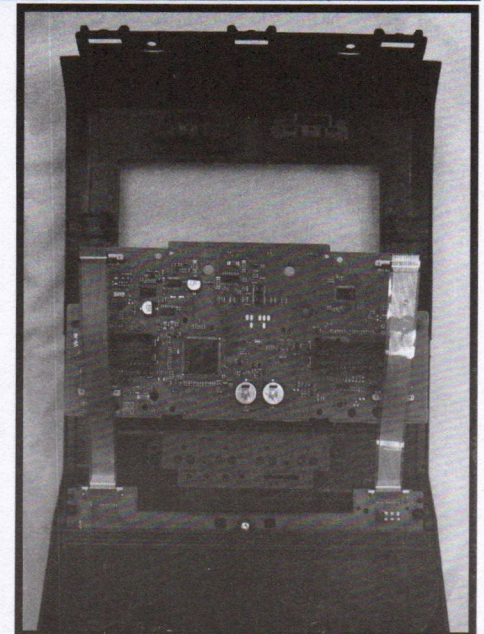

12. Temporarily place the middle circuit board on the kit, just above the auxiliary button panel. Position the (2) ribbon cables as shown. These will need to be connected to the bottom of the middle circuit board in the next step.

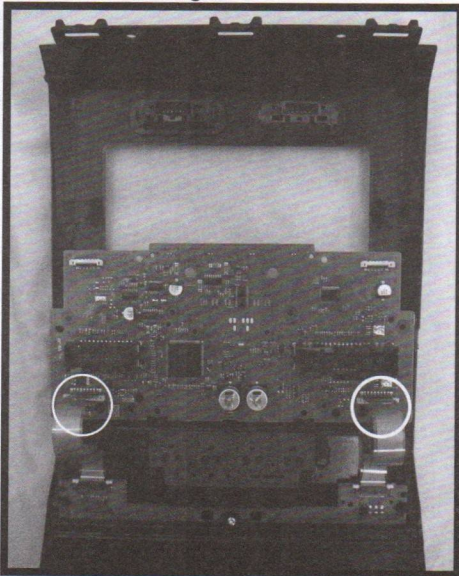

13. Connect the free ends of both ribbon cables to the corresponding connectors on the circuit board as shown. You may need to lift up on the white lock tabs, to insert the ribbon cables. Once the cables are seated a slight click is felt. Then push down on the white locking tabs.

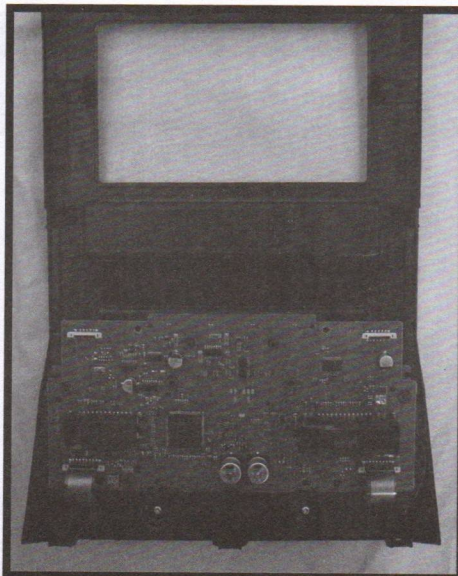

14. Carefully align the middle circuit board over the bottom circuit board as shown.

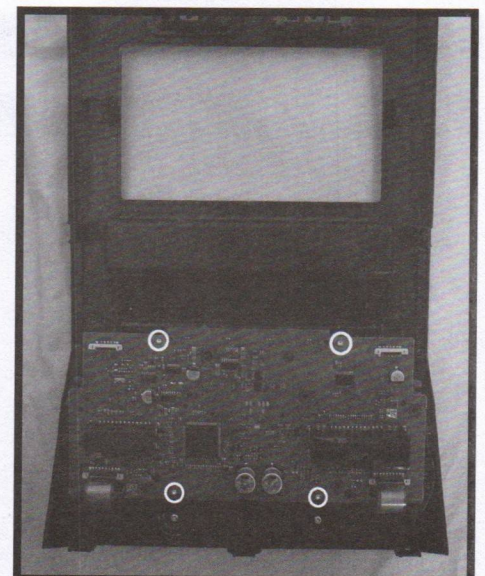

15. Using (4) of the supplied 6mm T10 screws, secure the circuit board to the panel as shown.



## Assembly of Aftermarket Dash Kit (cont.)

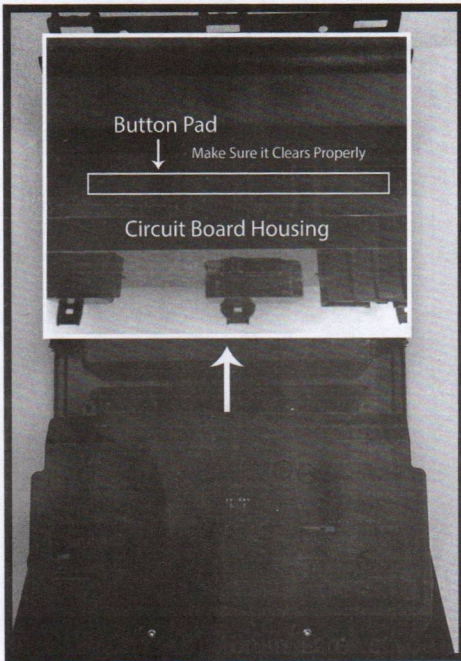

16. Install the middle circuit board housing as shown. Make sure that the top of the housing clears the auxiliary button pad during placement.



17. Using (4) of the supplied 6mm T10 screws, secure the housing to the panel as shown.



This is the end of part three. Please continue to the next section to begin part four.



## Part Four: Configuring and Wiring the RadioPRO Interface

### Module Layout

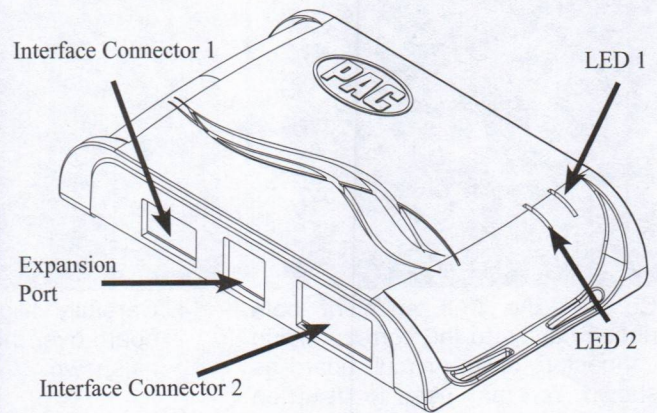
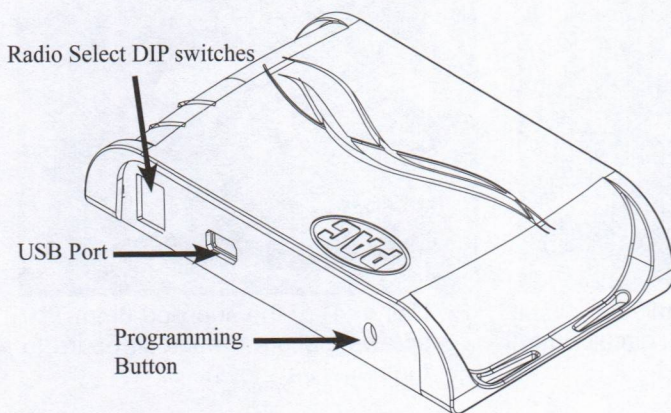

## DIP Switches and Wiring Connections



Set DIP switches that match your radio to the ON position  
Set all other DIP switches to the OFF position

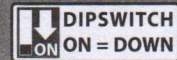

Alpine	JVC	Kenwood	Clarion	Pioneer/Other	Sony	Fusion
1	2	1 & 2	3	1, 2, & 3	4	1 & 4

Other = Advent, BOYO, Dual, Lightning Audio, Rockford Fosgate, Visteon

1. The radio select DIP switches on the side of the interface must be adjusted to the proper radio setting before plugging the interface into the vehicle.
2. Make all connections as described in the connection chart below. Please see page 12 for a full description of the functions and connectivity of the red / white wire.
3. If the vehicle is equipped with a factory reverse camera, connect the included reverse camera retention harness to either the 12-pin or 54-pin plug found behind the factory 4" monitor (only one will be present). Connect the yellow RCA to the aftermarket radio's reverse camera input.
4. Connect the SWC output wire according to the chart below (aftermarket radio must support a wired remote input).
5. If you are adding blind spot and / or front cameras, wire up the VS41 (sold separately) as outlined on the next page.
6. Once all connections have been made, plug the interface into the vehicle. It is recommended that this be done with the vehicle running. Once the interface has been connected the LED will blink until initialization is complete.
7. If you wish to reassign functions to the SWC, or utilize short press long press dual command functionality, or assign the programmable output to a SWC button, follow the programming instructions on page 11.

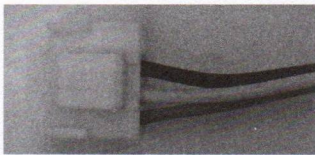

**Interface Connector 1**

Red	Accessory Output (10 amps)
Yellow	12v+
Black	Ground

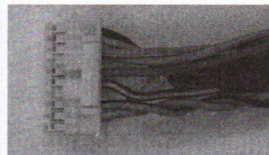

**Interface Connector 2**

3.5mm Jack	SWC Output
Pink	MS-CAN + Input
Pink / Black	MS-CAN - Input
Blue / Yellow	SWC Output
Red / White	12v+ Programmable Output
Orange / White	Illumination Output
Pink	Vehicle Speed Sense Output
Violet / White	Reverse Output
Light Green	Parking Brake Output (-)

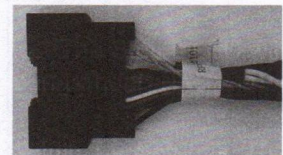

**Vehicle Connector**

Yellow	Battery +12v
Black	Ground
Pink	MS-CAN +
Pink / Black	MS-CAN -
Blue / White	Not Used
Brown	Center CH - Input
Brown / White	Center CH + Input
White	Front L + input
White / Black	Front L - input
Grey	Front R + input
Grey / Black	Front R - input
Green	Rear L + input
Green / Black	Rear L - input
Purple	Rear R + input
Purple / Black	Rear R - input

## VS41 Wiring

**PLEASE NOTE:** Revision 1.0.6.1 of the VS41 is required for this application. If you are adding a front camera and two blind spot cameras, or any combination of the three, to the aftermarket radio, a VS41 is needed (sold separately). Follow the example below to make all inputs work accordingly through the reverse camera input on the aftermarket radio.

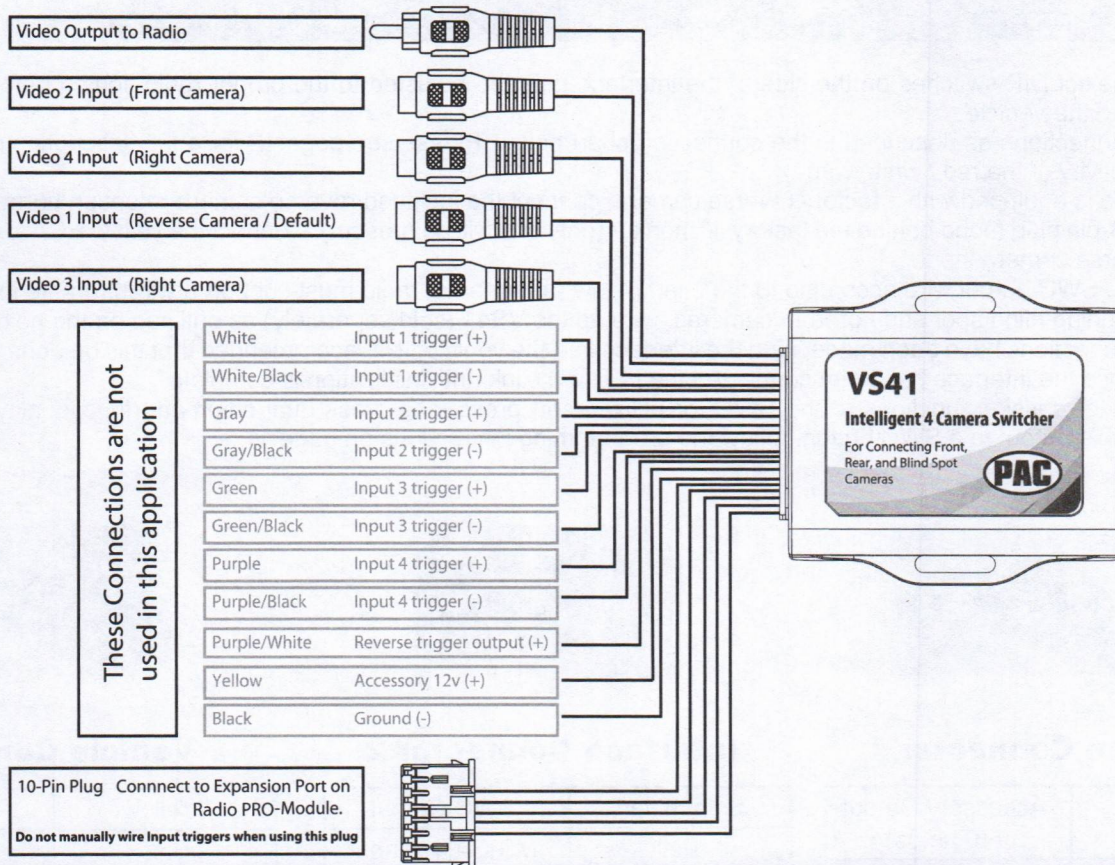

## Steering Wheel Controls

### Default Steering Wheel Control Programming

**IMPORTANT!** The interface comes pre-programmed for all of the vehicles factory SWC functions and does not require programming unless you wish to re-assign the SWC functions, utilize short press long press dual command functionality, or assign the programmable 12v output to a SWC button. The SWC can always be restored to default settings by pressing and releasing the program button on the side of the interface once and waiting 7 seconds for the LED to flash 3 times.

### Default SWC Button Assignments

	Alpine	JVC	Kenwood	Clarion	Pioneer	Sony	Fusion
Volume +	Volume +	Volume +	Volume +	Volume +	Volume +	Volume +	Volume +
Volume -	Volume -	Volume -	Volume -	Volume -	Volume -	Volume -	Volume -
Mode	Source	Source	Source	Source	Source	Source	Source
Track +	Track +	Track +	Track +	Search +	Track +	Track +	Track +
Track -	Track -	Track -	Track -	Search -	Track -	Track -	Track -
Voice	VR	Voicedial	Voice	VR	VR	VR	Power
Mute	Mute	Mute	Att	Mute	Mute	Mute	Mute
Phone Answer	Receive	Answer	Answer	Send	Answer	Answer	N/P
Phone End	End	Reject	End	End	End	Reject	N/P

## Steering Wheel Controls (Cont.)

### Optional Steering Wheel Control Programming

If you wish to re-assign the SWC functions, utilize short press long press dual command functionality, or assign the programmable 12v output to a SWC button, the interface must be programmed in the specific order shown in the chart below. If you come across a function in the chart that your steering wheel does not have, or you do not want to program, press and release the programming button on the side of the interface to skip that function. The LED will flash off and on confirming that you have successfully skipped that function and are ready to proceed to the next one.

#### Short Press Long Press Dual Command Functionality

This feature allows you to assign two aftermarket radio functions to each of the vehicles SWC buttons. It can be used with as many of the buttons as the user likes or none at all. When this functionality is implemented, quickly pressing and releasing a SWC button will initiate the short press command while pressing and holding a SWC button for longer than two seconds will initiate the long press command. Please note that no long press commands are programmed by default. If you wish to assign dual command functionality to the SWC please follow the programming steps below.

#### Programmable 12v Output

The Red / White wire on the interface can be programmed via the RadioPRO app to do a pulsed or latched 12v output which can then be assigned to any of the vehicle's factory SWC buttons. When assigned, the factory SWC button will activate the pulsed or latched output to control external accessories. Please refer to page 12 for more details on how to use the app to set this feature.

### Optional SWC Programming Procedure

1. Turn the key to the ignition position.
2. Press and release programming button on the side of the interface. The Status LED will turn green.
3. Within 7 seconds, press the button that is to be learned on the steering wheel. The LED will turn red when the button is pressed.

#### At this point you have two options:

- A. **For short press functionality:** Release the button within 1.5 seconds. The green LED will turn back on.
  - B. **For long press functionality:** Hold the button until the LED starts blinking. Release the button and the LED will go back to solid green.
4. If you need to program more buttons, repeat step 3 for each additional audio function on the steering wheel.
  5. If you come across a function in the chart that your steering wheel does not have, or you do not want to program, press and release the program button on the side of the interface to skip that function.
  6. Once programming is completed, wait seven seconds. The LED will flash three times indicating end of programming.
  7. Test the interface for proper functionality. Whenever a SWC is pressed the LED on the interface should blink. If any function does not work, repeat the programming steps.

### Optional Programming Order

	Alpine	JVC	Kenwood	Clarion	Other	Pioneer	Sony	Fusion
1	Volume +	Volume +	Volume +	Volume +	Volume +	Volume +	Volume +	Volume +
2	Volume -	Volume -	Volume -	Volume -	Volume -	Volume -	Volume -	Volume -
3	Mute	Mute	Mute	Mute	Mute	Mute	Mute	Mute
4	Preset +	Source	Source	Source	Preset +	Preset +	Preset +	Source
5	Preset -	Track +	Play	Search +	Preset -	Preset -	Preset -	Track +
6	Source	Track -	Track +	Search -	Source	Source	Source	Track -
7	Track +	Band / Disc +	Track -	Band	Track +	Track +	Track +	Audio
8	Track -	Preset / Disc -	Disc / FM +	Send / End	Track -	Track -	Track -	Power
9	Power	Select	Disc / AM -	Send	Band	Band	Band	12v+ Output
10	Enter / Play	Attenuation	Answer	End	Answer	Phone Menu	Reject Call / Source (Bluetooth equipped radios only)	
11	Band / Program	Phone Receive	Voice Dial	VR	END	Answer Call	Answer / End Call	
12	Receive	Phone Reject	On Hook	12v+ Output	PTT	End Call	VR	
13	End	Voice Dial	Off Hook		N/P	VR	12v+ Output	
14	VR	Power	Mute (Multimedia units only)		12v+ Output	12v+ Output		
15	12v+ Output	12v+ Output	Preset +					
16			12v+ Output					

■ - Advent, Boyo, Dual, Lightning Audio, Jensen, Rockford Fosgate & Visteon    ■ - Jensen & Advent ONLY



## Mounting the Aftermarket Radio

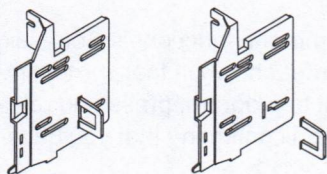

Remove tab (LH & RH) for Double-DIN radio install  
(LH-Side bracket shown)

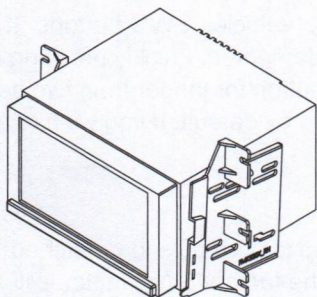

Mount radio to brackets using supplied screws

OR

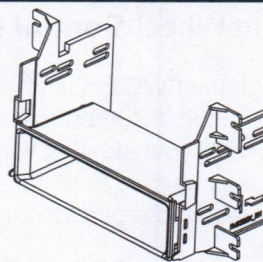

Attach included pocket to bottom of kit brackets

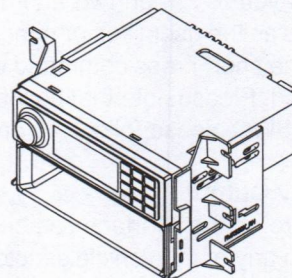

Mount radio to brackets using supplied screws

## Testing and Verification

1. Turn the ignition on. The LED on the interface will turn on and the +12v accessory wire will turn on.
2. Turn on the radio and check balance and fade.
3. Verify that all SWC are functioning properly.
4. Verify that the programmable 12v+ output is functioning as intended (if connected).
5. Verify that all HVAC controls are functioning properly. If the A/C is not blowing cold air, please ensure that the ribbon cables you installed are seated in their connectors properly. Once that is done you may have to drive the vehicle around with the A/C on for up to 20 minutes in order to re-initialize it.
6. The LED & radio will turn off when the ignition is turned off.

## Camera Control

1. If you have the VS41 connected, the cameras can be accessed at any time by using the four buttons you relocated from the factory dash panel. See below for button assignments.
2. If the vehicle is equipped with a factory reverse camera, you can use the first button in the bank of four, or the "Mode" button on the SWC, to switch between wide and narrow view, whenever the vehicle is in reverse. PLEASE NOTE: The wide / narrow switch does not function if the reverse camera has been forced. The vehicle must actually be in reverse for this to function.
3. The default operation of additional cameras is: Blind Spot = on when vehicle moving and turn signal on, Front = Manual Only (using push buttons on HVAC panel). Behavior of these cameras can be changed using the RadioPRO PC application (see next section).

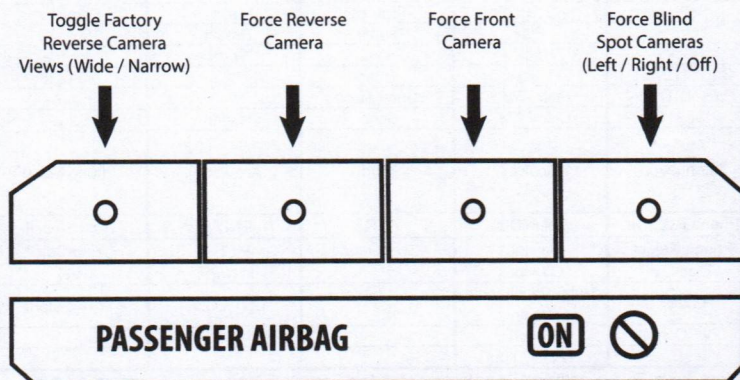

## RadioPRO App

### Use of the RadioPRO App in Ford allows you to do the following:

- Configure User Interface Options such as:
  - Programmable 12v output (Red / White wire) behavior
- Behavior of Front and Blind Spot Cameras (If Present)
- Update Product Firmware
- Read Firmware / Hardware Versions
- Access Product User Manuals

### Programmable 12v Output (Red/White Wire)

The Red / White wire can be programmed to do a pulsed or latched trigger that is controlled by a user assigned steering wheel control button. Select User Interface Options then set the behavior of the Red / White wire using the drop down menu. Restoring factory settings on the module will default this wires output back to a latched SWC trigger.

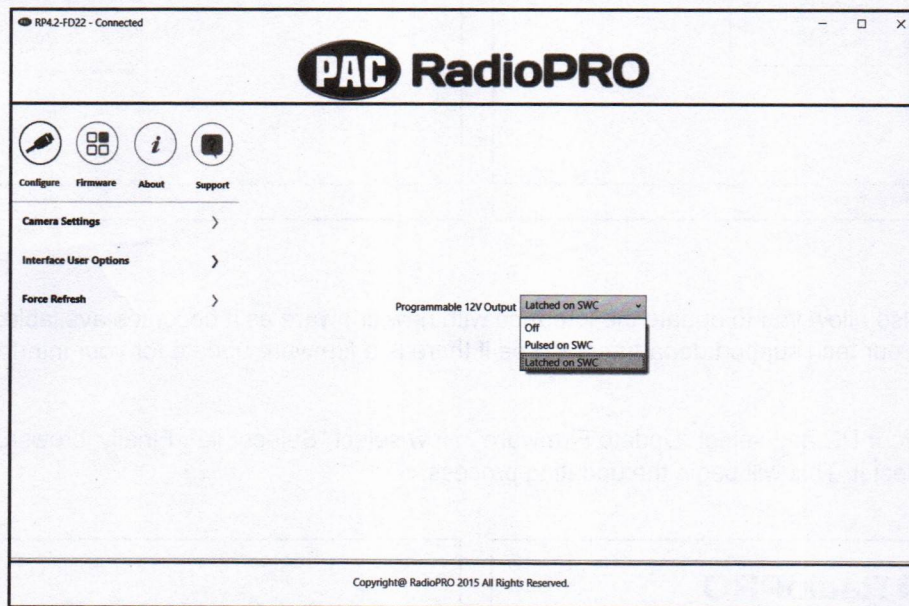

**Latched** - This selection will provide a latched 12v+ output that can be tied to any of the vehicle's SWC. This means that when you press the assigned SWC, the Red / White wire will turn on and remain on until the assigned SWC is pressed again or the ignition is turned off.

**Pulsed** - This selection will provide a user programmable timed 12v+ output that can be tied to any of the vehicle's SWC. This means that when you press the assigned SWC, the Red / White wire will pulse for the pre-programmed user time. The range for pulse time is 100 milliseconds - 25.5 seconds (.1-25.5).

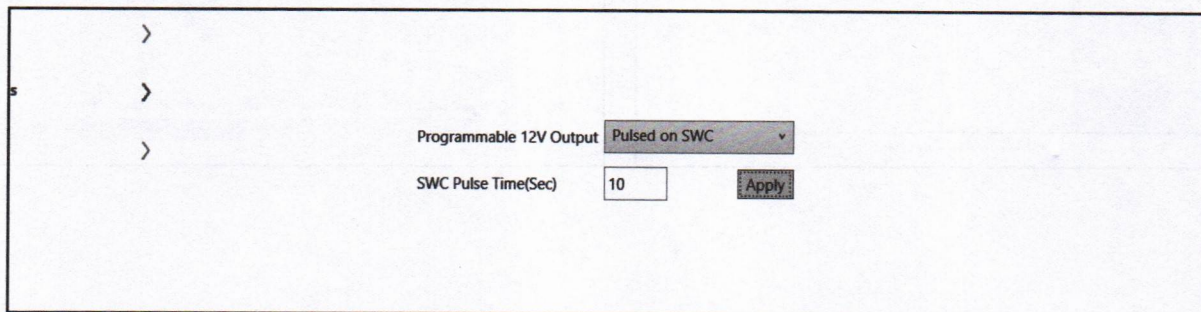

## RadioPRO App (cont.)

### Front and Blind Spot Camera Behavior (VS41 Required)

If you've added front and / or blind spot cameras using the VS41, the behavior of these cameras can be setup using the RadioPRO PC application.

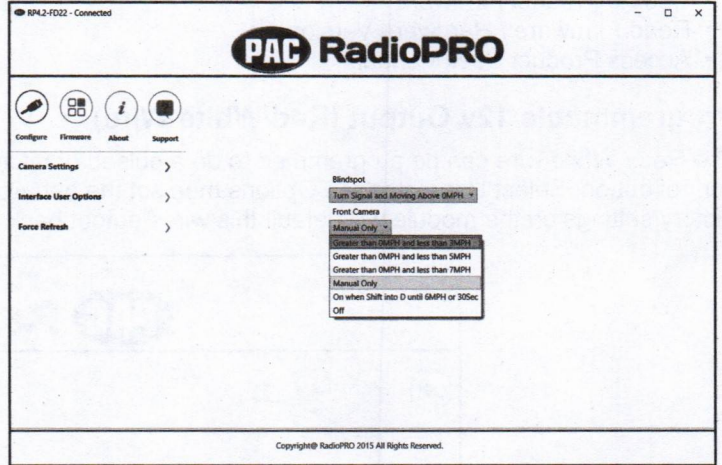
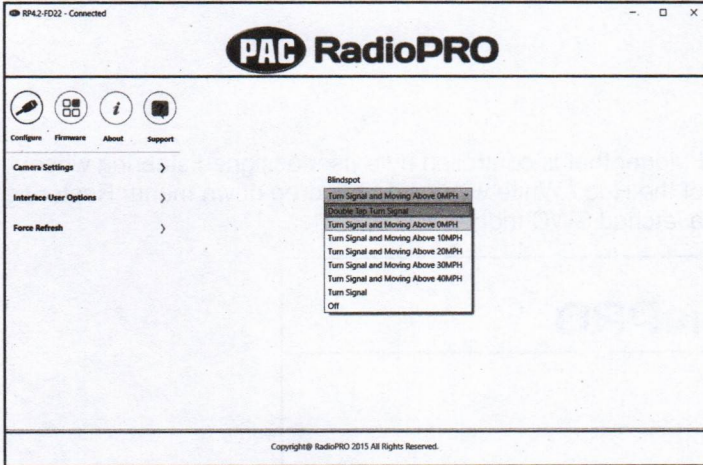

### Firmware Updates

The RadioPRO app will also allow you to update the interface with new firmware as it becomes available. Please visit [www.pac-audio.com](http://www.pac-audio.com) or contact our tech support department to see if there is a firmware update for your interface.

Connect the interface to your PC and select "Update Firmware". Now select "Select File". Finally, browse to the place where you saved the file and select it. This will begin the updating process.

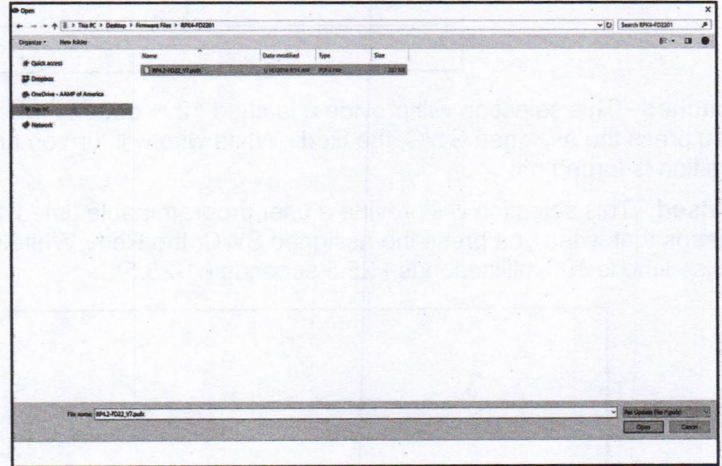
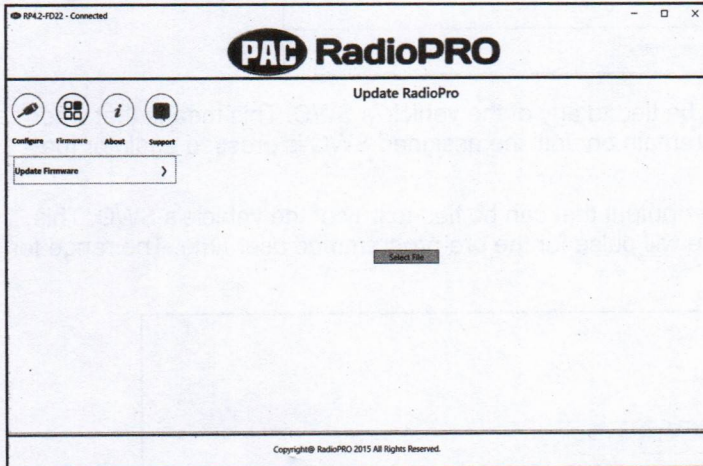

## Restoring Interface Factory Settings

You can restore the interface to factory default settings by pressing and holding the programming button on the side of the module until LED 1 starts blinking red. Once the LED starts blinking red, release the button. You must release the button while the LED is blinking red in order to perform the reset.

This reset will restore the following settings to their factory defaults:

- SWC Mapping
- Programmable 12v+ Output (Latched)
- Front Camera and Blind Spot camera behavior

## Troubleshooting

1. Factory HVAC not working - Please be absolutely CERTAIN that the provided ribbon cables are seated properly and not mis-aligned or installed backwards. Ensure that both HVAC boards are seated properly, and that the alignment tab for the temperature knob is positioned properly according to the steps on Page 6 of this manual.
2. Steering wheel controls inoperable - Ensure that the DIP switches are set properly according to page 9 of this manual.
3. Reverse Camera inoperable - Ensure that the provided reverse camera retention harness is connected to both the vehicle connector (the one behind the factory screen) and the aftermarket radio.
4. Camera view mode switching inoperable - This feature is not retained by the RPK4.2-FD2201.

LED Pattern	State	Action
LED 1 solid red	Active	N/A
LED 1 flashing green	SWC Activity	N/A
LED 2 solid red	Programmable 12v output active	N/A
LED 1 flashing red	Resetting	N/A
LED 2 flashing amber	USB connected	N/A
Off	No activity	Ensure Key is in ignition position. If so, verify that there is 12v and ground on the yellow and black wires.