

7929 Lincoln Ave. Riverside, CA 92504  
Phone: 951.689.ICON | Fax: 951.689.1016

PART #	DESCRIPTION
64013	23 FORD F-250/F-350 FRONT 4.5" DIESEL DUAL RATE SPRING KIT

COMPONENTS INCLUDED	
(2) 168521 20+ FSD 4.5" LIFT DUAL RATE COIL SPRINGS	
HARDWARE INCLUDED	
N/A	
TOOLS REQUIRED	
JACK JACK STANDS PLIERS TORQUE WRENCH HAMMER BALL JOINT SEPARATOR	SPRING COMPRESSOR 3/4" SOCKET / WRENCH 13MM SOCKET / WRENCH 18MM SOCKET / WRENCH 21MM SOCKET / WRENCH 30MM SOCKET / WRENCH
TECH NOTES	
<p>1. LIFT HEIGHTS ARE BASED ON CREW CAB GAS ENGINE F-250 CONFIGURATIONS.</p> <p>2. ICON 4.5" COIL SPRINGS MUST BE INSTALLED IN CONJUNCTION WITH AN ICON 4.5" RADIUS ARM OR 4-LINK KIT.</p> <p>3. ESTIMATED INSTALL TIME: 2 HOURS</p>	



**WARNING!**

**\*\* READ ALL INSTRUCTIONS THOROUGHLY FROM START TO FINISH BEFORE BEGINNING INSTALLATION! IF THESE INSTRUCTIONS ARE NOT PROPERLY FOLLOWED SEVERE FRAME, SUSPENSION AND TIRE DAMAGE MAY RESULT TO THE VEHICLE!**

**\*\* ICON VEHICLE DYNAMICS RECOMMENDS THAT YOU EXERCISE EXTREME CAUTION WHEN WORKING UNDER A VEHICLE THAT IS SUPPORTED WITH JACK STANDS.**

**\*\* ICON VEHICLE DYNAMICS RECOMMENDS ALL INSTALLATION TO BE PERFORMED BY A PROFESSIONAL SHOP/SERVICE TECHNICIAN. PRODUCT FAILURE CAUSED BY IMPROPER INSTALLATION WILL NOT BE COVERED UNDER ICON'S WARRANTY POLICY.**

## INSTALLATION

- Using a properly rated jack, raise the front of the vehicle and support the frame rails with jack stands. Ensure the jack stands are secure and set properly before lowering the jack. NEVER WORK UNDER AN UNSUPPORTED VEHICLE. Remove front wheels.
- Remove the sway bar links from the sway bar using an 18mm socket/wrench. Leave them connected to the differential. [FIGURE 1]

FIG.1

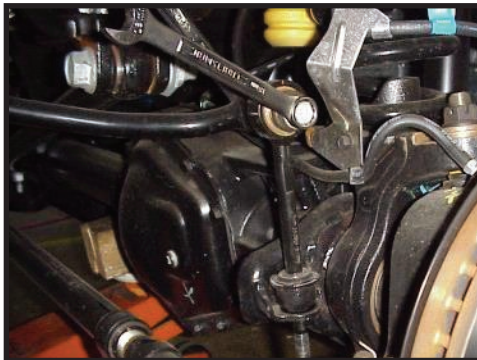

FIG.2



- Disconnect the upper brake line brackets from the frame using a 13mm socket/wrench and lower brake line brackets from the differential using a 10mm socket/wrench. [FIGURE 2]

- 4.** On the driver side of the track bar, remove the nut and the upper track bar bolt using (2) 30mm socket/wrenches. **[FIGURE 3]**

**FIG.3**

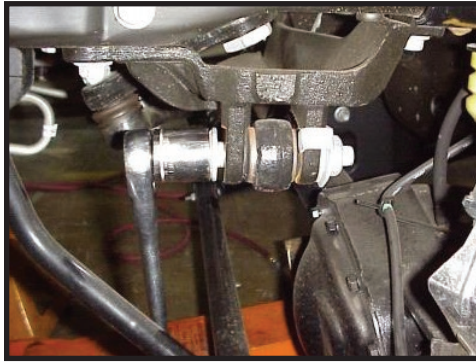

- 5.** Support the axle with a floor jack and remove the front shocks. The shocks are limiting droop so make sure that the axle is supported or it will fall when the shocks are removed (21mm socket/wrench, 18mm socket/wrench).
- 6.** Slowly lower the axle, the coils will unload from the mounts and can be removed. Be careful not to stretch or damage any lines connected to the axle or radius arms. On 2017-UP models, removing the drag link from the pitman arm may be required. A spring compressor can be used if available, so the axle does not need to be drooped out so far.
- 7.** Lower the axle just enough to install the new springs. Place the original rubber isolator on top of the new coil and install. Be careful to not stretch or damage any lines. Check the rotation/clocking of the coil to make sure it is properly seated in the lower spring perch.
- 8.** Lift the axle high enough to connect the shocks but be careful not to lift the truck off of its supports. Use the original bolt on the lower shock mount and tighten with an 18mm socket/wrench [Torque to factory spec]. Tighten the stem top nut using a 3/4" socket/wrench. (Refer to shock instructions)
- 9.** Connect the sway bar links to the sway bar using an 18mm socket/wrench. [Torque to factory spec]
- 10.** Reconnect the upper brake line bracket to the frame using a 13mm socket/wrench and the lower bracket using a 10mm socket/wrench [Torque to factory spec]. Depending on the truck, the brake line may need to be manipulated down to not overextend at full droop.
- 11.** Reconnect the track bar using (2) 30mm socket/wrenches [Torque to factory spec]. If drag link was removed in step 6, lift axle to ride height and reinstall. [Torque to factory spec]
- 12.** Install the wheels and lower the vehicle to the ground.
- 13.** Have the vehicle professionally aligned.

***VERIFY ALL FASTENERS ARE PROPERLY TORQUED BEFORE DRIVING VEHICLE.***

***RETORQUE ALL NUTS, BOLTS AND LUGS AFTER 100 MILES AND PERIODICALLY THEREAFTER.***

## ICON VEHICLE DYNAMICS LIMITED LIFETIME WARRANTY

ICON Vehicle Dynamics warrants to the original retail purchaser who owns the vehicle on which the product was originally installed. ICON Vehicle Dynamics does not warrant the product for finish, alterations, modifications and/or installation contrary to ICON Vehicle Dynamics instructions. ICON Vehicle Dynamics products are not designed, nor are they intended to be installed on vehicles used in race applications, for racing purposes or for similar activities. (A "race" is defined as any contest between two or more vehicles, or a contest of one or more vehicles against the clock, whether or not such contest is for a prize). This warranty does not include coverage for police or taxi vehicles, race vehicles, or vehicles used for government or commercial purposes. Also excluded from this warranty are sales outside of the United States of America and Canada.

ICON Vehicle Dynamics' obligation under this warranty is limited to the repair or replacement, at ICON Vehicle Dynamics' discretion, of the defective product. Any and all costs of removal, installation or re-installation, freight charges and incidental or consequential damages are expressly excluded from this warranty. Items that are subject to wear are not considered defective when worn and are not covered.

ICON Vehicle Dynamics components must be installed as a complete kit as shown in our current application guide. Any substitutions or exemptions of required components will immediately void the warranty. Some finish damage may happen to parts during shipping and is not covered under warranty.

This warranty is expressly in lieu of all other warranties expressed or implied. This warranty shall not apply to any product that has been improperly installed, modified or customized subject to accident, negligence, abuse or misuse.



**ICON VEHICLE DYNAMICS®**  
PERFORMANCE SUSPENSION SYSTEMS AND SHOCK ABSORBERS

7929 Lincoln Ave. Riverside, CA 92504 Phone: 951.689.ICON Fax: 951.689.1016  
[www.iconvehicledynamics.com](http://www.iconvehicledynamics.com)



**FOLLOW US ON FACEBOOK!**



7929 Lincoln Ave. Riverside, CA 92504  
Phone: 951.689.ICON | Fax: 951.689.1016

PART #	DESCRIPTION
64039	08-UP FSD TRACK BAR BUMP STEER BRACKET KIT

COMPONENTS INCLUDED	
(1) 164045 08-UP FSD TRACK BAR BUMP STEER BRACKET (2) 167032 08-UP FSD TRACK BAR BUMP STEER CAM	(2) 167031 05+ FSD 1" BUMP STOP SPACER
HARDWARE INCLUDED	
(2) 605802 M8-1.25 X 40MM HEX HEAD BOLT	
TOOLS REQUIRED	
JACK JACK STANDS TORQUE WRENCH RATCHET BLUE THREAD LOCKER	10MM SOCKET/WRENCH 13MM SOCKET/WRENCH 18MM SOCKET/WRENCH 21MM SOCKET/WRENCH 30MM SOCKET/WRENCH
TECH NOTES	
<p>1. BUMP STEER CORRECTION IS INTENDED FOR 2.5" OR 4.5" LIFTS WITH THE USE OF THE FACTORY TRACK BAR OR ICON TRACK BAR SET TO THE FACTORY LENGTH.</p> <p>2. DEPENDING ON SUSPENSION SYSTEM THAT YOU PURCHASED, YOU MAY END UP WITH MORE THAN ONE SET OF FRONT BUMP STOP SPACERS. INSTALL THE TALLEST OF THE SUPPLIED FRONT BUMP STOP SPACERS WITH THIS BRACKET.</p>	

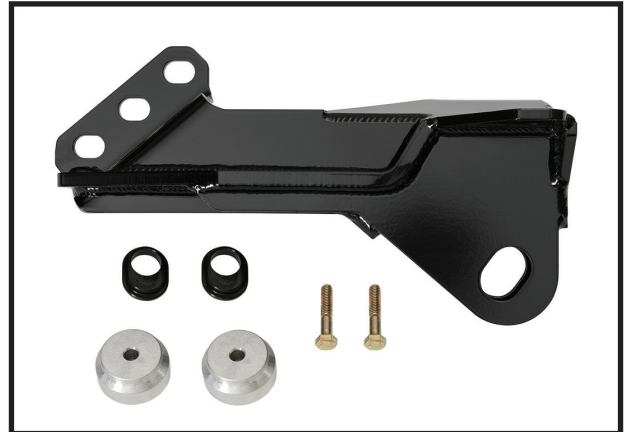

WARNING!
<p>** READ ALL INSTRUCTIONS THOROUGHLY FROM START TO FINISH BEFORE BEGINNING INSTALLATION! IF THESE INSTRUCTIONS ARE NOT PROPERLY FOLLOWED SEVERE FRAME, SUSPENSION AND TIRE DAMAGE MAY RESULT TO THE VEHICLE!</p> <p>** ICON VEHICLE DYNAMICS RECOMMENDS THAT YOU EXERCISE EXTREME CAUTION WHEN WORKING UNDER A VEHICLE THAT IS SUPPORTED WITH JACK STANDS.</p> <p>** ICON VEHICLE DYNAMICS RECOMMENDS ALL INSTALLATION TO BE PERFORMED BY A PROFESSIONAL SHOP/SERVICE TECHNICIAN. PRODUCT FAILURE CAUSED BY IMPROPER INSTALLATION WILL NOT BE COVERED UNDER ICON'S WARRANTY POLICY.</p>

## INSTALLATION

- Using a properly rated jack, raise the front of the vehicle and support the frame rails with jack stands. Ensure the jack stands are secure and set properly before lowering the jack. Never work under an unsupported vehicle. Remove the front wheels and tires.
- Disconnect the track bar from the factory frame bracket using a 30mm wrench/socket. [FIGURE 1]

FIG.1



FIG.2

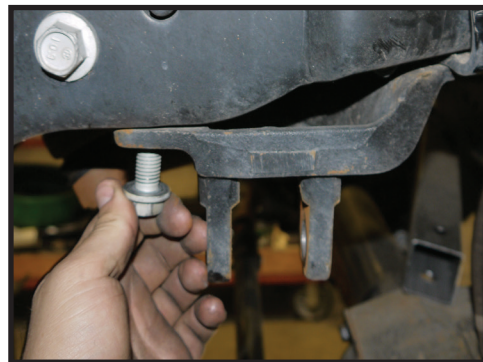

- Remove the stock track bar bracket: Remove the (2) bolts going up into the bottom of the frame rail using an 18mm and the (3) nuts on the engine crossmember using a 21mm. Remove the stud plate from the crossmember and remove the track bar bracket. [FIGURE 2]

**4.** Install the new track bar bracket using the factory hardware. Hold the bracket up to position and insert the stud plate through the crossmember and bracket. Use a small amount of blue thread locker on the threads and install the (3) nuts loosely. [FIGURE 3]



FIG.3

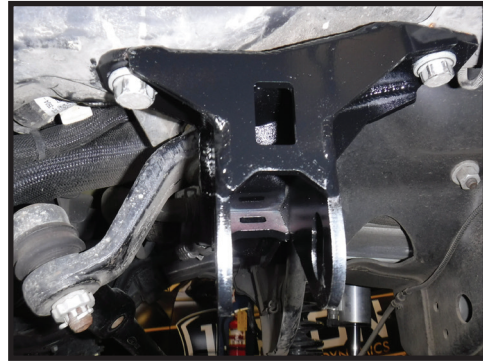

FIG.4

**5.** Apply a small amount of thread locker on the frame bolts and install them. There are nut plates inside the frame that stick out of the holes on the inside. Hold the nut plates in place to assist with threading the bolts in. [Torque to factory spec] [FIGURE 4]

**6.** If bracket is being installed along with the ICON's 4.5" box kit (64050) refer to those instructions now.

**7.** Install the track bar into place. Be sure that the adjustment cam is in the correct position for the lift kit being installed: 2.5" lifts require the cam to be positioned so that the hole is offset to the highest position. 4.5" lifts require the cam to be positioned so that the hole is offset to the lowest position. [FIGURE 5]

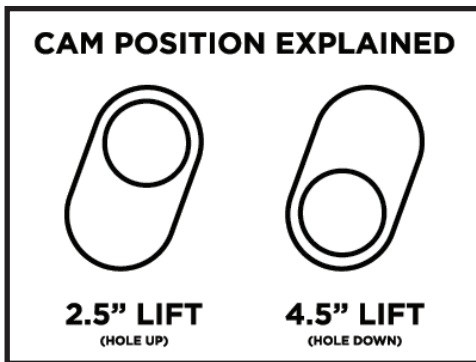

FIG.5



FIG.6

**8.** Use a small amount of thread locker on the bolt and nut then torque to factory spec. You may need to raise or lower the axle with a jack to align the track bar with the mounting holes (4.5" POSITION SHOWN). [FIGURE 6]

**9.** Pry the front bump stops out of the bump stop cups then remove the bolt in the center of the cup using a 10mm.

**10.** Install the new bump stop spacer between the factory cup and frame using the supplied bolt. Rotate the cup so the flat side is nearest to the coil for added clearance. (REFER TO TECH NOTES BEFORE INSTALLING THE BUMP STOP SPACER) [Torque to factory spec] [FIGURE 7]



FIG.7

**11.** Push the bump stops back into the cups until they snap/lock into place.

**12.** Reinstall the wheels and lower the vehicle to the ground. [Torque lug nuts to factory spec]

**13.** Have the vehicle professionally aligned.

**VERIFY ALL FASTENERS ARE PROPERLY TORQUED BEFORE DRIVING VEHICLE.**

**RETORQUE ALL NUTS, BOLTS AND LUGS AFTER 100 MILES AND PERIODICALLY THEREAFTER.**

## ICON VEHICLE DYNAMICS LIMITED LIFETIME WARRANTY

ICON Vehicle Dynamics warrants to the original retail purchaser who owns the vehicle on which the product was originally installed. ICON Vehicle Dynamics does not warrant the product for finish, alterations, modifications and/or installation contrary to ICON Vehicle Dynamics instructions. ICON Vehicle Dynamics products are not designed, nor are they intended to be installed on vehicles used in race applications, for racing purposes or for similar activities. (A "race" is defined as any contest between two or more vehicles, or a contest of one or more vehicles against the clock, whether or not such contest is for a prize). This warranty does not include coverage for police or taxi vehicles, race vehicles, or vehicles used for government or commercial purposes. Also excluded from this warranty are sales outside of the United States of America and Canada.

ICON Vehicle Dynamics' obligation under this warranty is limited to the repair or replacement, at ICON Vehicle Dynamics' discretion, of the defective product. Any and all costs of removal, installation or re-installation, freight charges and incidental or consequential damages are expressly excluded from this warranty. Items that are subject to wear are not considered defective when worn and are not covered.

ICON Vehicle Dynamics components must be installed as a complete kit as shown in our current application guide. Any substitutions or exemptions of required components will immediately void the warranty. Some finish damage may happen to parts during shipping and is not covered under warranty.

This warranty is expressly in lieu of all other warranties expressed or implied. This warranty shall not apply to any product that has been improperly installed, modified or customized subject to accident, negligence, abuse or misuse.

## ICON VEHICLE DYNAMICS LIABILITY DISCLAIMER

ICON does not make any representations or warranties regarding the fitness of any ICON product for a particular installation or conformance of any ICON product with a particular vehicle application. Installation of any ICON suspension system is at the sole discretion of the end user and in making a purchase of any ICON suspension system, the purchaser assumes the responsibility and liability for any and all damage or injury, of any kind or nature whatsoever, caused by, resulting from, arising out of, or occurring in connection with the use or installation of any ICON suspension system. ICON is not liable for and specifically disavows any installation that is not in conformance with original equipment manufacturer's recommendations or instructions. Purchaser agrees that in the event of any claim or lawsuit arising out of the installation or use of an ICON suspension system, purchaser shall indemnify and hold harmless ICON, its agents, employees, officers and owners from and against any and all loss, expense, damage or injury that ICON may sustain as the result of such claim. [If applicable, ICON defers to and recommends recalibration of any/all vehicle stability systems after suspension installation.]



**ICON VEHICLE DYNAMICS®**  
PERFORMANCE SUSPENSION SYSTEMS AND SHOCK ABSORBERS

7929 Lincoln Ave. Riverside, CA 92504 Phone: 951.689.ICON Fax: 951.689.1016  
[www.iconvehicledynamics.com](http://www.iconvehicledynamics.com)



**FOLLOW US ON FACEBOOK!**



7929 Lincoln Ave. Riverside, CA 92504  
Phone: 951.689.ICON | Fax: 951.689.1016

PART #	DESCRIPTION
64046	23 FSD RADIUS ARM DROP KIT

COMPONENTS INCLUDED	
(1) 164051 23 FSD RADIUS ARM DROP (DRVR) (1) 164052 23 FSD RADIUS ARM DROP (PASS)	(1) 64046H 23 FSD RADIUS ARM DROP HARDWARE KIT
HARDWARE INCLUDED	
64046H HARDWARE KIT?	
(4) 167029 SLEEVE 1.500 X .525 X .625 RAW (2) 605202 7/16-14 X 1.250 HHCS GR8 YZINC (2) 605220 7/16-14 NYLOCK NUT GR8 YZINC (4) 605230 7/16 SAE FLAT WASHER GR8 YZINC (8) 605357 WASHER 1.500 X .531 X .046 CZINC (2) 605518 5/8-11 X 1.500 HHCS GR8 YZINC (2) 605527 5/8 SPLIT LOCK WASHER GR8 YZINC (2) 605601 3/4-10 X 5.500 HHCS GR8 YZINC (2) 605620 3/4-10 NYLOCK NUT GR8 YZINC	(4) 605630 3/4 SAE FLAT WASHER GR8 YZINC (2) 605823 M12-1.75 NYLOCK NUT GR8.8 CZINC (2) 605849 M12-1.75 X 180MM HHCS GR10.9 YZINC (2) 605821 M18 - 2.5 NYLOCK NUT GR8.8 CZINC (2) 605831 M18-2.5 X 139.3 OAL OEM FORD BOLT (2) 605832 M18 FLAT WASHER GR 10.9 YZINC
TOOLS REQUIRED	
JACK JACK STANDS TORQUE WRENCH 8MM SOCKET / WRENCH 10MM SOCKET / WRENCH 13MM SOCKET / WRENCH 15MM SOCKET / WRENCH 18MM SOCKET / WRENCH 19MM SOCKET / WRENCH	24MM SOCKET / WRENCH 27MM SOCKET / WRENCH 30MM SOCKET / WRENCH 3/8" 12PT SOCKET / WRENCH 1/2" SOCKET / WRENCH 15/16" SOCKET / WRENCH 1 1/16" SOCKET / WRENCH 1 1/8" SOCKET / WRENCH
TECH NOTES	
N/A	



WARNING!
<p><b>** READ ALL INSTRUCTIONS THOROUGHLY FROM START TO FINISH BEFORE BEGINNING INSTALLATION! IF THESE INSTRUCTIONS ARE NOT PROPERLY FOLLOWED SEVERE FRAME, SUSPENSION AND TIRE DAMAGE MAY RESULT TO THE VEHICLE!</b></p> <p><b>** ICON VEHICLE DYNAMICS RECOMMENDS THAT YOU EXERCISE EXTREME CAUTION WHEN WORKING UNDER A VEHICLE THAT IS SUPPORTED WITH JACK STANDS.</b></p> <p><b>** ICON VEHICLE DYNAMICS RECOMMENDS ALL INSTALLTION TO BE PERFORMED BY A PROFESSIONAL SHOP/SERVICE TECHNICIAN. PRODUCT FAILURE CAUSED BY IMPROPER INSTALLATION WILL NOT BE COVERED UNDER ICON'S WARRANTY POLICY.</b></p>

## INSTALLATION

**1.** Using a properly rated jack, raise the front end of the vehicle and support the frame rails with jack stands. The best positions to support the front of the truck are either the frame rails just behind the front bumper or on the body mounts just behind the front fenders. If lifting from the body mounts, be careful not to pinch the parking brake line on the driver's side. NEVER WORK UNDER AN UNSUPPORTED VEHICLE. Remove the front wheels.

**2.** Remove the sway bar links from the sway bar using an 18mm & 8mm. Leave them connected at the axle end. [FIGURE 1]

FIG.1

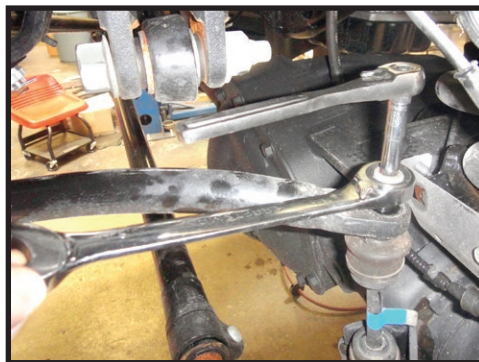

FIG.2



**3.** Disconnect the upper brake line brackets from the frame using a 13mm and lower brake line brackets from the axle using a 10mm. [FIGURE 2]

4. Remove the factory track bar using a 27mm and 30mm. (Refer to track bar #64038 instructions) [FIGURE 3]

FIG.3



5. Support the axle using a jack and remove the front shocks. The shocks are limiting droop so make sure that the axle is well supported or it will fall when the shocks are removed. Only remove the lower bolt using an 18mm.

6. Slowly lower the axle until the coils unload from the mounts. Be careful not to stretch or damage any lines connected to the differential or radius arms. Remove the coils. [FIGURE 4]

FIG.4



7. Some trucks have a transfer case skid plate that must be removed first using a 15mm. Remove the nut clips from the frame.

8. Lift the axle enough to reconnect the shocks and then lower the axle back down. [FIGURE 5]

FIG.5

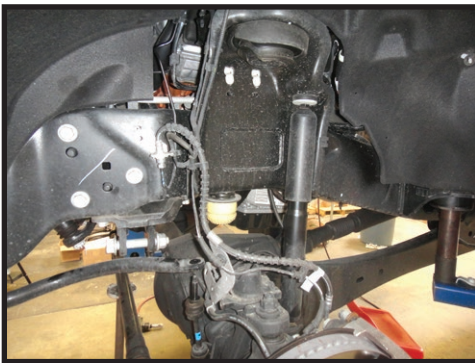

FIG.6



9. With both coils removed, the radius arms don't have much force on them and can be safely removed from the frame mount using a 24mm & 27mm. [FIGURE 6]

10. Once the bolts are removed from the radius arms, lift up on the tie rod to rotate the axle rearward which will then rotate the radius arms out of their pockets. [FIGURE 7]

FIG.7



FIG.8



11. Remove the outside crossmember bolt on both sides. [FIGURE 8]

**12.** Position the driver side radius arm bracket into the radius arm pocket. Loosely install the supplied M18 X 139mm bolt with washers in the forward hole. Loosely install the supplied rear 3/4" X 5.5" bolt with washers into the radius arm holes. [FIGURE 9]



FIG.9

**13.** Spacers, washers, and a longer 12mm bolt are supplied to mount the radius arm bracket to the crossmember using a 19mm. The washers are used to account for the variances in crossmember placement in relation to the radius arm pockets. Position the supplied spacers and washers between the crossmember and radius arm bracket. One spacer must go on the driver and passenger (also front and rear) sides of the crossmember. Position the shims as needed. Four shims must be used on each side of the truck. The shim positioning may vary from one side to the other. [Torque to 65 ft-lbs] [FIGURE 10 & 11]



FIG.10



FIG.11

**14.** Next drill out the forward hole in the frame using a 7/16" drill bit. A step drill bit can be easier if available. Then install the supplied 7/16-14 hardware and torque to 50 ft-lbs [FIGURE 12].



FIG.12

**15.** With both of the frame brackets installed loosely on the vehicle, torque the M18 bolts/nuts to 250 ft-lbs.

**16.** Insert the supplied 5/8" bolt with washer and split washer inside the cross member and torque to 150 ft-lbs. [FIGURE 13]

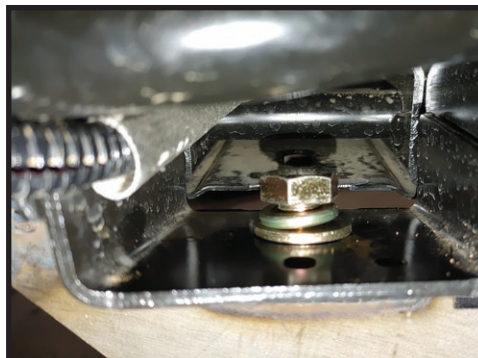
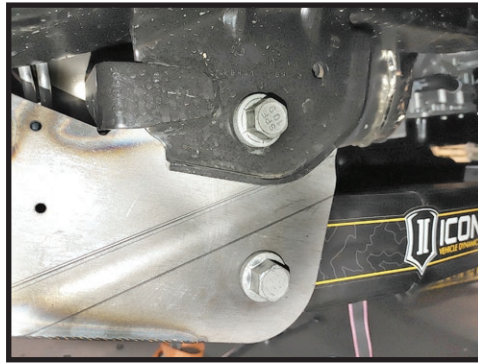

FIG.13

**17.** Move the radius arms up into the pockets of the drop bracket and fasten with the factory bolt using a 24mm & 27mm. [Torque to factory spec] [FIGURE 14]

FIG.14



**18.** Remove the shocks and lower the axle enough to install the coil springs.

**19.** Once the coils are in seated, install the shocks using an 18mm and 19mm. Be careful not to lift the truck off of its supports. [Torque to factory spec] [FIGURE 15]

FIG.15



FIG.16

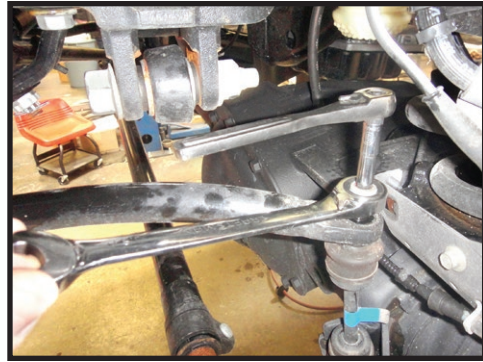

**20.** Reconnect the sway bar links to the sway bar using an 8mm and 18mm. [Torque to factory spec] [FIGURE 16]

**21.** Install the ICON adjustable track bar (64038) using a 30mm. (Refer to track bar instructions) [FIGURE 17]

FIG.17



**22.** Install the extended brake line kit (61110) available from ICON.

**23.** Mount the lower brake line brackets using the factory bolt and a 10mm. [Torque to factory spec] [FIGURE 18]

FIG.18



- 24.** Install the wheels/tires and lower the vehicle to the ground. [Torque lugs to factory spec]
- 25.** Center the front axle under the truck using the adjustable track bar. Center the steering wheel. Refer to track bar instructions.
- 26.** Have the vehicle professionally aligned.

***VERIFY ALL FASTENERS ARE PROPERLY TORQUED BEFORE DRIVING VEHICLE.***

***RETORQUE ALL NUTS, BOLTS AND LUGS AFTER 100 MILES AND PERIODICALLY THEREAFTER.***

### ***ICON VEHICLE DYNAMICS LIMITED LIFETIME WARRANTY***

ICON Vehicle Dynamics warrants to the original retail purchaser who owns the vehicle on which the product was originally installed. ICON Vehicle Dynamics does not warrant the product for finish, alterations, modifications and/or installation contrary to ICON Vehicle Dynamics instructions. ICON Vehicle Dynamics products are not designed, nor are they intended to be installed on vehicles used in race applications, for racing purposes or for similar activities. (A "race" is defined as any contest between two or more vehicles, or a contest of one or more vehicles against the clock, whether or not such contest is for a prize). This warranty does not include coverage for police or taxi vehicles, race vehicles, or vehicles used for government or commercial purposes. Also excluded from this warranty are sales outside of the United States of America and Canada.

ICON Vehicle Dynamics' obligation under this warranty is limited to the repair or replacement, at ICON Vehicle Dynamics' discretion, of the defective product. Any and all costs of removal, installation or re-installation, freight charges and incidental or consequential damages are expressly excluded from this warranty. Items that are subject to wear are not considered defective when worn and are not covered.

ICON Vehicle Dynamics components must be installed as a complete kit as shown in our current application guide. Any substitutions or exemptions of required components will immediately void the warranty. Some finish damage may happen to parts during shipping and is not covered under warranty.

This warranty is expressly in lieu of all other warranties expressed or implied. This warranty shall not apply to any product that has been improperly installed, modified or customized subject to accident, negligence, abuse or misuse.

## **ICON VEHICLE DYNAMICS**

PERFORMANCE SUSPENSION SYSTEMS AND SHOCK ABSORBERS

7929 Lincoln Ave. Riverside, CA 92504 Phone: 951.689.ICON Fax: 951.689.1016  
[www.iconvehicledynamics.com](http://www.iconvehicledynamics.com)



**FOLLOW US ON FACEBOOK!**



7929 Lincoln Ave. Riverside, CA 92504  
 Phone: 951.689.ICON Fax: 951.689.1016

PART #	DESCRIPTION
66516	17-UP FSD 4WD 0-2" REAR 2.0 VS IR

COMPONENTS INCLUDED	
(1) 164917 17-UP FSD 4WD 0-2" REAR 2.0 VS IR	
HARDWARE INCLUDED	
N/A	
TOOLS REQUIRED	
JACK JACK STANDS TORQUE WRENCH	18MM SOCKET / WRENCH 21MM SOCKET / WRENCH
TECH NOTES	
<p>1. YOUR ICON SHOCK ASSEMBLIES COME FACTORY CHARGED TO 180 PSI. RELEASING NITROGEN PRESSURE MAY LEAD TO SHOCK MALFUNCTION AND REDUCED RIDE QUALITY. FAILURE CAUSED BY LOW NITROGEN PRESSURE IS NOT COVERED UNDER ICON'S WARRANTY POLICY.</p>	



WARNING!
<p><b>** READ ALL INSTRUCTIONS THOROUGHLY FROM START TO FINISH BEFORE BEGINNING INSTALLATION! IF THESE INSTRUCTIONS ARE NOT PROPERLY FOLLOWED SEVERE FRAME, SUSPENSION AND TIRE DAMAGE MAY RESULT TO THE VEHICLE!</b></p> <p><b>** ICON VEHICLE DYNAMICS RECOMMENDS THAT YOU EXERCISE EXTREME CAUTION WHEN WORKING UNDER A VEHICLE THAT IS SUPPORTED WITH JACK STANDS.</b></p> <p><b>** ICON VEHICLE DYNAMICS RECOMMENDS ALL INSTALLTION TO BE PERFORMED BY A PROFESSIONAL SHOP/SERVICE TECHNICIAN. PRODUCT FAILURE CAUSED BY IMPROPER INSTALLATION WILL NOT BE COVERED UNDER ICON'S WARRANTY POLICY.</b></p>

## INSTALLATION

- Using a properly rated jack, raise the front of the vehicle and support the frame rails with jack stands. Ensure the jack stands are secure and set properly before lowering the jack. NEVER WORK UNDER AN UNSUPPORTED VEHICLE.
- Remove the factory shocks using 18mm and 21mm socket/wrenchS.
- Slide the shock into the upper shock mount and fasten using an 18mm with the factory hardware. [Torque to factory spec]
- Position the rod end in the lower mount and slide the bolt in. Fasten using an 18mm and 21mm with the factory hardware. [Torque to factory spec]
- Lower the vehicle back to the ground.

**VERIFY ALL FASTENERS ARE PROPERLY TORQUED BEFORE DRIVING VEHICLE.**

**RETORQUE ALL NUTS, BOLTS AND LUGS AFTER 100 MILES AND PERIODICALLY THEREAFTER.**

## 2.0 ALUMINUM SERIES TECHNICAL INFORMATION

### MAINTENANCE

ICON shock absorbers are a high quality rebuildable race style shock absorber designed for optimal performance. With a unit of this caliber on your vehicle, routine maintenance is required to keep them looking and operating in like new condition. Residual oil and assembly lube may be present at all seal paths from the factory out of the box and is considered normal. Pooling of oil however is not acceptable at any time and one should contact the ICON dealer where purchased.

**BELOW ARE GUIDELINES BASED ON HOW YOU USE YOUR VEHICLE BUT YOUR MILEAGE MAY VARY:**

#### **STREET USE:**

- Send in for factory servicing every 40,000 miles or if a leak develops, ride quality decreases, or they begin to make excessive noise.
- Remove any buildup of road salt, mud, or debris from shocks anytime accrued
- Clean with mild soap and water with each oil change or anytime you notice build up.
- Wax the cylinders yearly with automotive wax to prevent corrosion.
- Check nitrogen pressure yearly. (252004 charge needle assembly available at any ICON distributor)

#### **STREET/DIRT:**

- Send in for factory servicing every 15,000 miles or if a leak develops, ride quality decreases, or they begin to make excessive noise.
- Clean with mild soap and water with each oil change, offroad trip, or anytime you notice build up.
- Wax the cylinders yearly with automotive wax to prevent corrosion.
- Check nitrogen pressure each dirt outing. (252004 charge needle assembly available at any ICON distributor)

#### **DIRT USE:**

- Send in for factory servicing every 1,000 miles.
- Check nitrogen pressure each outing. (252004 charge needle assembly available at any ICON distributor)
- Remove any buildup of mud or debris from shocks after every outing.

#### **SELF-SERVICE:**

- Contact ICON for service kits & tools at (951) 689-4266.

### PRODUCT REGISTRATION

Please visit: <http://www.iconvehicledynamics.com/tech-support/registration/> to register your product.

### ICON VEHICLE DYNAMICS SHOCK ABSORBER WARRANTY

This shock absorber has a 1 year warranty against any manufacturer's defects. If a shock fails within the initial year of ownership, the shock must be shipped to ICON Vehicle Dynamics for inspection and service. If a shock is inspected and it has been determined the shock failed due to neglect, damage caused by improper installation or any other reason besides "normal wear and tear", the owner of said shock is responsible for all service costs. This includes labor, parts, and shipping.

ICON Vehicle Dynamics warrants to the original retail purchaser who owns the vehicle on which the product was originally installed. ICON Vehicle Dynamics does not warrant the product for finish, alterations, modifications and/or installation contrary to ICON Vehicle Dynamics instructions. ICON Vehicle Dynamics products are not designed, nor are they intended to be installed on vehicles used in race applications, for racing purposes or for similar activities. (A "race" is defined as any contest between two or more vehicles, or a contest of one or more vehicles against the clock, whether or not such contest is for a prize). This warranty does not include coverage for police or taxi vehicles, race vehicles, or vehicles used for government or commercial purposes. Also excluded from this warranty are sales outside of the United States of America and Canada.

ICON Vehicle Dynamics' obligation under this warranty is limited to the repair or replacement, at ICON Vehicle Dynamics' discretion, of the defective product. Any and all costs of removal, installation or re-installation, freight charges and incidental or consequential damages are expressly excluded from this warranty. Items that are subject to wear are not considered defective when worn and are not covered.

ICON Vehicle Dynamics components must be installed as a complete kit as shown in our current application guide. Any substitutions or exemptions of required components will immediately void the warranty. Some finish damage may happen to parts during shipping and is not covered under warranty.

This warranty is expressly in lieu of all other warranties expressed or implied. This warranty shall not apply to any product that has been improperly installed, modified or customized subject to accident, negligence, abuse or misuse.

To send a shock in for warranty please visit our website <http://www.iconvehicledynamics.com/tech-support/shock-service/>

## ICON VEHICLE DYNAMICS

PERFORMANCE SUSPENSION SYSTEMS AND SHOCK ABSORBERS

7929 Lincoln Ave. Riverside, CA 92504 Phone: 951.689.ICON Fax: 951.689.1016  
[www.iconvehicledynamics.com](http://www.iconvehicledynamics.com)



FOLLOW US ON FACEBOOK!



7929 Lincoln Ave. Riverside, CA 92504  
Phone: 951.689.ICON | Fax: 951.689.1016

PART #	DESCRIPTION
66518	23 FSD 4WD 4.5" FRONT 2.0 VS IR

COMPONENTS INCLUDED	
(1) 164919 23 FSD 4WD 4.5" FRONT 2.0 VS IR	(1) 611006 9/16" HD STEM BUSHING KIT
HARDWARE INCLUDED	
611006 HARDWARE KIT	
(2) HEAVY DUTY 9/16 ID STEM BUSHING (2) HEAVY DUTY STEM BUSHING RETAINER	(1) M12-1.25 NUT THIN (1) M12-1.25 JAM NUT
TOOLS REQUIRED	
JACK JACK STANDS TORQUE WRENCH	17MM SOCKET / WRENCH 18MM SOCKET / WRENCH 19MM SOCKET / WRENCH
TECH NOTES	
<p>1. YOUR ICON SHOCK ASSEMBLIES COME FACTORY CHARGED TO 180 PSI. RELEASING NITROGEN PRESSURE MAY LEAD TO SHOCK MALFUNCTION AND REDUCED RIDE QUALITY. FAILURE CAUSED BY LOW NITROGEN PRESSURE IS NOT COVERED UNDER ICON'S WARRANTY POLICY.</p> <p>2. ESTIMATED INSTALL TIME: 1-2 HOURS.</p>	



**WARNING!**

**\*\* READ ALL INSTRUCTIONS THOROUGHLY FROM START TO FINISH BEFORE BEGINNING INSTALLATION! IF THESE INSTRUCTIONS ARE NOT PROPERLY FOLLOWED SEVERE FRAME, SUSPENSION AND TIRE DAMAGE MAY RESULT TO THE VEHICLE!**

**\*\* ICON VEHICLE DYNAMICS RECOMMENDS THAT YOU EXERCISE EXTREME CAUTION WHEN WORKING UNDER A VEHICLE THAT IS SUPPORTED WITH JACK STANDS.**

**\*\* ICON VEHICLE DYNAMICS RECOMMENDS ALL INSTALLTION TO BE PERFORMED BY A PROFESSIONAL SHOP/SERVICE TECHNICIAN. PRODUCT FAILURE CAUSED BY IMPROPER INSTALLATION WILL NOT BE COVERED UNDER ICON'S WARRANTY POLICY.**

## INSTALLATION

- Using a properly rated jack, raise the front of the vehicle and support the frame rails with jack stands. Ensure the jack stands are secure and set properly before lowering the jack. NEVER WORK UNDER AN UNSUPPORTED VEHICLE. Remove the front wheels.
- Remove the factory shocks using a 17mm and 18mm socket/wrench.
- Install the shock stem bushing kit onto the factory shock mount as follows: 9/16" stem washer, stem bushing (locator lip up), factory shock mount, stem bushing (locator lip down), 12mm stem washer, 12mm nut. Fasten until bushing assembly is snug but do not overtighten. (19mm) Install the factory lower bolt. (18mm) [FIGURE 1]
- Reinstall wheels and lower vehicle back to the ground. [Torque lugs to factory spec]

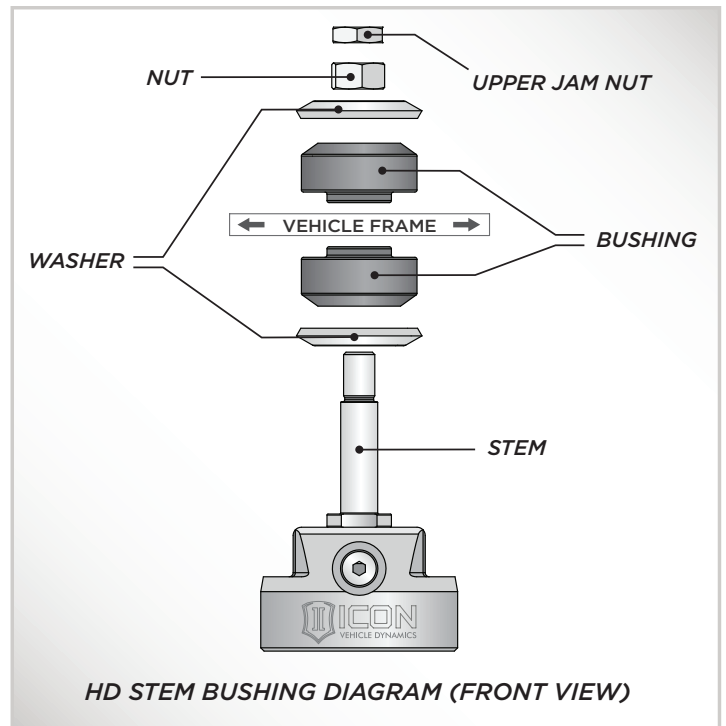

**VERIFY ALL FASTENERS ARE PROPERLY TORQUED BEFORE DRIVING VEHICLE.**

**RETORQUE ALL NUTS, BOLTS AND LUGS AFTER 100 MILES AND PERIODICALLY THEREAFTER.**

FIG.1

## 2.0 ALUMINUM SERIES TECHNICAL INFORMATION

### MAINTENANCE

ICON shock absorbers are a high quality rebuildable race style shock absorber designed for optimal performance. With a unit of this caliber on your vehicle, routine maintenance is required to keep them looking and operating in like new condition. Residual oil and assembly lube may be present at all seal paths from the factory out of the box and is considered normal. Pooling of oil however is not acceptable at any time and one should contact the ICON dealer where purchased.

**BELOW ARE GUIDELINES BASED ON HOW YOU USE YOUR VEHICLE BUT YOUR MILEAGE MAY VARY:**

#### **STREET USE:**

- Send in for factory servicing every 40,000 miles or if a leak develops, ride quality decreases, or they begin to make excessive noise.
- Remove any buildup of road salt, mud, or debris from shocks anytime accrued
- Clean with mild soap and water with each oil change or anytime you notice build up.
- Wax the cylinders yearly with automotive wax to prevent corrosion.
- Check nitrogen pressure yearly. (252004 charge needle assembly available at any ICON distributor)

#### **STREET/DIRT:**

- Send in for factory servicing every 15,000 miles or if a leak develops, ride quality decreases, or they begin to make excessive noise.
- Clean with mild soap and water with each oil change, offroad trip, or anytime you notice build up.
- Wax the cylinders yearly with automotive wax to prevent corrosion.
- Check nitrogen pressure each dirt outing. (252004 charge needle assembly available at any ICON distributor)

#### **DIRT USE:**

- Send in for factory servicing every 1,000 miles.
- Check nitrogen pressure each outing. (252004 charge needle assembly available at any ICON distributor)
- Remove any buildup of mud or debris from shocks after every outing.

#### **SELF-SERVICE:**

- Contact ICON for service kits & tools at (951) 689-4266.

### PRODUCT REGISTRATION

Please visit: <http://www.iconvehicledynamics.com/tech-support/registration/> to register your product.

### ICON VEHICLE DYNAMICS SHOCK ABSORBER WARRANTY

This shock absorber has a 1 year warranty against any manufacturer's defects. If a shock fails within the initial year of ownership, the shock must be shipped to ICON Vehicle Dynamics for inspection and service. If a shock is inspected and it has been determined the shock failed due to neglect, damage caused by improper installation or any other reason besides "normal wear and tear", the owner of said shock is responsible for all service costs. This includes labor, parts, and shipping.

ICON Vehicle Dynamics warrants to the original retail purchaser who owns the vehicle on which the product was originally installed. ICON Vehicle Dynamics does not warrant the product for finish, alterations, modifications and/or installation contrary to ICON Vehicle Dynamics instructions. ICON Vehicle Dynamics products are not designed, nor are they intended to be installed on vehicles used in race applications, for racing purposes or for similar activities. (A "race" is defined as any contest between two or more vehicles, or a contest of one or more vehicles against the clock, whether or not such contest is for a prize). This warranty does not include coverage for police or taxi vehicles, race vehicles, or vehicles used for government or commercial purposes. Also excluded from this warranty are sales outside of the United States of America and Canada.

ICON Vehicle Dynamics' obligation under this warranty is limited to the repair or replacement, at ICON Vehicle Dynamics' discretion, of the defective product. Any and all costs of removal, installation or re-installation, freight charges and incidental or consequential damages are expressly excluded from this warranty. Items that are subject to wear are not considered defective when worn and are not covered.

ICON Vehicle Dynamics components must be installed as a complete kit as shown in our current application guide. Any substitutions or exemptions of required components will immediately void the warranty. Some finish damage may happen to parts during shipping and is not covered under warranty.

This warranty is expressly in lieu of all other warranties expressed or implied. This warranty shall not apply to any product that has been improperly installed, modified or customized subject to accident, negligence, abuse or misuse.

To send a shock in for warranty please visit our website <http://www.iconvehicledynamics.com/tech-support/shock-service/>

## ICON VEHICLE DYNAMICS

PERFORMANCE SUSPENSION SYSTEMS AND SHOCK ABSORBERS

7929 Lincoln Ave. Riverside, CA 92504 Phone: 951.689.ICON Fax: 951.689.1016  
[www.iconvehicledynamics.com](http://www.iconvehicledynamics.com)



FOLLOW US ON FACEBOOK!

