



**PREMIUM FUEL REQUIRED – NOT E85 COMPATIBLE**

## **2011-2014 Ford F-150 6.2L PHASE 2 ROUSHcharger Kit**

P/N: 421432 (1162-P2CAL)

**EO # D-418-23**

### **Installation Instructions**



#### **Application:**

2011-2014 Ford F-150 with 6.2L 2-Valve Engine w/ Automatic Transmission.

#### **Important Notes:**

- Before installing your F-150 6.2L ROUSHcharger Kit, please read the installation manual and verify that all items are present. If you are missing hardware or have any questions, please contact ROUSH Performance at 1-800- 59-ROUSH.
- Premium fuel (91 octane or higher) is required to prevent “spark-knock” or detonation under certain operating conditions.**
- Once this modification has been completed this vehicle is no longer capable of running E85 (It is no longer a flex-fuel vehicle).**
- Operating your engine without the Roush PCM recalibration will result in engine damage or failure and will void your warranty.
- The use of fuel additives (ie. octane boosters) is not recommended. There is a possibility that these chemicals can damage your engine and cause drivability issues with your vehicle.
- Installation of this kit voids the 3 yr / 36,000 mile limited ROUSH Powertrain Warranty.**



**PREMIUM FUEL REQUIRED – NOT E85 COMPATIBLE**

**TABLE OF CONTENTS**

PACKAGING LIST FOR ITEM 421432..... 3  
(1162-P2CAL) SUPERCHARGER KIT ..... 3  
EQUIPMENT AND SUPPLIES REQUIRED ..... 7  
GLOSSARY OF TERMS ..... 8  
INFORMATION ABOUT THE SUPERCHARGER BYPASS OPERATION ..... 8  
LIMIT OF LIABILITY STATEMENT ..... 9  
SAFETY PRECAUTIONS ..... 9  
SECTION A – DISASSEMBLY ..... 10  
SECTION B – MODIFICATIONS..... 23  
    Airbox Modification ..... 23  
    Brake Booster Hose Modification..... 24  
    VMV Hose Modification ..... 26  
    TPS/ETC Wiring ..... 29  
    Canister Purge Valve Wiring..... 31  
    Intercooler Pump Wiring..... 33  
    Air Charge Temperature (ACT) Wiring ..... 37  
    Knock Sensor Orientation Adjustment ..... 39  
    Alternator B+ Post Modification..... 40  
SECTION C – SUBASSEMBLY ..... 41  
    Intercooler Low Temperature Radiator (LTR)..... 41  
    Intake Manifold Build Up ..... 44  
    Throttle Body Spacer Assembly..... 45  
    Fuel Rail Assembly..... 48  
SECTION D – INSTALLATION ..... 49  
    Intercooler Reservoir Mounting ..... 49  
    Intercooler Radiator Assembly Mounting..... 53  
    Intercooler Hose Routing..... 58  
    FEAD Bracket Installation ..... 63  
    Fuel Charging and Supercharger Installation ..... 65  
    Air Induction System ..... 88  
    Final Assembly..... 93  
    PCM Flashing..... 96



**PREMIUM FUEL REQUIRED – NOT E85 COMPATIBLE**

**PACKAGING LIST FOR ITEM 421432**  
**(1162-P2CAL) SUPERCHARGER KIT**

Part Ref	Description	Part Number	Qty
	<b>Air Induction</b>	---	
1	Upper Airbox Lid Assembly	1111-9A600	1
2	MAF Tube	11SC-12B579	1
3	MAF Tube to Airbox Lid Seal	1111-9645	1
4	Air Filter	997- 466	1
5	Clean Air Tube	11SC-9B659	1

Part Ref	Description	Part Number	Qty
	<b>Hardware Kit A – Induction</b>	<b>11SC-TVSHKA</b>	<b>1</b>
6	Bolt - M8 x 1.25 x 25	W500224	2
7	J-Clip M8	W520823	2
8	Vacuum Fitting – Brake Booster Reference (3/8 x 3/8)	P2233A	1
9	Vacuum Fitting – S/C Bypass Reference (1/4 x 1/4)	P217N	1

Part Ref	Description	Part Number	Qty
10	Fuel Charging Assembly	1162-9H487	1
11	Supercharger Assembly	1162-6F066	1
12	Fuel Rail	1162-9F792	1
13	Fuel Injector Kit	M-9593-LU47ROU	1
14	Throttle Body Assembly – Dual 60 mm	R07060150	1
15	Throttle Body Spacer Assembly	1162-9A589	1
16	Bracket – Coil On Plug Support	1162-12A359	2

Part Ref	Description	Part Number	Qty
	<b>Hardware Kit B – Fuel Charging</b>	<b>1162-TVSHKB</b>	<b>1</b>
17	Gasket – Throttle Body To Spacer	R07060153	1
18	Gasket – Throttle Body Spacer to Supercharger	R07060152	1
19	Bolt – T/B to Spacer & Supercharger & Frt Intake Mntg (M6 x 32.5)	R18020009	10
20	Bolt – Intake to Cylinder Heads (M6 x 74.5)	R18020053	10
21	Bolt – Supercharger to Intake (M8 x 40)	W500112	10

Part Ref	Description	Part Number	Qty
	<b>FEAD</b>	---	
22	FEAD Bracket	1162-8B653	1
23	ROUSH 6K FEAD Belt	6K3200-8620	1
24	Pulley - Idler B/S 76mm Flanged	R07020049	2
25	Supercharger Pulley – Ø 75 mm	1162-6K75	1



**PREMIUM FUEL REQUIRED – NOT E85 COMPATIBLE**

Part Ref	Description	Part Number	Qty
	<b>Hardware Kit C – FEAD</b>	<b>1162-TVSHKC</b>	<b>1</b>
26	Dowel (Ø 11mm)	R07050097	2
27	Pulley - Idler B/S 76mm Flanged	R07020049	1
28	Bolt – Idler (M8 x 28 large washer)	R18020060	1
29	Bolt – FEAD Bracket to Engine (M8 x 84)	R18020054	1
30	Bolt – FEAD Bracket to Engine (M8 x 50)	W500313	1
31	Bolt – FEAD Bracket to Engine (M8 x 44)	W705430	2
32	Bolt – Alternator Mounting (M10 x 75)	W500127	3
33	Bolt – Supercharger Pulley (M6 x 14)	N605771	6
34	Tube Assembly – Heater Water Outlet	1162-18674	1

Part Ref	Description	Part Number	Qty
	<b>PCV &amp; Vacuum</b>	<b>---</b>	
35	PCV Bubbler Hose w/Clamps	R07060175	1
36	Evaporative Emission Canister Purge Valve Line	27004	1
37	Clamp – Worm Drive (VMV Line & Brake Booster)	62003	4
38	7/32" Vacuum Hose – Supercharger Bypass (4")	R18140001	1
39	7/32" Vacuum Harness – Supercharger Bypass Reference (23")	R18140001	1
40	½" x 3/8" Adapter Fitting – Brake Booster Hose	5463K225	1

Part Ref	Description	Part Number	Qty
	<b>Decals / Labels &amp; Instructions</b>	<b>---</b>	
41	Decal – 2011 Belt Routing Diagram	1162-6E072	1
42	Supercharger Badge "ROUSH"	R09010347	1
43	Decal – Premium Fuel Only – No E85	R07110004	1
44	Decal – Premium Unleaded Fuel Only	13109A095	1
45	Decal - PCM	R07100008	1
46	Decal – EO Label	D41823-9A095EO	1
47	Warranty Registration Card	1150-TVSCALWC	1
48	F-150 Customer Care Pack – Optional Warranty Information	1150-CCP	1
49	Website - Installation Manual One Pager	1315-P1INST	1

Part Ref	Description	Part Number	Qty
	<b>Intercooler System</b>	<b>---</b>	
50	Degas Bottle	R07070007	1
51	Intercooler Electric Water Pump with Bracket	392022009	1
52	Bracket - LTR Upper Cross Brace	1111-8K241	1
53	Intercooler Low Temp Radiator (LTR)	13108K229	1
54	3/4" Hose – Degas Bottle Inlet	1111-8D031	1
55	3/4" Hose – Intercooler Pump Inlet	1111-8D029	1
56	3/4" Hose – Intercooler Pump to LTR	1113-FFLTR8K236	1
57	3/4" Hose – Intercooler LTR Outlet	1111-8K236	1
58	3/4" Hose – Intercooler LTR Outlet	1111-8D030	1



**PREMIUM FUEL REQUIRED – NOT E85 COMPATIBLE**

Part Ref	Description	Part Number	Qty
	<b>Hardware Kit D – Intercooler System</b>	<b>11SC-TVSHKD</b>	<b>1</b>
59	Bracket – LTR Upper LH	1111-8K242	1
60	Bracket – LTR Upper RH	1111-8K243	1
61	Bracket – LTR Lower RH	1111-8K245	1
62	Bracket - Intercooler Pump Mounting	1111-8C419	1
63	Clamps – 3/4" Hoses (Constant Tension)	CT19x12-BO	10
64	Bolt M8 x 1.25 x 30 - LTR Mounting Brackets	N808920	8
65	Nut – I/C Pump Mounting Bracket (M8)	W520413	2
66	Nut - M6 x 1.0 - I/C Relay Mounting & Radio Capacitor Relocation	W520412	3
67	Bolt – M6 x 1.0 x 20 I/C Relay Mounting	W500214	1
68	Bolt – M8 x 1.25 x 27 (Self Tapping) I/C Cross Brace Mounting	N802455	2
69	3/4" x 3/4" Hose Adapter	28605	1
70	Zip Tie – 6"	16N865	2
71	3/4" Split Loom Hose Convolute – 3" Length	1312-TRANSCONV	1
72	NVH Isolator – I/C Pump to LTR	13108Y419	1

Part Ref	Description	Part Number	Qty
	<b>Wiring</b>	---	
73	Electrical Jumper – Intercooler Pump	13118W501	1
74	ACT Wiring Harness	131112A690	1
75	TPS Extension Harness	131114A595	1
76	Canister Purge Valve (VMV) Extension Harness	13119G866	1

Part Ref	Description	Part Number	Qty
	<b>Hardware Kit E – Degas Bottle Mounting</b>	<b>1162-TVSHKE</b>	<b>1</b>
77	Degas Bottle Cap	9C3Z-8101-B	1
78	Nut – Degas Strut Mounting Bracket Upper to Lower (M8 x 1.25)	W520413	2
79	Bolt - M6 x 1.0 x 8 - Degas Bottle to Strut Bracket	R18020010	1
80	Nut - M6 x 1.0 - Degas Bottle to Fender Bracket	W520412	2
81	Mounting Bracket - Degas Bottle to Strut Mount Upper	1111-6B634U	1
82	Mounting Bracket - Degas Bottle to Strut Mount Lower	1162-6B634L	1
83	Mounting Bracket - Degas Bottle to Inner Fender	1111-6B633-AA	1

Part Ref	Description	Part Number	Qty
	<b>Hardware Kit F – Full Face LTR Mounting</b>	<b>11SC-TVSHKF</b>	<b>1</b>
84	Screw, M8 x 1.25 x 27 Self Tapping	N802455	1
85	Bolt, M8 x 1.25 x 29	W500224	4
86	Grommet	R07060107	4
87	Steel Grommet Insert	R07060108	4
88	Bracket – Full Face LTR Upper LH	1113-FFLTR8K242	1
89	Bracket – Full Face LTR Upper RH	1113-FFLTR8K243	1
90	Bracket – Full Face LTR Lower LH	1113-FFLTR8K244	1
91	Bracket – Full Face LTR Lower RH	1113-FFLTR8K245	1



**PREMIUM FUEL REQUIRED – NOT E85 COMPATIBLE**

Part Ref	Description	Part Number	Qty
	<b>CALKIT</b>	<b>1162-P2CALKIT</b>	<b>1</b>
92	Optional Roush PCM Flash	PCM-FLASHDOC	1
93	Flash Voucher Card	P1162-P2	1

Part Ref	Description	Part Number	Qty
	<b>Raptor FEAD SHIELD</b>	<b>1162-SHLDHWK</b>	<b>1</b>
94	Standoff Aluminum Spacer .375 IN ID x 75IN OD x 2.48 L	1162-3N856	4
95	Power Steering FEAD Plate E-Coated	1162-3R756	1
96	Bolt M8X110	BM8X125X110HNF	4
97	Washer, Flat M8 x 20 X 2.0 MM Zinc Plated	WM8X20X2	4

**If you are missing any items, please call us toll free at 1-800-59-ROUSH.**



**PREMIUM FUEL REQUIRED – NOT E85 COMPATIBLE**

**EQUIPMENT AND SUPPLIES REQUIRED**

- 1/4" and 3/8" Drive Ratchets with Extensions
- Metric and Standard Socket Sets (short and deep recommended)
- 1/2" Drive Ratchet or Breaker Bar
- Metric and Standard Wrench Sets
- 3/8" Drive Torque Wrench (7-35 ft-lb range)
- Short Phillips-head Screwdriver
- 5/8" Fuel Line Removal Tool
- T-20 Torx Bit Screwdriver or Socket
- 5/16" Drill Bits and Drill motor
- Coolant (meeting Factory Ford specification for 2011+ F-150)
- 6" Scale, Tape Measure, or Other Measuring Device
- Assembly Lubricant (White Lithium Grease or Petroleum Jelly)
- Medium Strength Liquid Threadlocker (Blue Loctite 242 or equivalent)
- Electrical Tape
- Sharp Knife or Razor Blade
- Solder & Soldering Iron
- Heat Gun or Small Torch for Heat Shrink Tubing
- Tie Straps (Zip Ties)
- Trim Pad Tool (for pushpin removal)
- Fender Cover (2)
- M10 x 1.5 Die (to chase threads on bolts)



**PREMIUM FUEL REQUIRED – NOT E85 COMPATIBLE**

## **GLOSSARY OF TERMS**

ACT	Air Charge Temperature Sensor (From the factory, this function is integrated into the MAF sensor. With this kit, a separate ACT sensor is installed into the intake manifold)
ETC	Electronic Throttle Control
MAFS	Mass Air Flow Sensor
PCM	Powertrain Control Module (a.k.a. ECM, ECU, PCU, EEC)
PCV	Positive Crankcase Ventilation
TPS	Throttle Position Sensor
RDT	ROUSH Diagnostic Tool
VMV	Vapor Management Valve (aka Canister Purge Valve)
Breakout Point	A place in an electrical harness where the wiring for an individual component leaves (breaks out of) the main harness to attach to an individual component.

## **INFORMATION ABOUT THE SUPERCHARGER BYPASS OPERATION**

There is a great deal of misinformation about the function of supercharger bypass systems. The supercharger is a positive-displacement pump; that is, so long as it is rotating, it is always pumping air. During low demand or high vacuum operation (i.e. idle, deceleration, and light throttle cruise), the pumping action is undesirable as it creates unwanted heat and noise. The bypass circuit, when open, prevents any pressure buildup across the supercharger and allows air to circulate through the rotors, allowing the supercharger to “idle” freely during these conditions. This results in reduced noise, and by reducing heat buildup in the intake, significantly improves street and strip performance. As throttle demand increases, the bypass circuit is closed, resulting in full performance from the supercharger. The bypass circuit is never used to limit or control boost during full-throttle operation and defeating or altering the bypass function will not result in improved performance in any condition, and will result in poor drivability.





**PREMIUM FUEL REQUIRED – NOT E85 COMPATIBLE**

## **LIMIT OF LIABILITY STATEMENT**

The information contained in this publication was accurate and in effect at the time the publication was approved for printing and is subject to change without notice or liability. ROUSH Performance Parts reserves the right to revise the information presented herein or to discontinue the production of parts described at any time.

## **SAFETY PRECAUTIONS**

**STOP! CAREFULLY READ THE IMPORTANT SAFETY PRECAUTIONS AND WARNINGS BEFORE PROCEEDING WITH THE INSTALLATION!**

Appropriate disassembly, assembly methods and procedures are essential to ensure the personal safety of the individual performing the kit installation. Improper installation due to the failure to correctly follow these instructions could cause personal injury or death. Read each step of the installation manual carefully before starting the installation.

- ! Always wear safety glasses for eye protection.
- ! Place the ignition switch in the OFF position.
- ! Always apply the parking brake when working on the vehicle.
- ! Block the front and rear tire surfaces to prevent unexpected vehicle movement.
- ! Operate the engine only in well-ventilated areas to avoid exposure to carbon monoxide.
- ! Do not smoke or use flammable items near or around the fuel system.
- ! Use chemicals and cleaners only in well-ventilated areas.
- ! Batteries can produce explosive hydrogen gas which can cause personal injury. Do not allow flames, sparks or flammable sources to come near the battery.
- ! Keep hands and any other objects away from the radiator fan blades.
- ! Keep yourself and your clothing away from moving parts when the engine is running.
- ! Do not wear loose clothing or jewelry that can be caught in rotating or moving parts.



**PREMIUM FUEL REQUIRED – NOT E85 COMPATIBLE**

## **SECTION A – DISASSEMBLY**

The following section will guide you through the disassembly of the stock components. Special care should be taken to label fasteners and parts that are taken off during this procedure since many will be reused:

1. Cover both fenders with fender covers to protect the vehicle finish.
2. Release the fuel system pressure (**NOTE:** The following procedure is taken directly from the Ford Service Manual).

 **WARNING:** Fuel in the fuel system remains under high pressure even when the engine is not running. Before working on or disconnecting any of the fuel lines or fuel system components, the fuel system pressure must be relieved. Failure to do so can result in personal injury.

 **WARNING:** Do not smoke or carry lighted tobacco or open flame of any type when working on or near any fuel-related components. Highly flammable mixtures are always present and can be ignited, resulting in personal injury.

- a. Disconnect the Fuel Pump Control Module electrical connector. It is located on the frame rail above the spare tire.

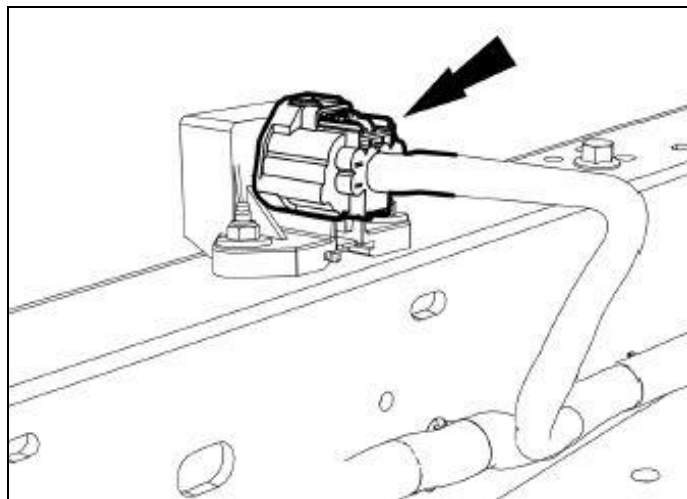

- b. Start the engine and allow it to idle until it stalls.
- c. After the engine stalls, crank the engine for approximately 5 seconds to make sure the fuel rail pressure has been released.
- d. Turn the ignition switch to the OFF position.



## PREMIUM FUEL REQUIRED – NOT E85 COMPATIBLE

- Using an 8mm wrench, disconnect the (-) negative & (+) positive connections to the battery and remove the battery from the vehicle.



**Before continuing, refer to the CALKIT included with your ROUSHcharger kit. Determine the PCM flash method you will be using. If performing the PCM flash yourself or at a preferred ROUSH dealer, proceed to step 6. If sending the PCM to ROUSH for a ROUSH performed PCM flash, continue with steps 4 and 5.**

- Remove the PCM cover by undoing the two crimp nuts retaining the cover to the studs.
- Undo the three (3) PCM (Powertrain Control Module) connectors by lifting the grey levers over the connector back shell and lifting the connectors from their sockets. Remove the PCM by removing the two studs and pulling the PCM forward and lifting out of the engine compartment. Follow the instructions on the next page as soon as possible to help minimize the amount of time you are without a PCM.

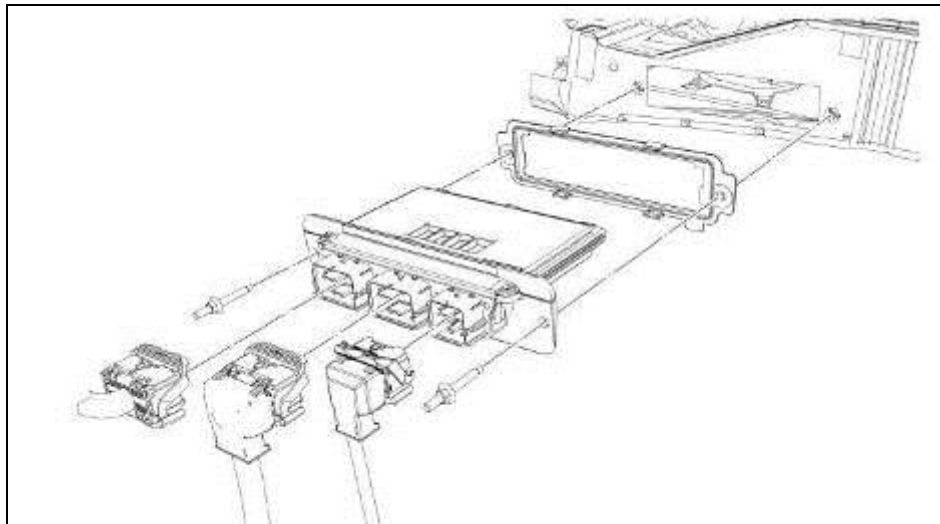

**Important: Be sure to write your VIN number and phone number on the PCM using a permanent marker.**

**Please do this in the case that we need to contact you for additional vehicle information.**



## **PREMIUM FUEL REQUIRED – NOT E85 COMPATIBLE**

### **INSTRUCTIONS FOR RETURNING THE PCM TO ROUSH FOR CALIBRATION**

Outlined below are the instructions for returning your stock powertrain control module (PCM) to Roush Performance Products so we can install our calibration to make the engine run properly with the new components. **Please complete the “Base Limited Warranty Registration” card and include it, along with the PCM, the “Optional Roush PCM Flash” request document, and the “Voucher Card”.** Once we receive your PCM, we will reprogram and return it back to you the same day for next-day delivery. **Operating your engine without our calibration will result in engine damage or failure and will void all warranty.**

**Note: It is important to reinstall the PCM in the vehicle it came from to prevent setting a trouble code and having to relearn the anti-theft code which can only be performed using specialized Ford Service Bay tools.**

- If you haven't already done so, write your vehicle identification number (VIN) and phone number on the PCM using a permanent marker.
- Using bubble wrap, or another appropriate packing material, wrap and package the PCM to help prevent it from being damaged during shipping.
- Place the wrapped PCM in an appropriate shipping box.
- **Complete the “Warranty Registration Card” (1150-TVSCALWC),**
- **Complete the “Optional ROUSH PCM Flash” request document (PCM-FLASHDOC) and attach the flash Voucher Card (P1162-P2) to the document.**
- **Include the “Warranty Registration Card”, “Optional ROUSH PCM Flash” document, and the Voucher Card in the shipping box, along with the PCM.**
- Ship the PCM and contents to:

**ATTN: PCM FLASH  
39555 Schoolcraft Rd  
Plymouth, MI 48170**

Upon receipt of the PCM, a customer service representative will contact you to arrange payment. Once you receive your ROUSH flashed PCM, reverse steps 4 and 5 for PCM installation.



## PREMIUM FUEL REQUIRED – NOT E85 COMPATIBLE

6. With the engine cool, remove the cap on the engine coolant degas reservoir bottle and the upper radiator fill cap. Drain the coolant using the petcock located on the lower passenger side of the radiator. Re-tighten the petcock once the engine coolant has been drained.

TIP: Connect a 3/8" hose to the drain fitting next to the petcock and run into a clean drain pan or bottle. Use a 3/4" wrench to open petcock and allow coolant to drain out of the fitting.

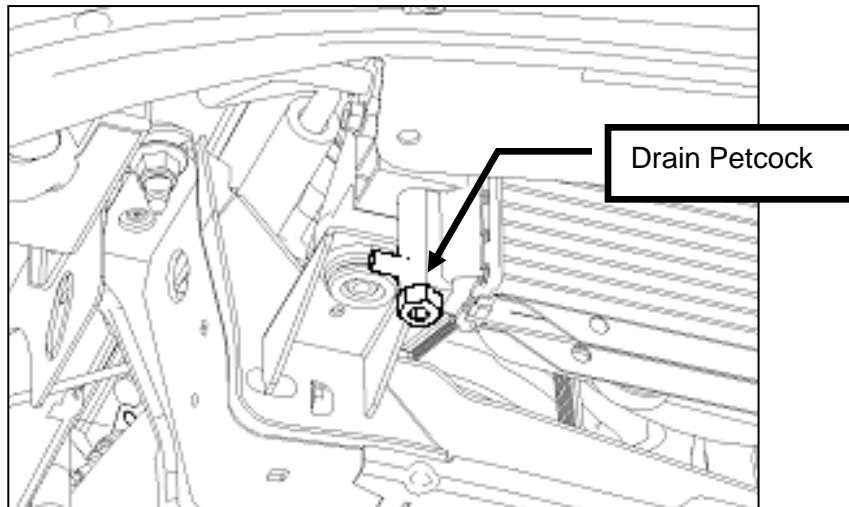

7. Loosen the two clamps at either end of the clean air tube (items 1 & 3) and remove the clean air tube (item 2) from the vehicle. These components will not be reused.

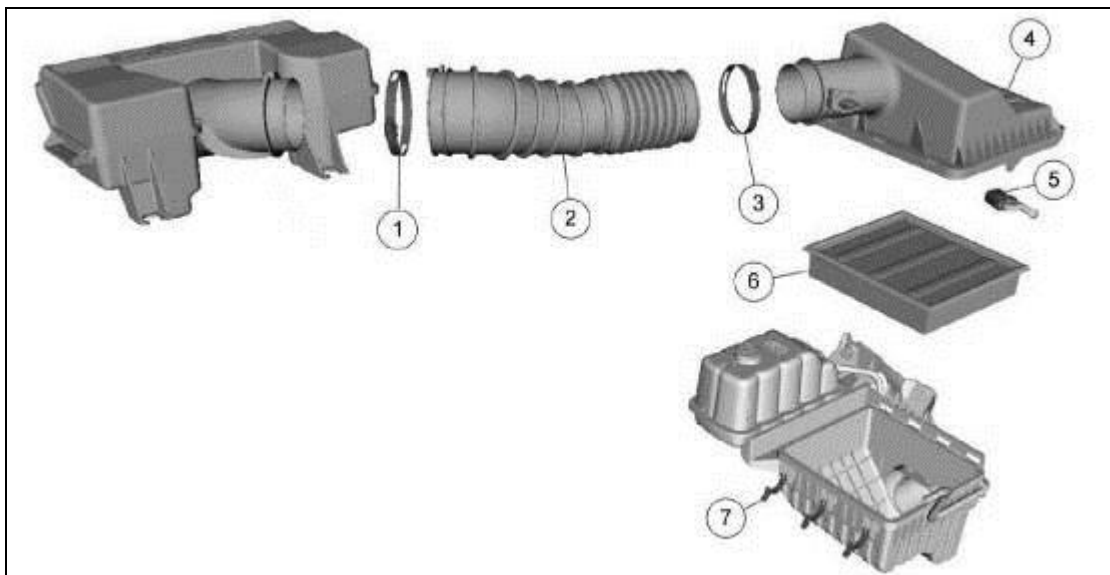

8. Disconnect the MAF (Mass Air Flow) sensor electrical connector (item 5) by pulling the red locking tab back and pressing the black release tab. Release the three locking tabs (item 7) securing the upper airbox lid to the lower airbox. Remove the upper airbox lid (item 4) and air filter (item 6) from the vehicle. The airbox lid and filter will not be re-used.



## PREMIUM FUEL REQUIRED – NOT E85 COMPATIBLE

9. Disconnect the PCV line (item 8) at both ends and remove from the vehicle and set aside as this will be re-used. Disconnect the brake booster vacuum line (item 9) from the resonator chamber. Remove the two bolts (item 10) securing the resonator chamber to the alternator mounting bracket. Loosen the clamp (item 11) on the back side of the resonator chamber. Remove the push pin clamp (item 12) that retains the heater hoses to the resonator chamber. Pull forward firmly on the resonator chamber (item 13) and remove it from the vehicle. This will not be re-used.

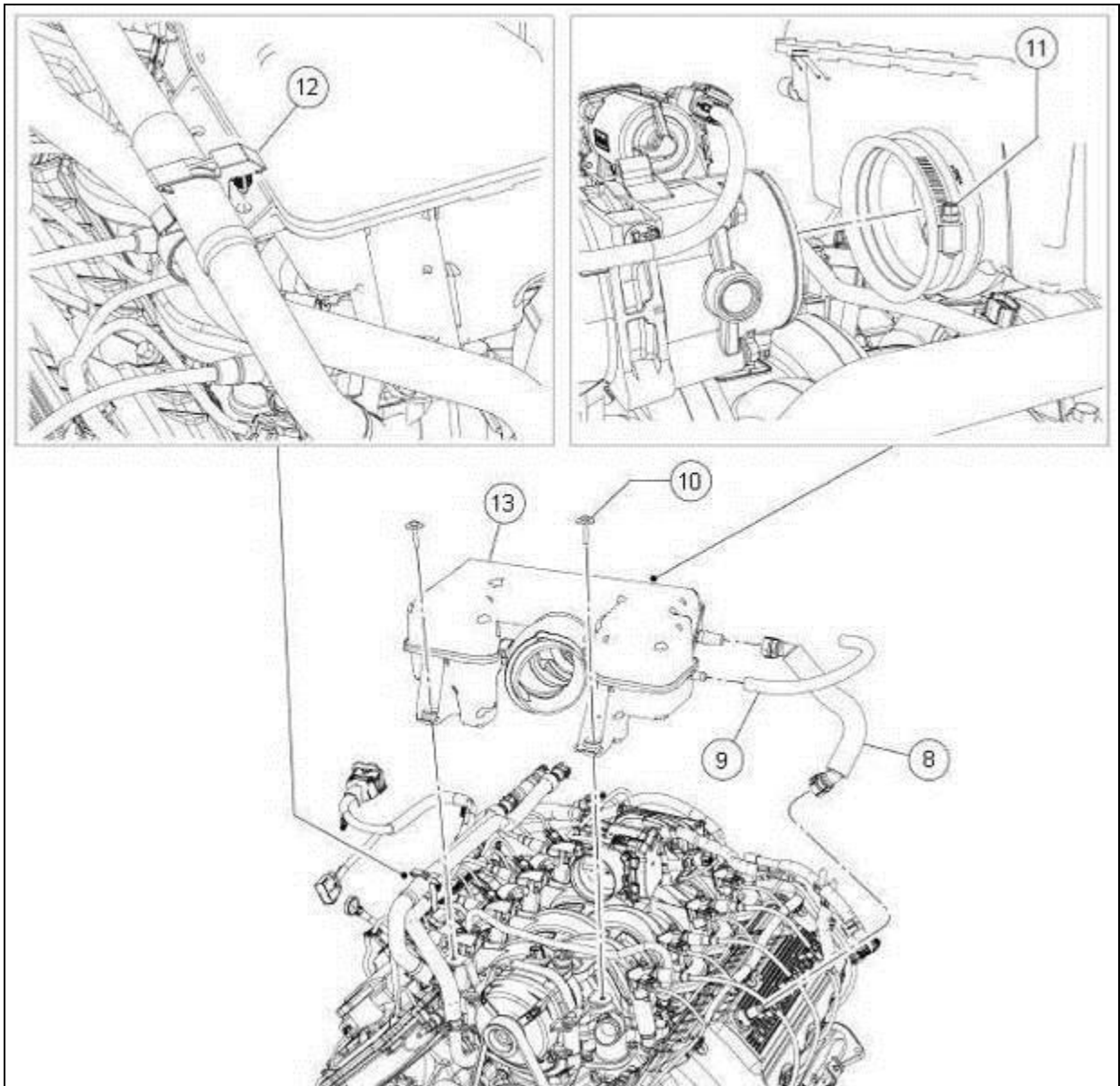

10. Remove the Front Engine Accessory Drive (FEAD) belt from the vehicle. Rotate the FEAD Tensioner clockwise to release the belt tension and remove the belt.



**PREMIUM FUEL REQUIRED – NOT E85 COMPATIBLE**

11. Undo the three (3) bolts securing the alternator and remove the stamped bracket from the vehicle. Disconnect the B + cable and the alternator electrical connector. Remove the alternator and set it aside.

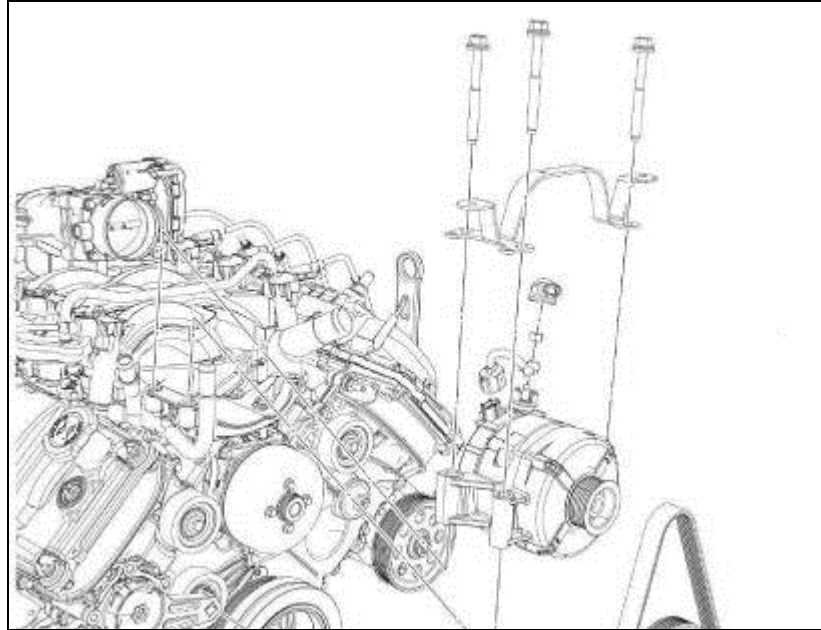

12. Undo the clamp on the heater return hose and disconnect the hose from the tube going into the engine block. Position this hose aside.

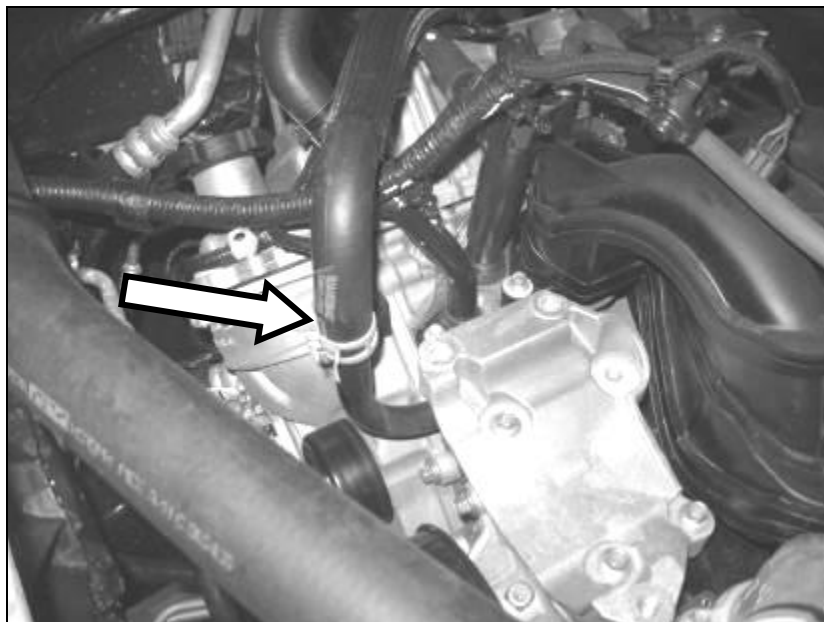



**PREMIUM FUEL REQUIRED – NOT E85 COMPATIBLE**

13. Remove the two bolts securing the thermostat housing inlet and undo the upper radiator hose at the radiator. Place the bolts aside as they will be re-used.

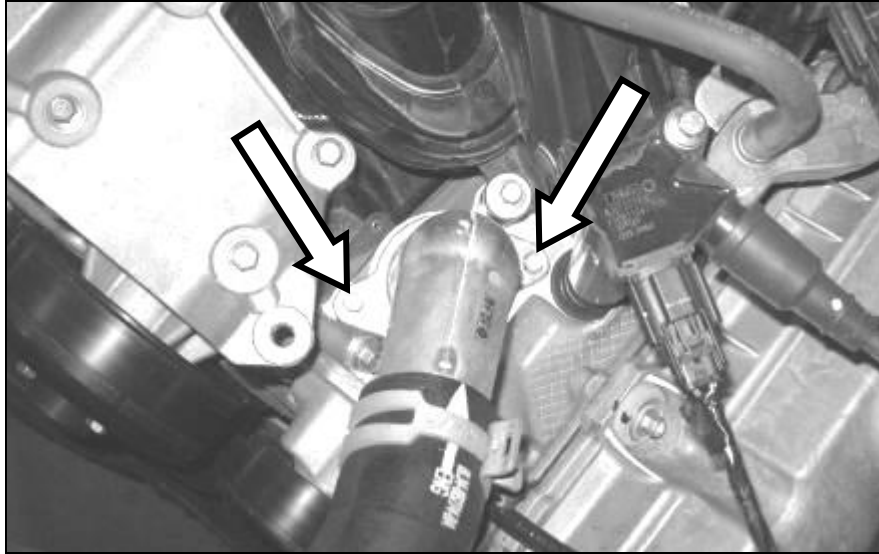

14. Undo the clip that retains the upper radiator hose to the fan shroud and remove the hose and thermostat inlet from the vehicle.

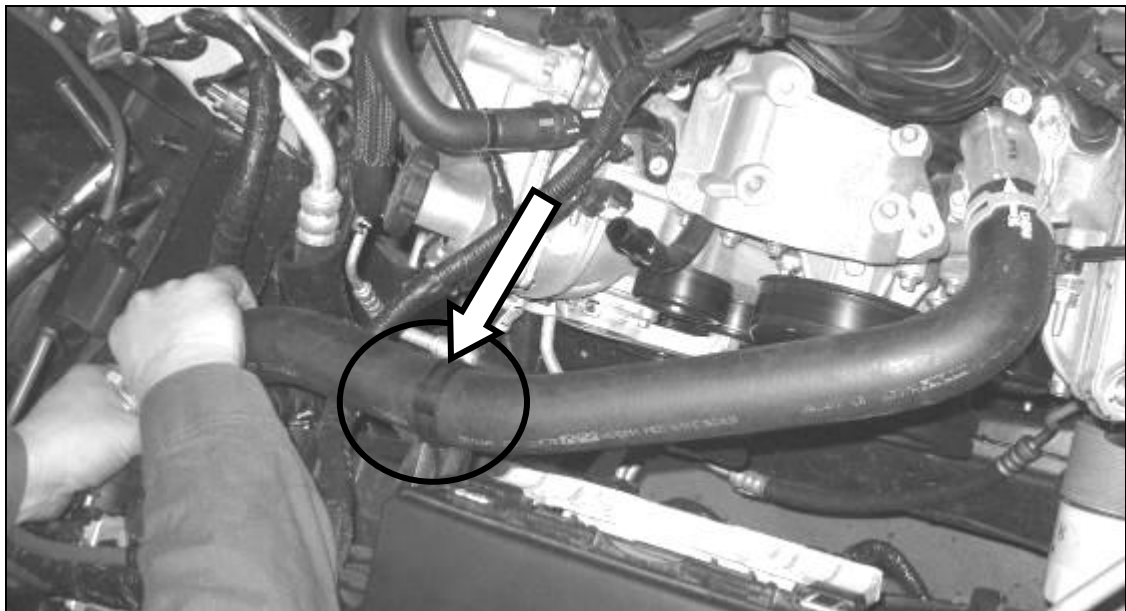





**PREMIUM FUEL REQUIRED – NOT E85 COMPATIBLE**

15. Remove the four bolts retaining the alternator mounting bracket and remove the bracket from the vehicle. These parts will not be re-used.

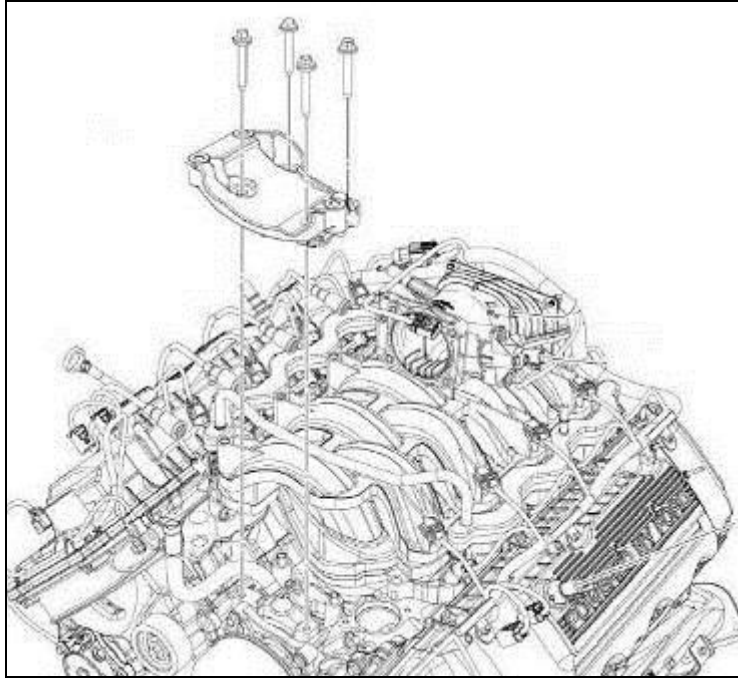

16. Remove the heater return tube that is connected to the engine block. Set the fastener aside as it will be re-used. The tube will be discarded.

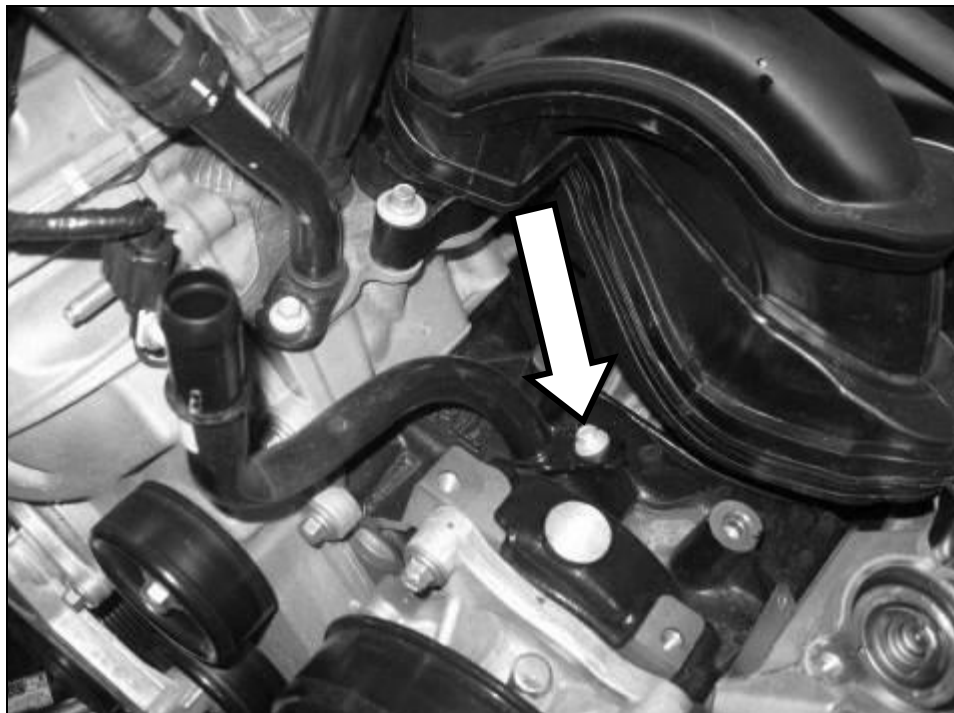



**PREMIUM FUEL REQUIRED – NOT E85 COMPATIBLE**

17. Disconnect the throttle body electrical connector. (Pull the red locking tab back; press the black release tab to disengage the lock). Undo the push pin retaining the harness to the intake manifold.

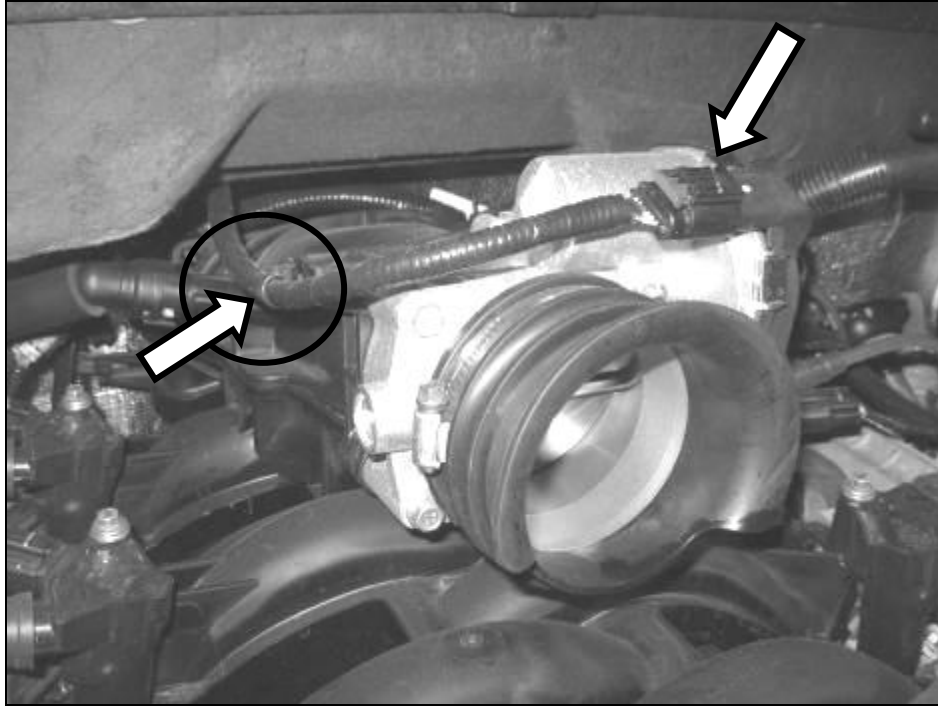

18. Disconnect the VMV electrical connector and undo the push pin retaining the harness to the intake manifold. Disconnect the brake aspirator hose from the intake manifold.

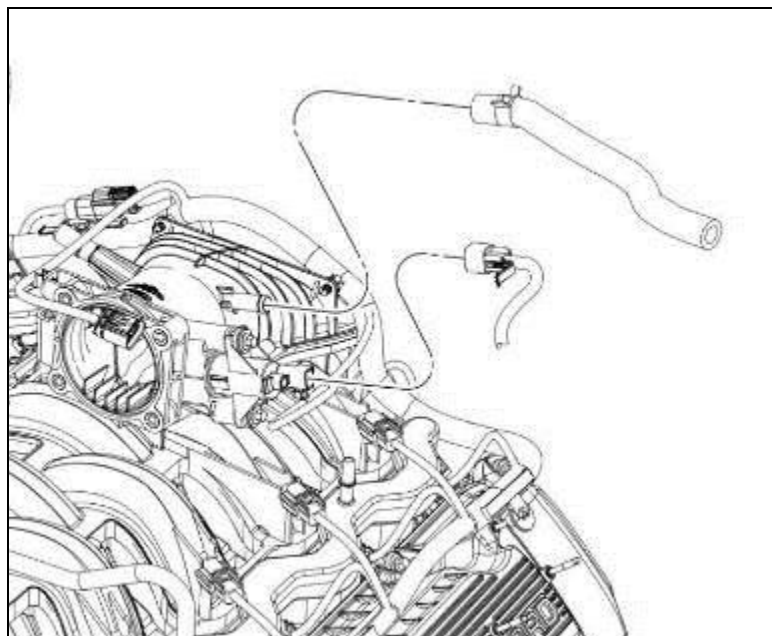



**PREMIUM FUEL REQUIRED – NOT E85 COMPATIBLE**

19. Disconnect the VMV (evaporative emission canister purge valve) tube quick connect fitting. Disconnect the Fuel Supply line jumper to the fuel rail.

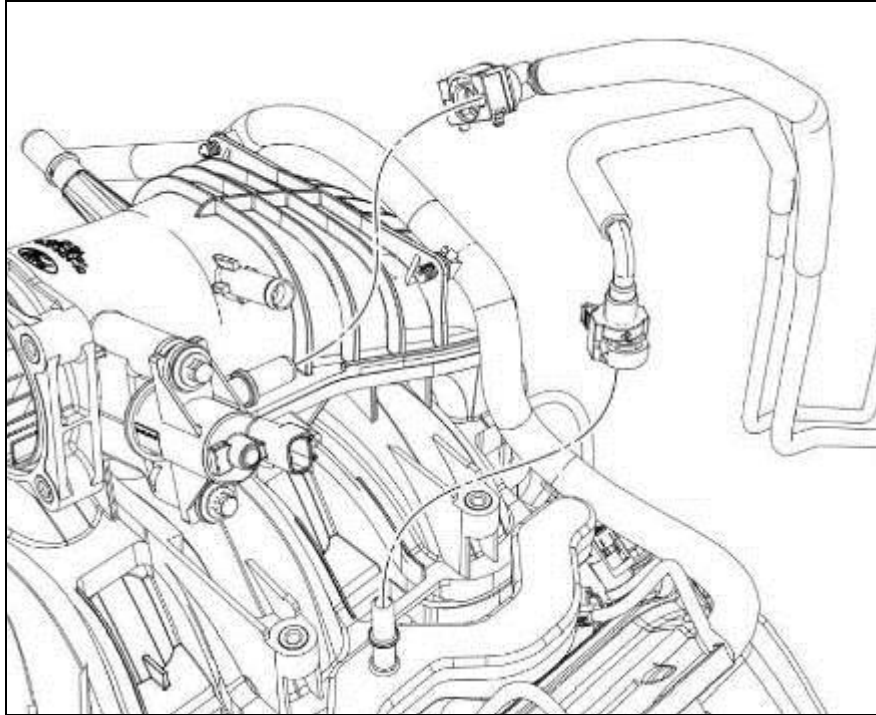

20. Remove the PCV Purge line from the intake manifold and right-hand cam cover. Set this line aside as it will be re-used.

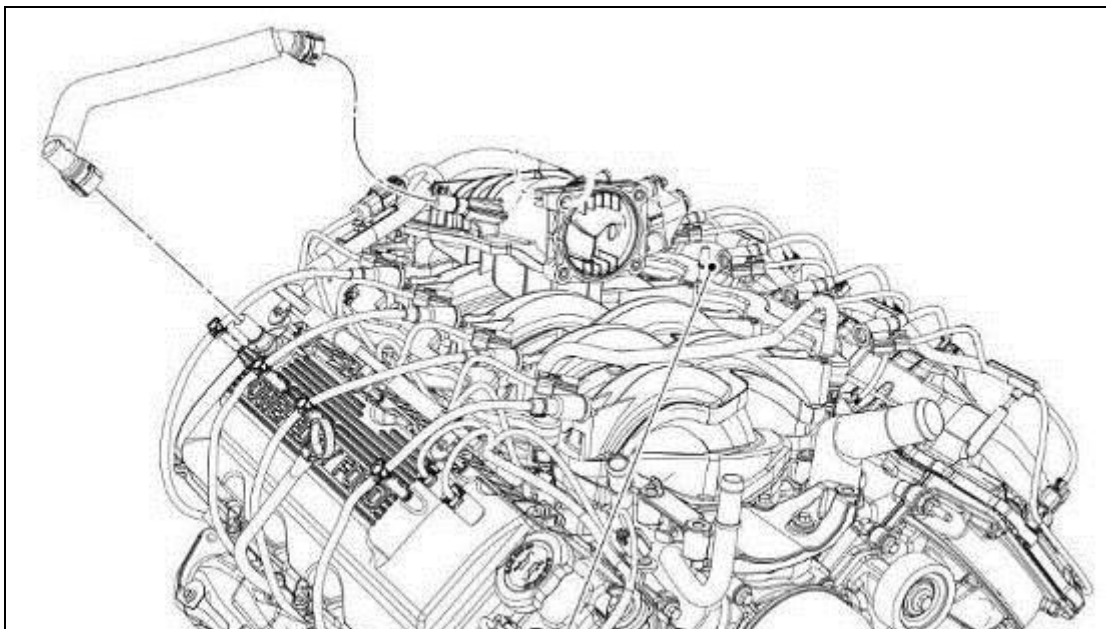



**PREMIUM FUEL REQUIRED – NOT E85 COMPATIBLE**

21. Carefully detach the four (4) wiring harness retainers from the rear of the intake manifold. These will not be reused once the new manifold is installed to retain the harness.

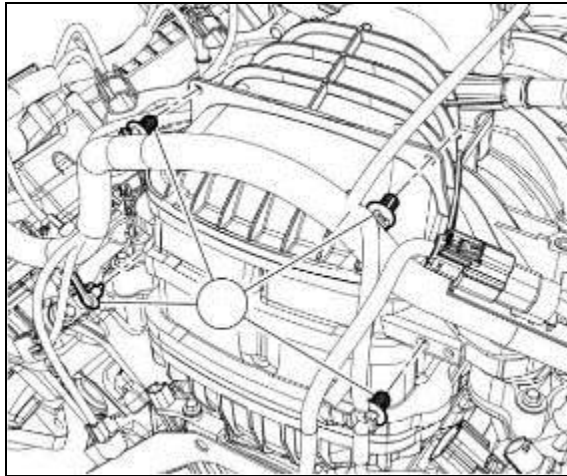

22. Disconnect the eight (8) coil pack electrical connectors and coil lead wires. Remove the eight (8) coil pack mounting bolts and remove the coil packs from the vehicle. Set the coil packs and the mounting fasteners aside as they will be re-used.

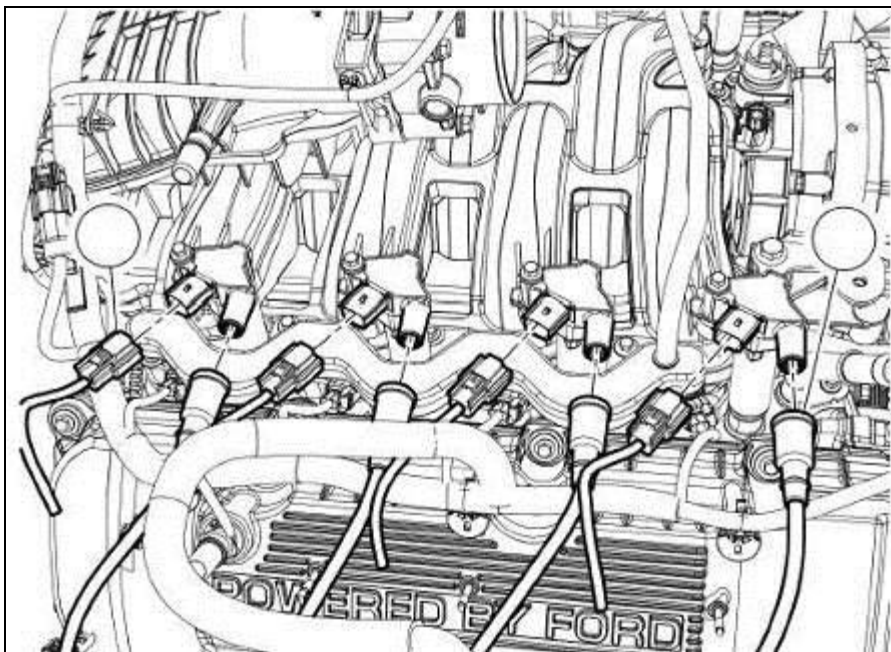



**PREMIUM FUEL REQUIRED – NOT E85 COMPATIBLE**

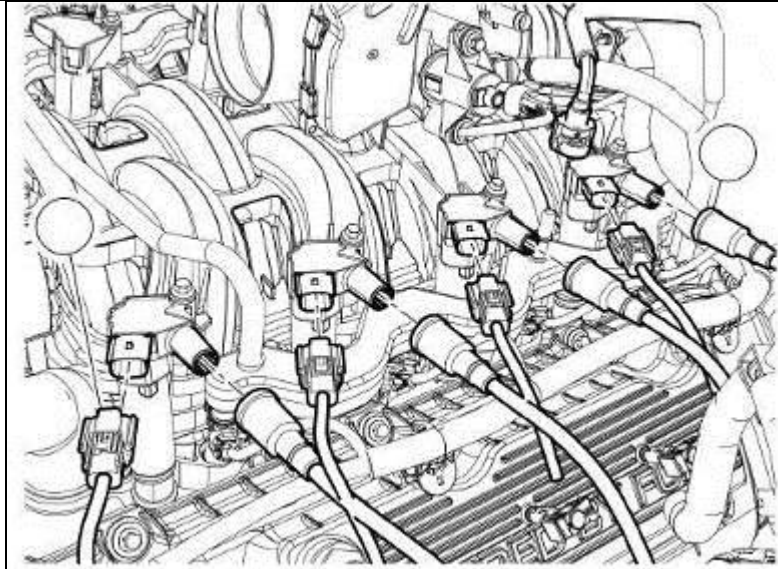

23. Disconnect the eight (8) fuel injector electrical connectors.
24. Remove the four (4) fuel rail bolts. **These bolts will be reused.** **NOTE:** It is not necessary to remove the fuel rail from the intake manifold assembly.
25. Remove the remaining twelve (12) intake manifold mounting bolts and remove the intake manifold and fuel rail assembly from the vehicle. This hardware will not be reused.

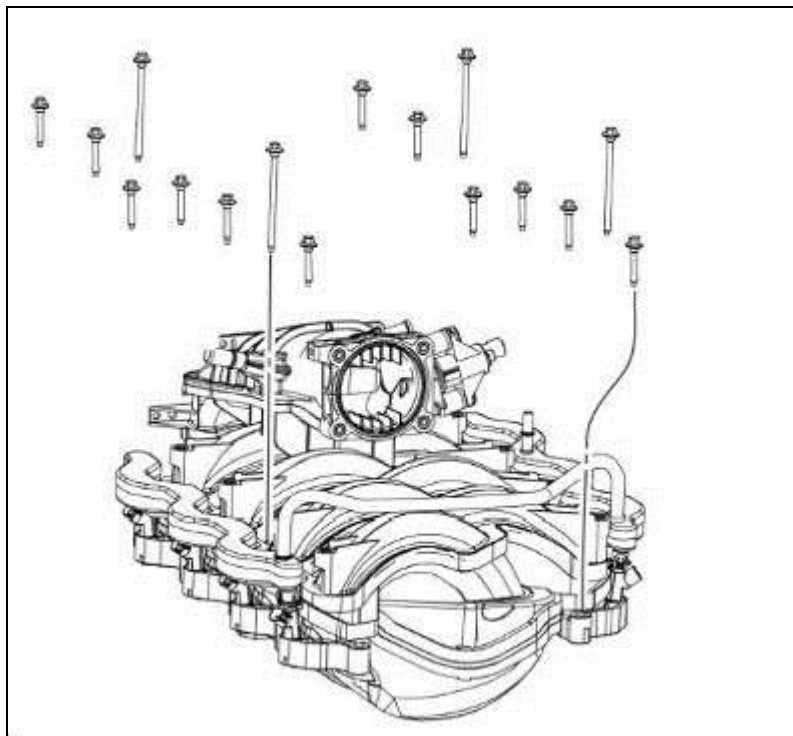



**PREMIUM FUEL REQUIRED – NOT E85 COMPATIBLE**

26. Clean the intake mounting surfaces and apply tape over the open intake ports to prevent engine contamination.
27. Remove the passenger side headlamp assembly (Note: Drivers side is shown in the pictures). First remove the air deflector retainer pin to the top inside corner of the headlamp assembly. Remove the three bolts securing the headlamp and pull forward to loosen the two metal clips. Once the lamp assembly is loose, disconnect the two electrical connectors and place the lamp aside.

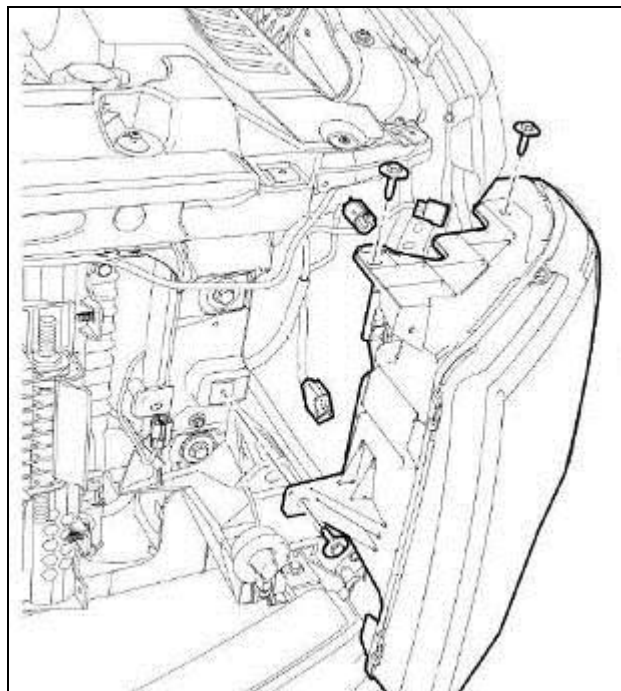
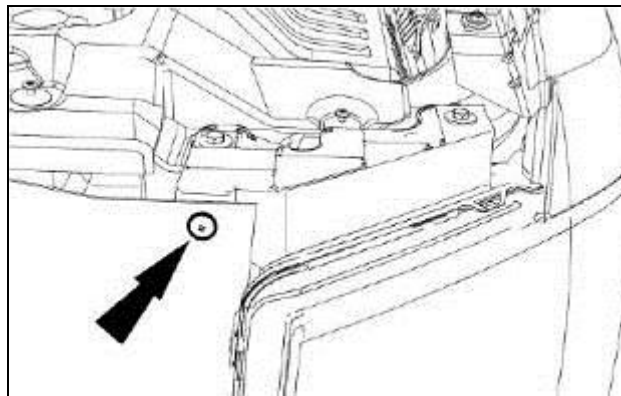



**PREMIUM FUEL REQUIRED – NOT E85 COMPATIBLE**

## SECTION B – MODIFICATIONS

The following section will guide you through the required modifications of existing components and build up of the assemblies used to complete the installation. With the exception of the wiring modifications, all of this work can be performed away from the vehicle.

### Airbox Modification

1. Remove the MAF sensor from the stock airbox cover and install into the new MAF tube (11SC-12B579) using the two factory fasteners. Torque screws to 1.8 – 2.2 Nm.

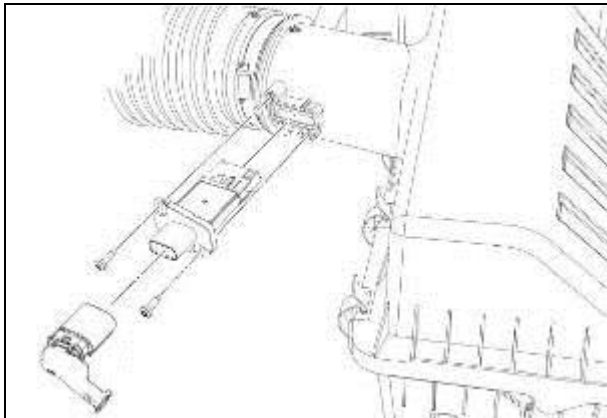

2. In order for the new airbox lid to be secured to the lower airbox tray properly, the retaining clip closest to the degas bottle needs to be modified. Remove the inboard clip from the tray and use a saw or grinder to remove part of the clip as shown. Deburr all sharp edges.

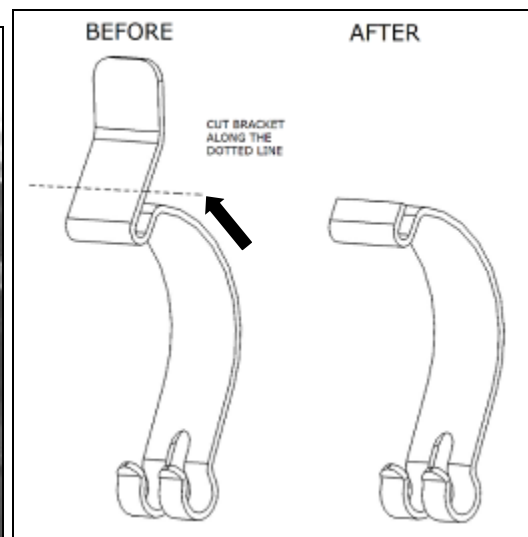
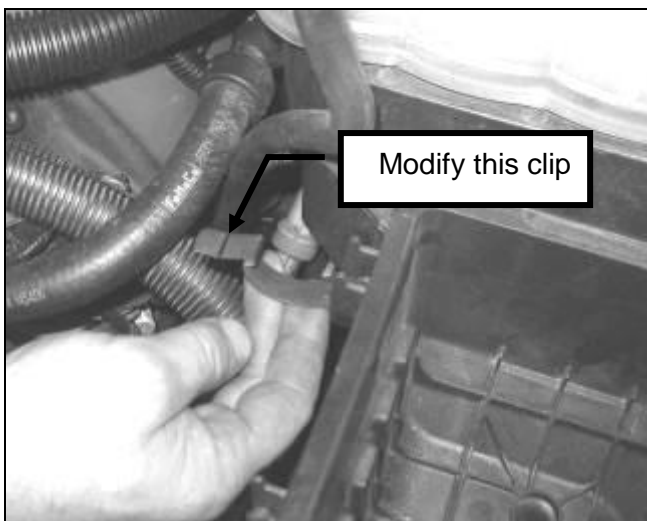



**PREMIUM FUEL REQUIRED – NOT E85 COMPATIBLE**

**Brake Booster Hose Modification**

1. Remove the factory brake booster hose and brake aspirator assembly that is still connected to the booster.

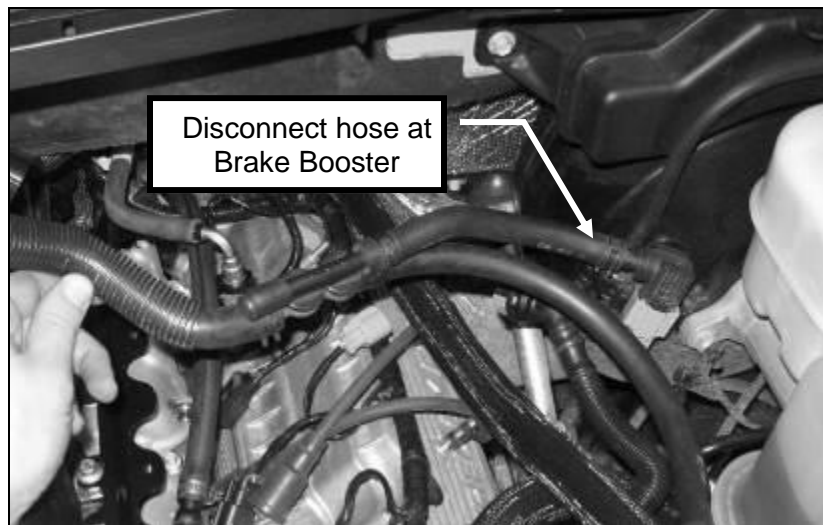

2. Lay the hose out on a workbench or flat surface as shown.







**PREMIUM FUEL REQUIRED – NOT E85 COMPATIBLE**

3. Cut the hose that connects the brake aspirator to the brake booster 75 mm from the end of the hose. Keep the 75mm length of cut off hose as it will be re-used. Rotate the hose 180° as shown.

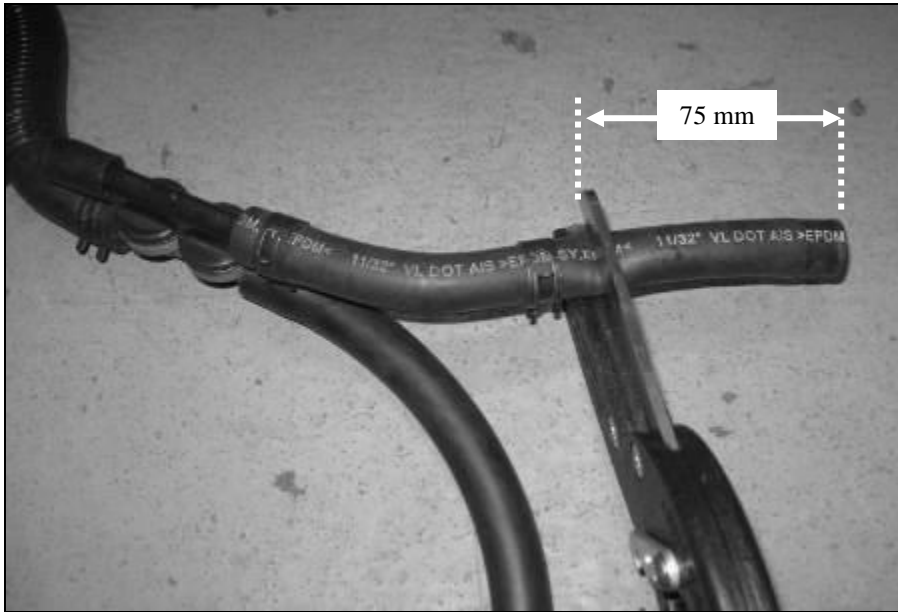

4. Insert the 1/2" to 3/8" adapter (5463K225) into the 1/2" hose still connected to the brake aspirator. Remove the clamp from the unused end of hose and clamp the adapter to the 1/2" hose using this clamp. Insert the 75mm length of 3/8" hose (cut in step 3) and insert this onto the opposite end of the adapter. Using two (2) worm drive clamps (62003), place one on either end of this 3/8" hose and tighten clamps to the hose.





**PREMIUM FUEL REQUIRED – NOT E85 COMPATIBLE**

5. Replace the convoluting that was on the larger ½” hose to cover the clamps.



**VMV Hose Modification**

1. Locate the fuel vapor hose beside the fuel supply line. At the joint where the tube transitions from steel to plastic, cut the VMV line in a vertical direction and remove the covered plastic portion from the steel line fixed in the vehicle.

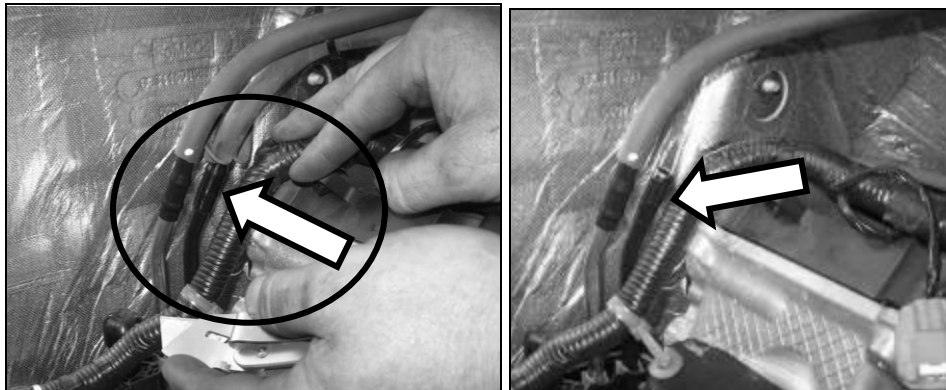



**PREMIUM FUEL REQUIRED – NOT E85 COMPATIBLE**

2. With the line removed from the vehicle, carefully cut along the opposite end of the hose where the fitting is inserted and remove the quick connect fitting from the hose.

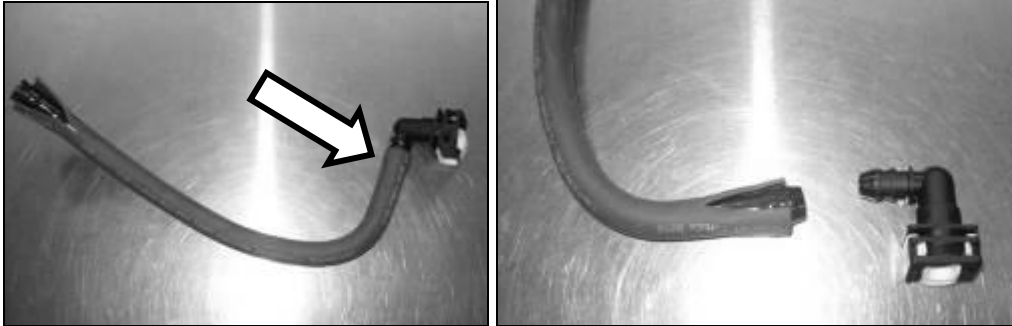

3. Install the quick connect fitting into one end of the new VMV hose (27004) and secure using one (1) worm drive clamp (62003).



4. Place the second worm drive clamp (62003) over the opposite end of the new VMV hose and install onto the steel line. Position the clamp so the screw (drive) side is closest to the cylinder head and tighten the clamp.

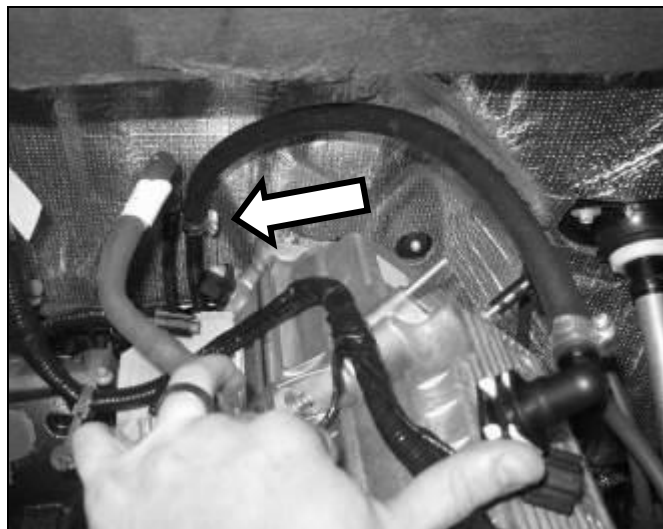



**PREMIUM FUEL REQUIRED – NOT E85 COMPATIBLE**

5. Cut a 4" length of split loom convolute provided in the kit. Insert this over the end of the VMV line connection so it covers the clamp between the fuel supply line and the VMV line. Tape the ends of the convolute to keep it in position.





## **PREMIUM FUEL REQUIRED – NOT E85 COMPATIBLE**

### **TPS/ETC Wiring**

1. Locate the Throttle Position Sensor (TPS) connector and harness at the rear of the engine compartment. Use a proper de-pinning tool to remove the connector from the harness.



2. Depress the locking tab and separate the “empty” female 1 x 6 connector from the new TPS/ETC Extension harness (131114A595). It will be used in the next step.





### **PREMIUM FUEL REQUIRED – NOT E85 COMPATIBLE**

3. Populate the new connector such that the yellow with violet wire is in position 1, the blue with green wire is in position 2, the brown wire is in position 3, the blue with orange wire is in position 4, the yellow wire is in position 5 and the green with violet wire is in position 6. Install the red plastic lock into the connector to secure the wires in place.

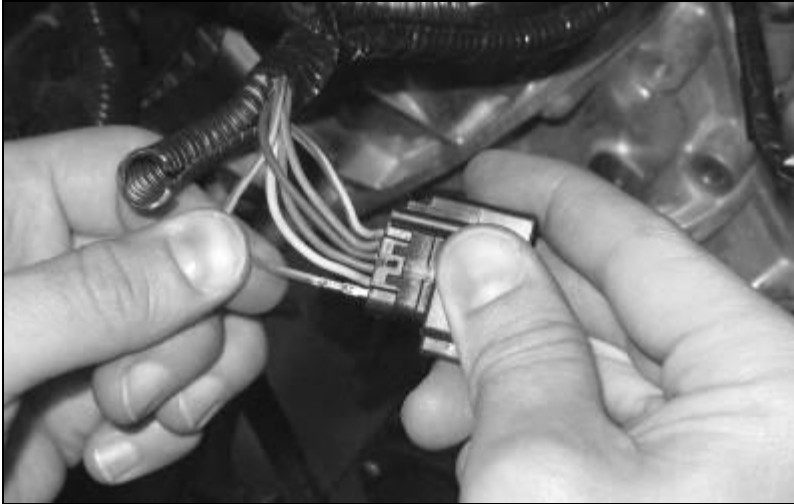

4. Connect the TPS/ETC extension harness to the newly installed connector. The wire colors on each side of the connector pair should align. Route the harness along the main wiring harness to the rear of the driver side cam cover. Use tape or zip ties to secure the extension harness to the main harness.





## PREMIUM FUEL REQUIRED – NOT E85 COMPATIBLE

### Canister Purge Valve Wiring

1. Locate the Canister Purge Valve electrical connector at the rear of the engine compartment. Remove and discard the 90 degree wire retainer. Use a proper de-pinning tool to remove the connector from the harness.

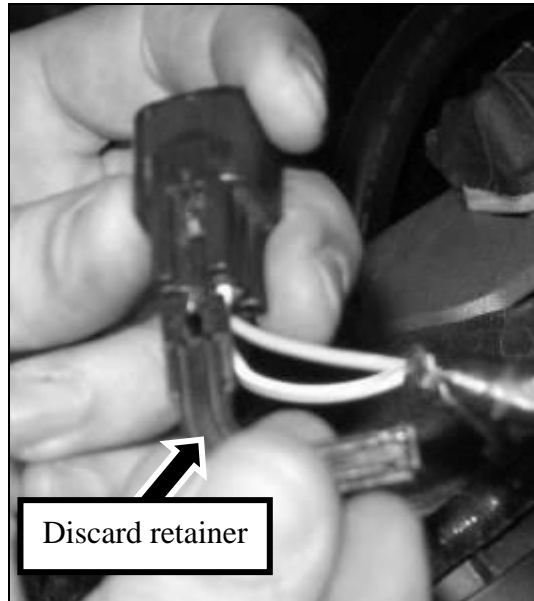

2. Depress the locking tab and separate the “empty” female 1 x 2 connector from the Canister Purge Valve Extension harness (13119G866). This connector replaces the connector removed in the previous step. **Carefully pull the white locking tab forward to allow wires to be installed into the connector.** Populate the new connector such that the white with brown wire is in position 1 and the green wire is in position 2. Depress the white locking tab to secure the wires.





**PREMIUM FUEL REQUIRED – NOT E85 COMPATIBLE**

3. Connect the Canister Purge Valve Extension harness to the newly installed connector. The wire colors on each side of the connector pair should align. Route the harness along the main wiring harness to the rear of the driver side cam cover. Use tape or zip ties to secure the extension harness to the main harness.







## **PREMIUM FUEL REQUIRED – NOT E85 COMPATIBLE**

### **Intercooler Pump Wiring**

1. With the battery removed, undo the three (3) bolts securing the battery box to the vehicle and set these bolts aside. Insert the M6 x 20 bolt (W500214) found in Hardware Kit D (11SC-TVSHKD) through the hole in the front corner of the now loose battery box from the inside facing out.

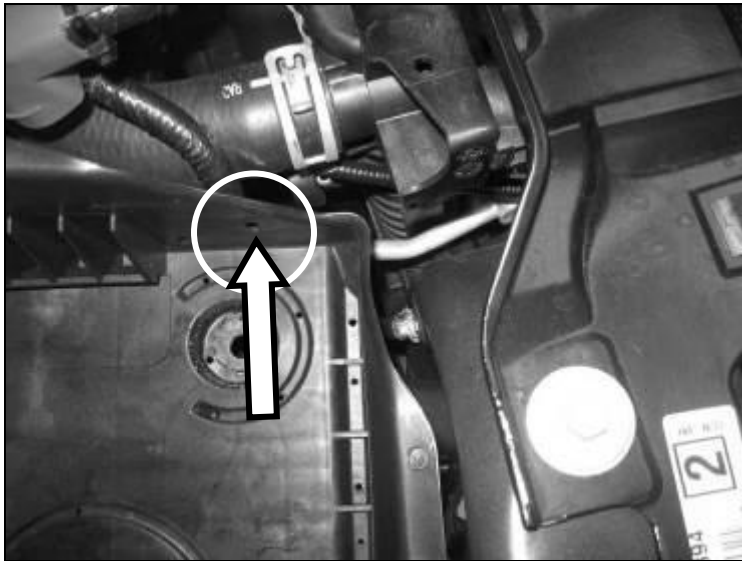

2. Install the relay from the Intercooler Pump Wiring Harness (13118W501) onto this bolt. Install the fuse on top of the relay onto the same bolt. Use the one (1) M6 nut (W520412) from the Intercooler Hardware Kit (11SC-TVSHKD) to secure the relay and fuse to the stud. Torque the nut to 10 Nm.

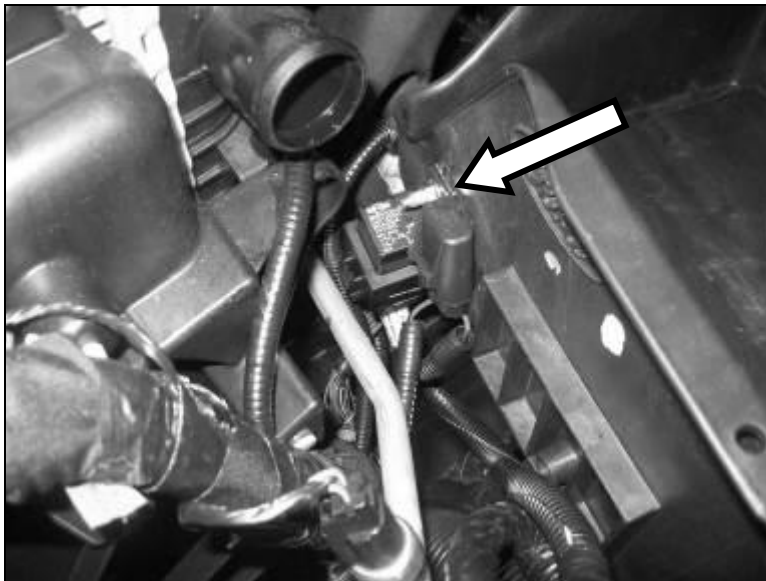



## PREMIUM FUEL REQUIRED – NOT E85 COMPATIBLE

3. Route the black ground wire coming from the relay toward the front radiator support. Remove the one (1) bolt securing the factory ground wire to the chassis along the radiator support. Insert the black ground wire from the I/C Pump harness and replace the bolt to secure the factory grounds including the grounding eyelet from with the intercooler pump harness. TIP: Access this bolt through the front opening where the headlamp assembly was. You won't be able to access the bolt if you do not loosen the battery box.

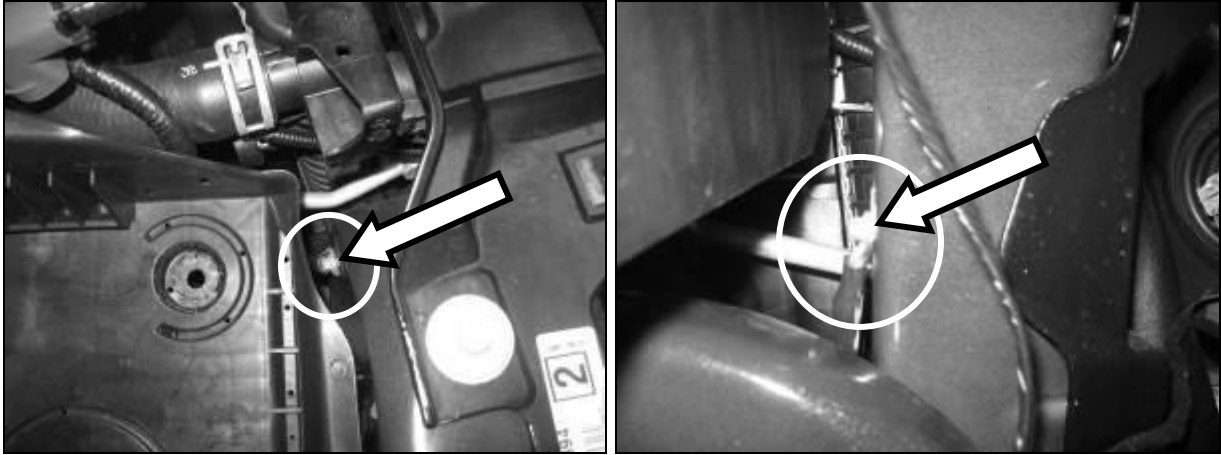

4. Route the red wire (part of the Intercooler Pump Wiring Harness installed above) to the connection on the positive terminal of the battery cable. Remove the nut from the positive terminal and install the red wire eyelet. Reinstall the nut onto the terminal. Torque to 10 Nm.

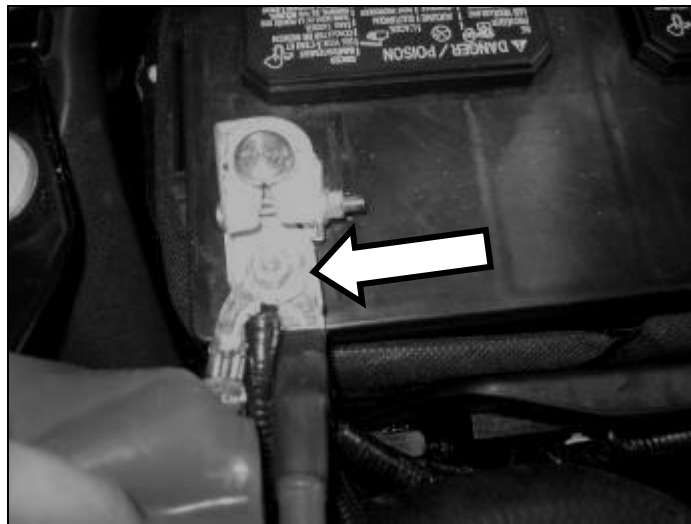

5. Route the single wire with the two electrical connectors along the factory engine harness to the front of the passenger side cylinder head.



**PREMIUM FUEL REQUIRED – NOT E85 COMPATIBLE**

6. Remove the nut that is retaining the radio capacitor on the stud in the top corner of the front cover on the passenger. Disconnect the radio capacitor from the engine harness, remove the radio capacitor and discard the nut.

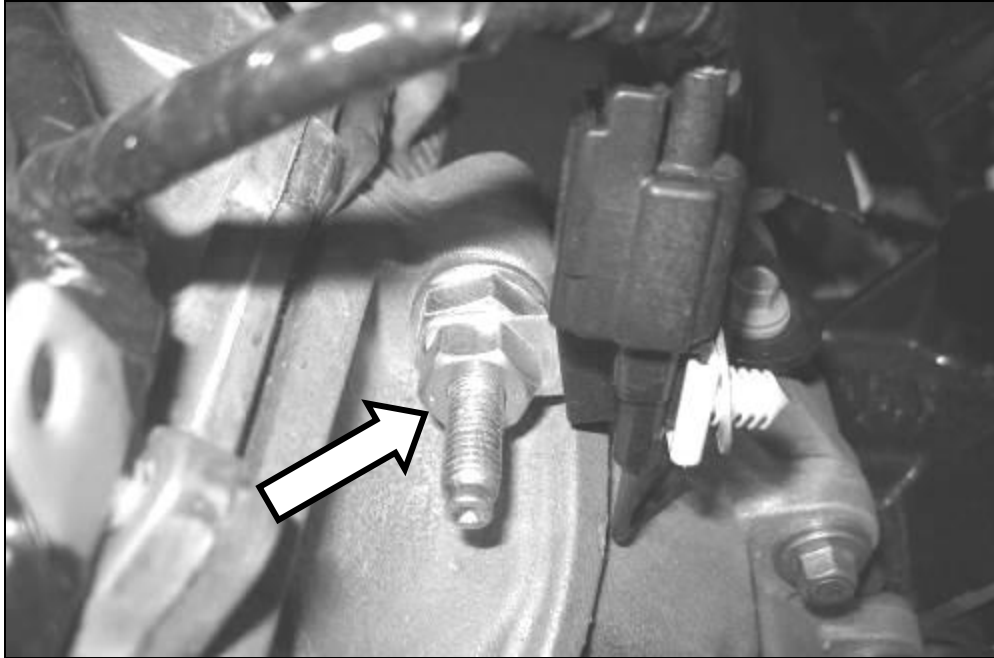

7. If your vehicle is a 2011 model year, follow steps 7 thru 9. For a 2012-2013 model year, proceed to step 10. Undo the engine harness that is clipped to the front wiring harness retention stud. Insert one (1) M6x1.0 Nut upside down, onto this wiring retention stud in the cam cover.

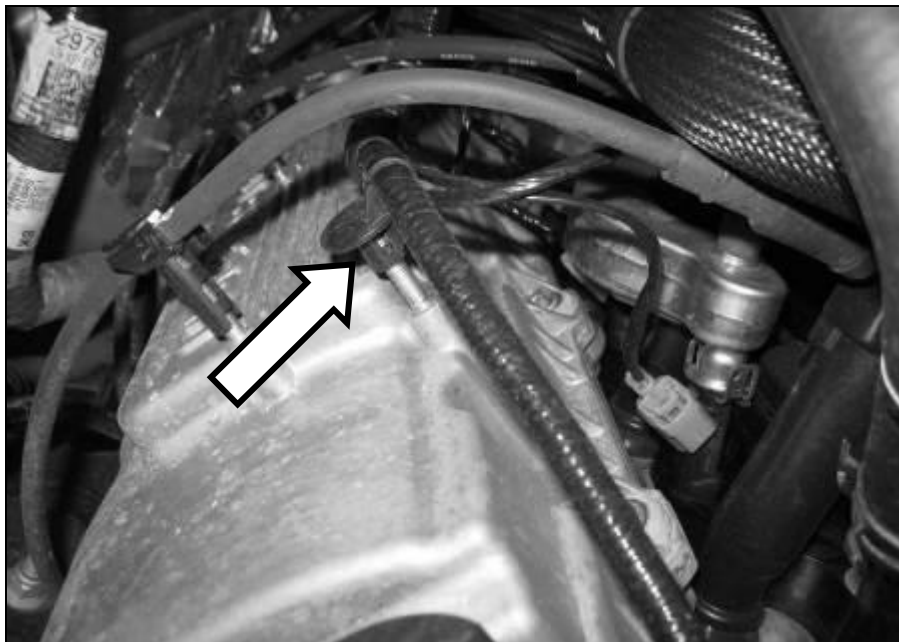



**PREMIUM FUEL REQUIRED – NOT E85 COMPATIBLE**

8. Insert the radio capacitor over the stud and onto the nut. Insert one (1) M6 x 1.0 nut onto the stud, securing the radio capacitor into position. NOTE: Do not over tighten as the stud in the cam cover will loosen. Re-install the engine harness onto the top of the stud.

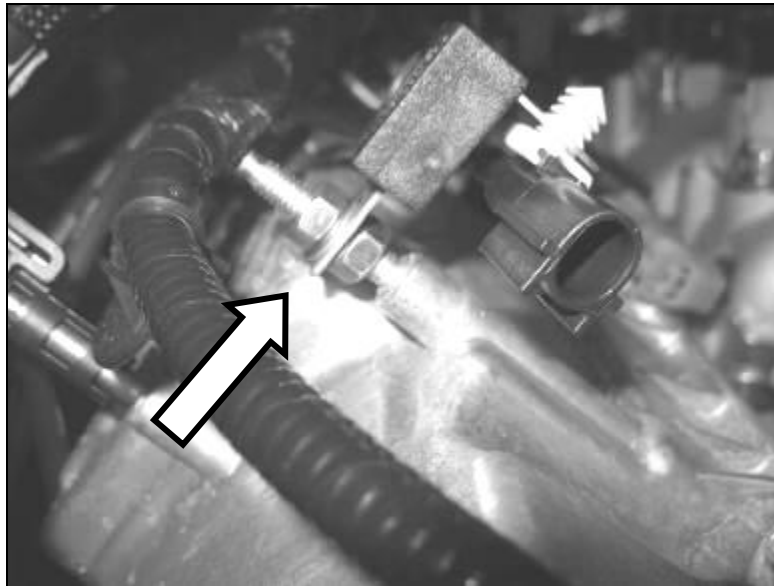

9. Connect the two connectors coming from the intercooler pump harness into the passenger side radio capacitor and re-connect the engine harness into the opposite connector. The single connector of the harness will be routed down to the intercooler pump in Section D of this manual.

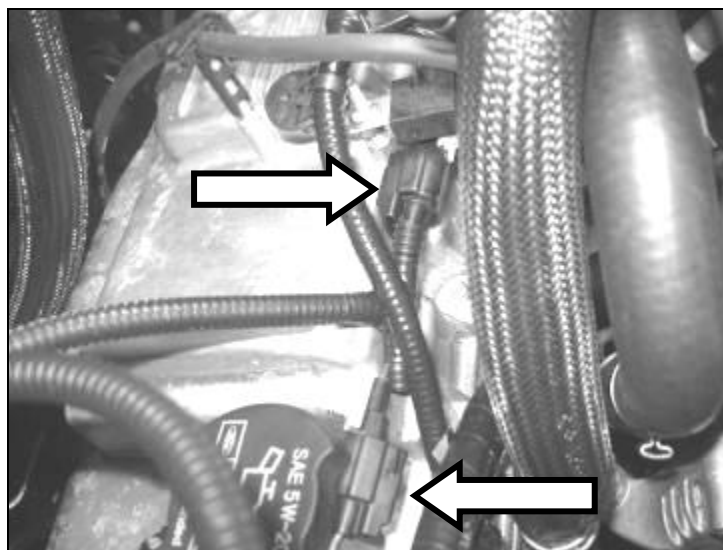

10. For 2012-2013 model year vehicles, you will re-install the radiator capacitor in a later step. Connect the two connectors from the intercooler pump harness into the passenger side radio capacitor and re-connect the engine harness into the opposite connector. Place the radio capacitor on the passenger side cam cover for later installation.



## PREMIUM FUEL REQUIRED – NOT E85 COMPATIBLE

### Air Charge Temperature (ACT) Wiring

1. You will be working with the far left 70 pin or "cowl" connector. (See figure 1 below).

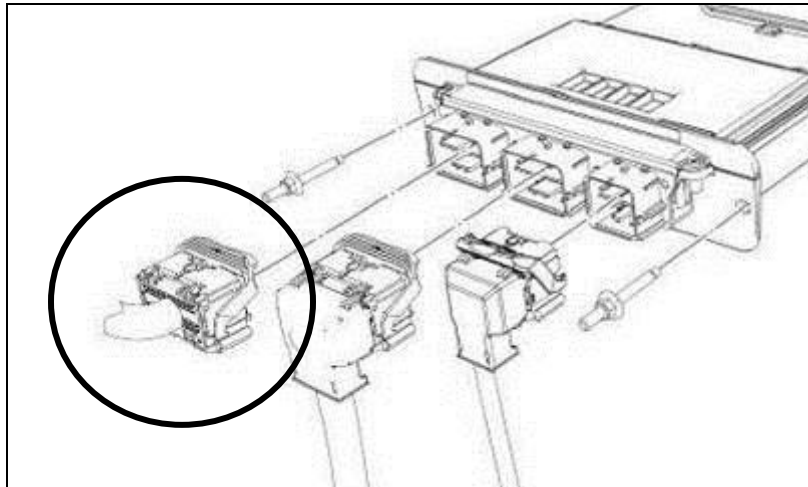
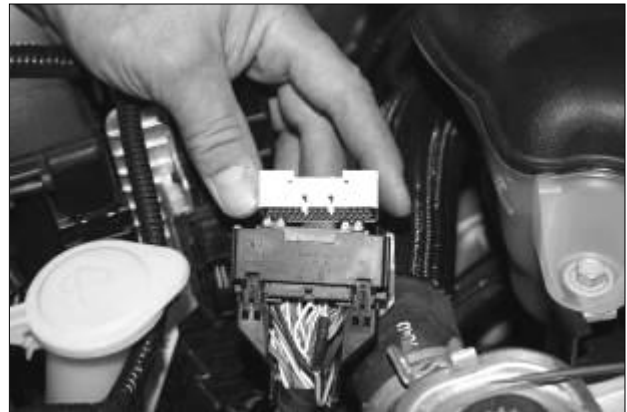

**Figure 1**

2. a) Remove the pin locking device as shown in figures 2 and 3. Also remove the wire support on the back of the connector (figure 5) by removing the tape and using a small screwdriver to lift the locking tabs.



**Figure 2**

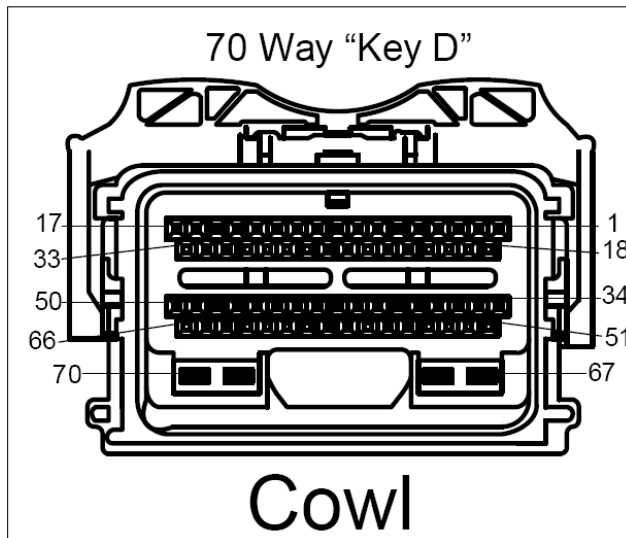

**Figure 3**

The ACT Harness (131112A690) will have the ACT sensor connector at one end. On the other end will be 2 wires, one with a blunt end and the other with a pin already crimped on. The blunt wire will be spliced into the wire located in pin C-56 of the cowl connector. The wire with the pin will be inserted into location C-36 of the cowl connector. There are small numbers on the back of the connector noting location. Figure 4 below will also help to identify the pin locations.



**PREMIUM FUEL REQUIRED – NOT E85 COMPATIBLE**



**Figure 4:** PCM Pin Locations for Cowl Connector – Front View (side that connects to PCM)

b) Remove pin C-56 from the connector by **gently** moving the locking tab away from the pin on the front of the connector and pulling the wire out of the back of the connector. Remove the insulation from a 1/2" section of the pin C-56 wire and 1/2" of the end of the blunt wire on the ACT loom. Solder the two wires together and seal them with the supplied shrink wrap. Reinsert the spliced wire into the C-56 location. Note the orientation of the pins on the front of the connector and reinstall the pin in the same way. If the pin is turned it will not lock. The finished/inserted splice is shown in figures 5 and 6 (green wire with black shrink wrap).

c) Insert the ACT loom wire with the pin into the empty C-36 location of the connector. The back of the connector may have a blank cover at the C-36 location. **Carefully** push this blank cover in with a small screw driver or punch to allow you to insert the pin. Note the orientation of the pins on the front of the connector and install the new pin in the same way.



**Figure 5**



**Figure 6**

3. a) Reinstall the pin locking device by snapping it into place. Reinstall the wire support on the back of the connector and wrap with tape as before.

b) Reconnect the PCM connector and route the ACT loom wire along the engine harness over to the PCM



## **PREMIUM FUEL REQUIRED – NOT E85 COMPATIBLE**

### **Knock Sensor Orientation Adjustment**

1. Loosen the two bolts which retain the knock sensors to the engine block and rotate the RH and LH knock sensor toward the RH and LH cylinder heads respectively. Torque the knock sensor bolts to 25Nm.

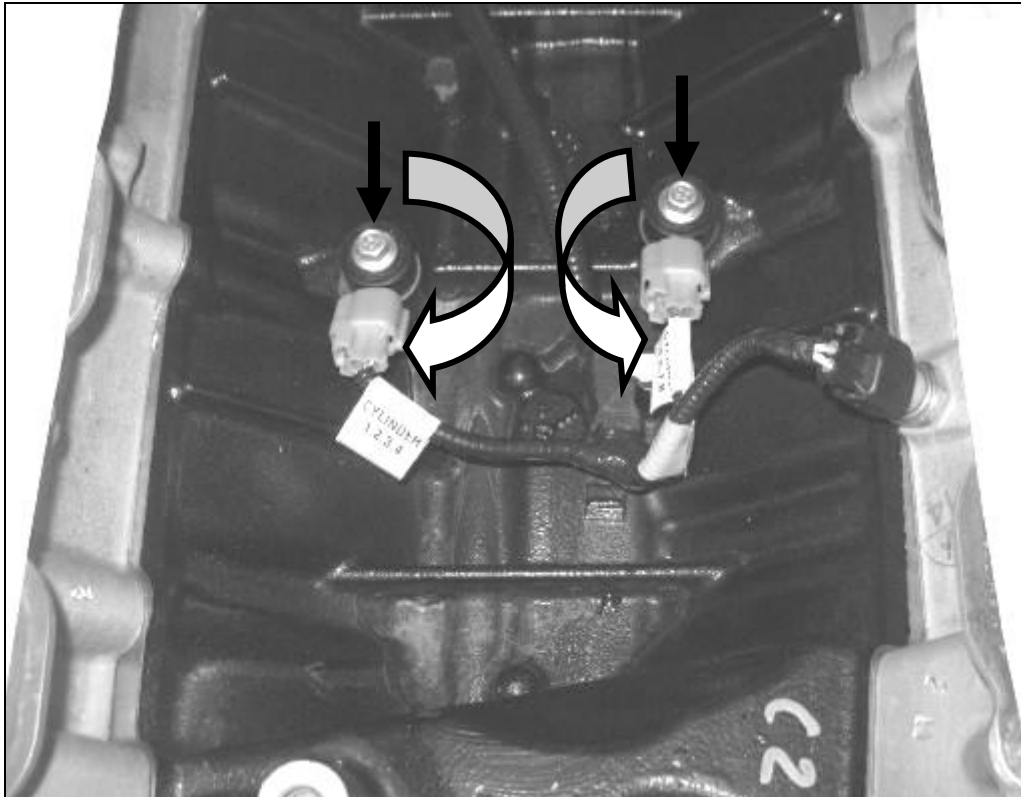



## **PREMIUM FUEL REQUIRED – NOT E85 COMPATIBLE**

### **Alternator B+ Post Modification**

1. Re-install the B+ cable nut (to protect the threads of the stud) and remove 10mm of material from the plastic wire position retainer on the alternator.

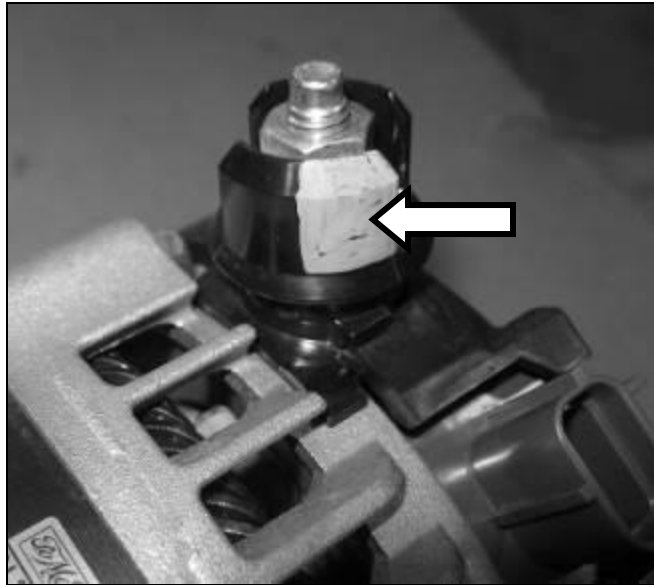

2. The finished modified part should look like the following. Remove any burrs or sharp edges and set aside for re-assembly.







**PREMIUM FUEL REQUIRED – NOT E85 COMPATIBLE**

## **SECTION C – SUBASSEMBLY**

### **Intercooler Low Temperature Radiator (LTR)**

1. Position the Low Temp Radiator – (LTR) (13108K229) on your workbench as shown. With the 90° fitting on your left facing up and the 90° fitting on your right facing to the right.

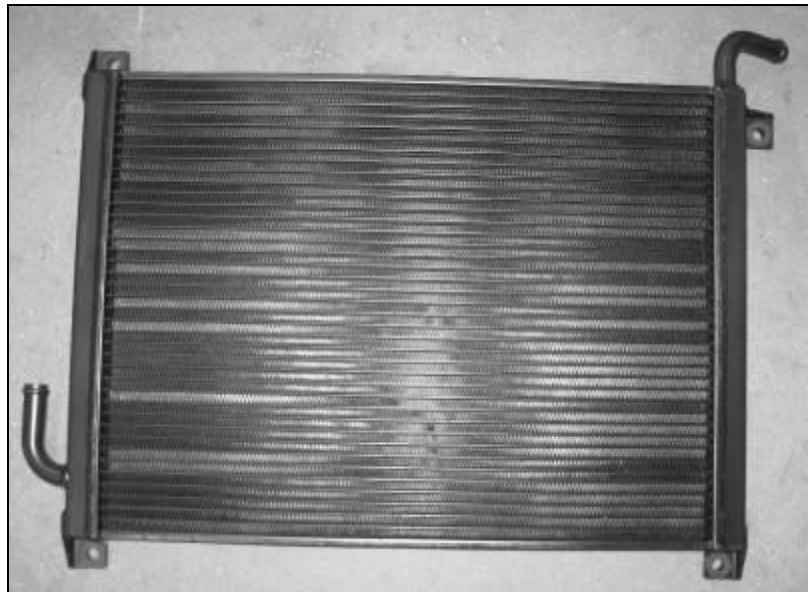

2. Insert one grommet (R07060107) into each of the four mounting holes at each corner of the LTR. With each grommet in place, position one steel grommet insert (R07060108) inside each grommet as shown. These can be found in Hardware Kit F (11SC-TVSHKF).





**PREMIUM FUEL REQUIRED – NOT E85 COMPATIBLE**

3. Position each of the LTR Mounting Brackets found in Hardware Kit F (11SC-TVSHKF) into the positions as shown. Loosely install one M8 x 25 bolt (N808920) from Hardware Kit F through the front of each of the grommet inserts and secure to the weld nut on the brackets (Four places).

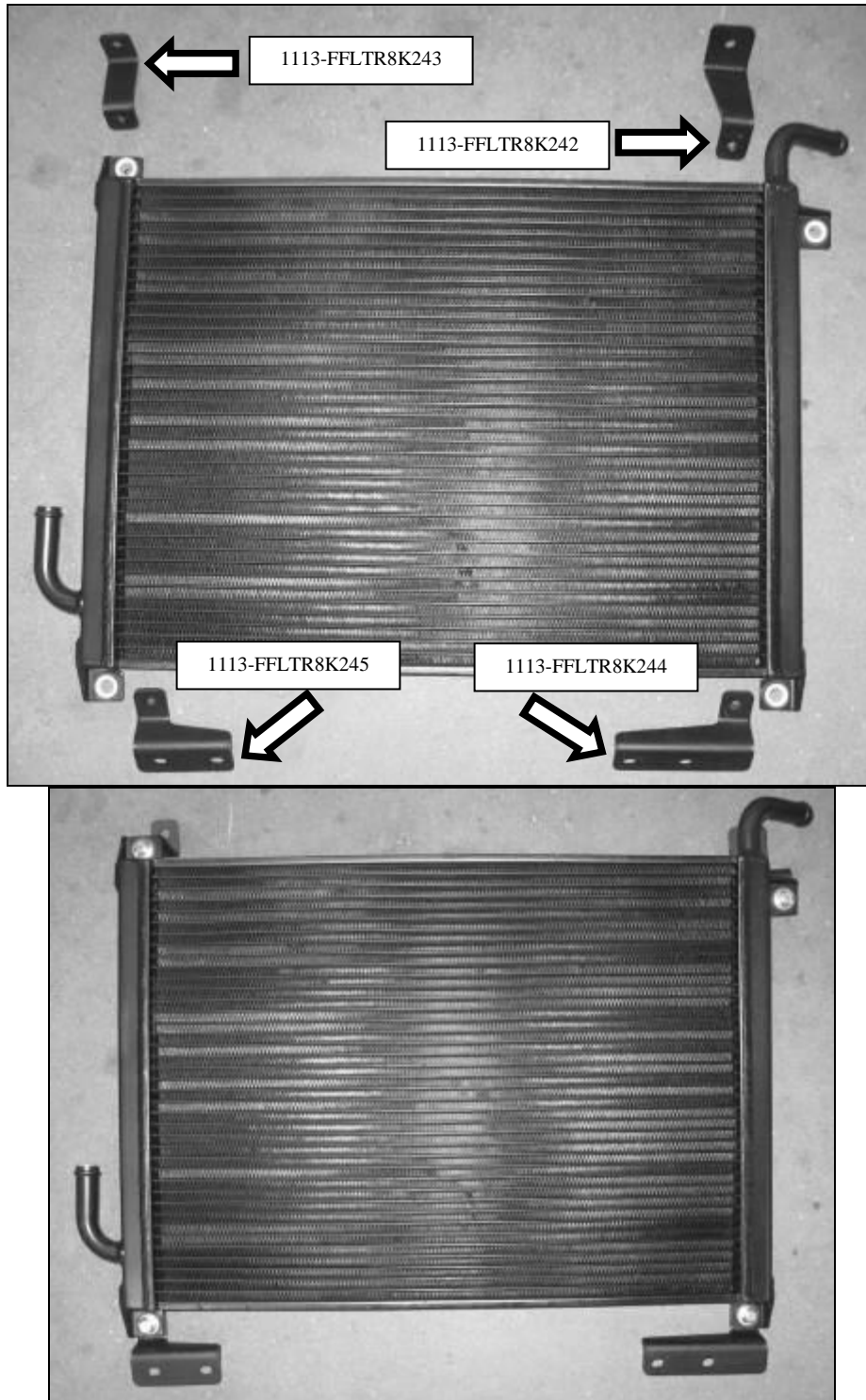



**PREMIUM FUEL REQUIRED – NOT E85 COMPATIBLE**

4. Place the LTR Cross Brace (1111-8K241) on your work bench as shown. Loosely install the I/C Pump Mounting bracket (1111-8C419) to the corner of the bracket as shown using one M8 x 25 bolt (N808920) from Hardware Kit D at the top. Loosely install the Lower RH LTR Mounting Bracket (1111-8K245) to the lower RH corner of the I/C Pump Mounting bracket as shown, using one M8 x 25 bolt (N808920) from Hardware Kit D.

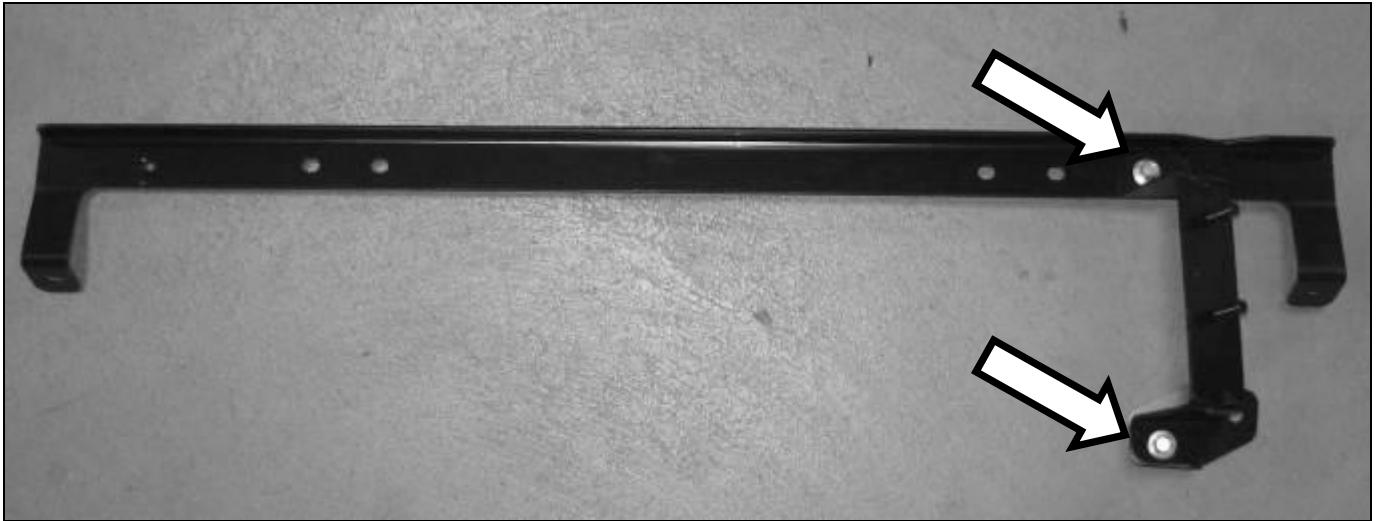

5. Install the I/C Pump (392022009) to the I/C Pump Mounting bracket and secure using two (2) M8 nuts (W520413) found in Hardware Kit D. Position the pump so the inlet is facing up. Torque the nuts to 25 Nm.

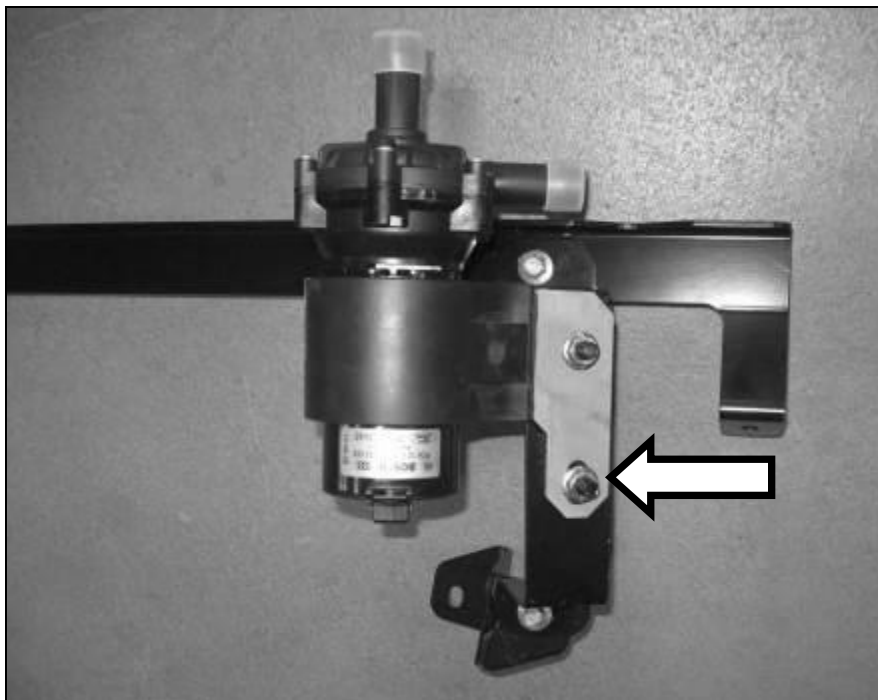



**PREMIUM FUEL REQUIRED – NOT E85 COMPATIBLE**

**Intake Manifold Build Up**

1. Remove the Fuel Charging Assembly (1162-9H487) from the packaging.
2. Attach the Bubbler hose (RR07060175) to the fitting (3/8" barb) on the bottom of the fuel charging assembly and secure it with the supplied clamp.

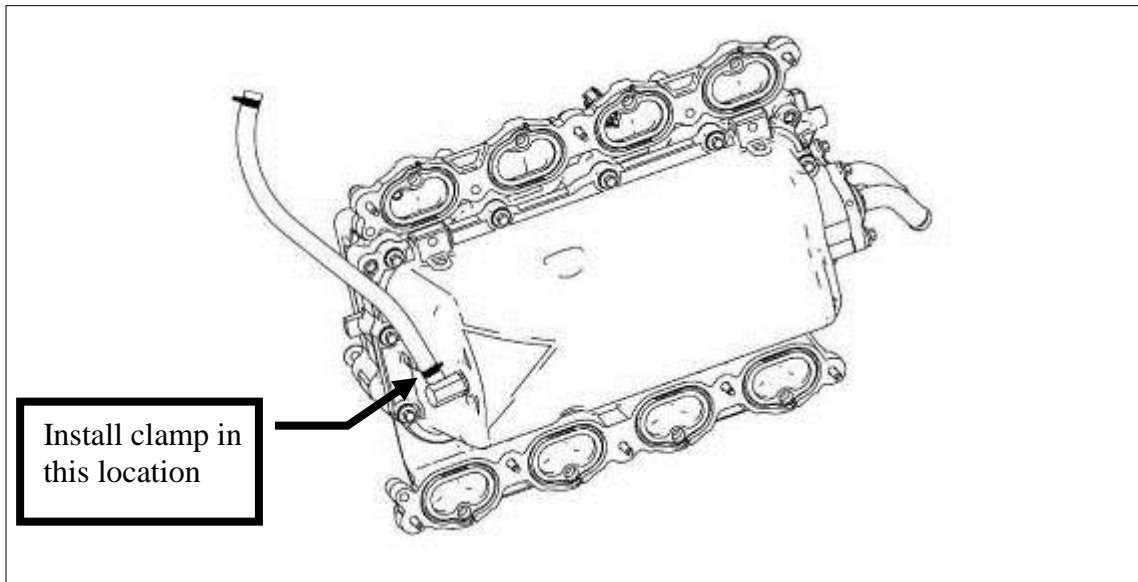



**PREMIUM FUEL REQUIRED – NOT E85 COMPATIBLE**

### Throttle Body Spacer Assembly

1. Remove the Evaporative Emission Canister Purge Valve from the stock intake manifold.

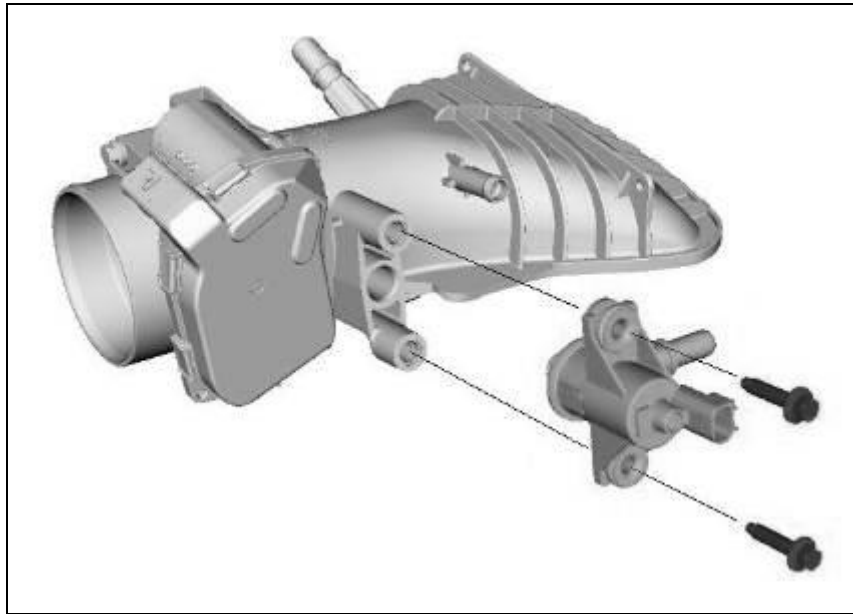

2. Install the VMV valve into the new Throttle Body Spacer (1162-9A589) and secure using the two take off bolts. Torque bolts to 10 Nm.





**PREMIUM FUEL REQUIRED – NOT E85 COMPATIBLE**

3. Connect the supercharger boost bypass actuator hose (short 4" hose - R18140001) to the straight fitting on throttle spacer.

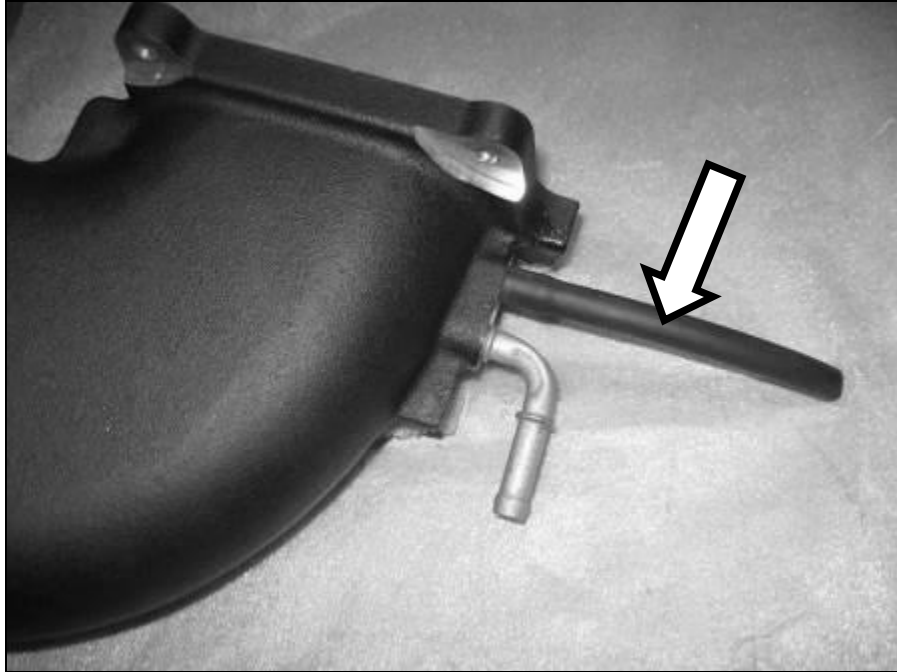

4. Connect the modified brake booster hose to the 90° tube on the throttle body spacer. This will be connected to the brake booster once the throttle spacer is installed.

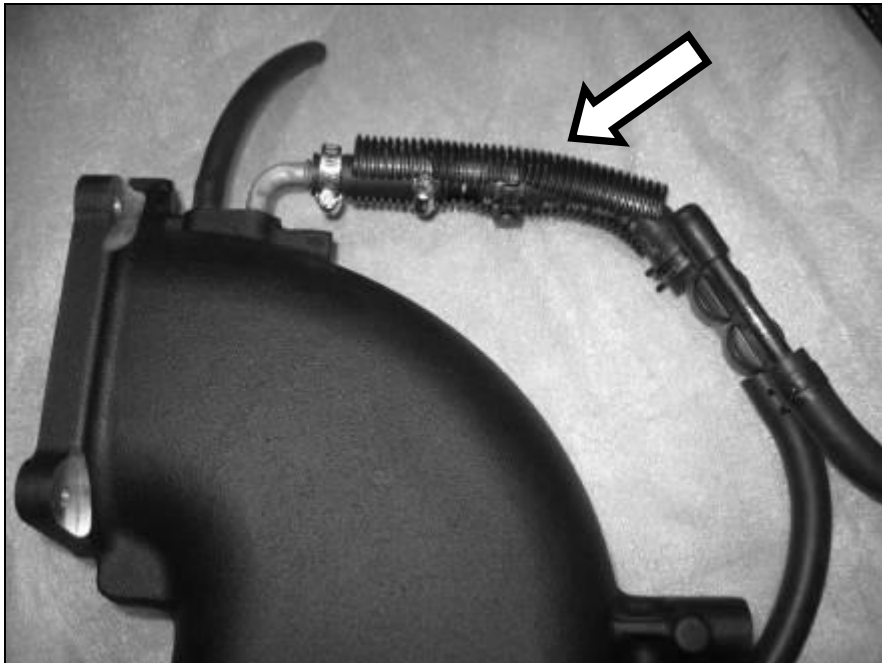



**PREMIUM FUEL REQUIRED – NOT E85 COMPATIBLE**

5. Insert the supercharger to throttle body spacer gasket (R07060152) into the machined groove on the throttle body spacer.

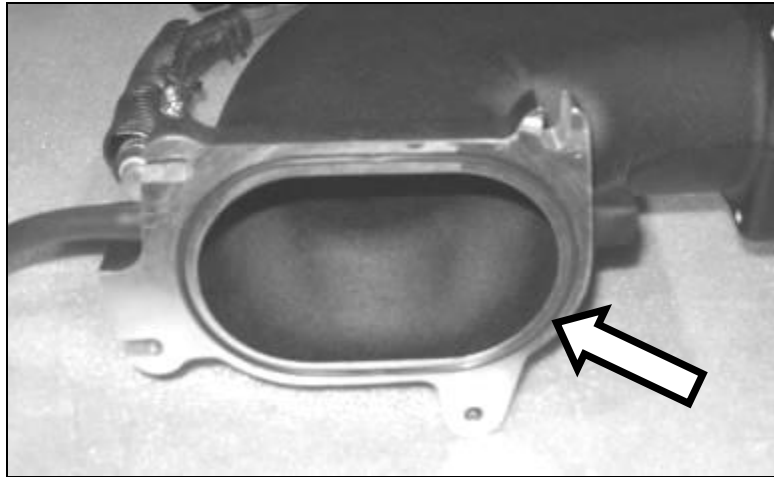

6. Insert the throttle body spacer to throttle body gasket (R07060153) into the machined groove on the throttle body spacer.

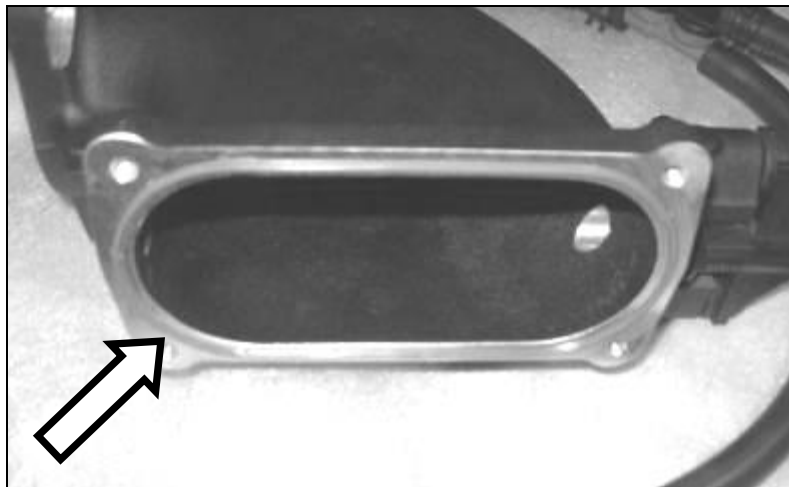



**PREMIUM FUEL REQUIRED – NOT E85 COMPATIBLE**

### Fuel Rail Assembly

1. Carefully install the eight (8) take off Anti-Rotation fuel injector Clips onto the new fuel injectors (provided).

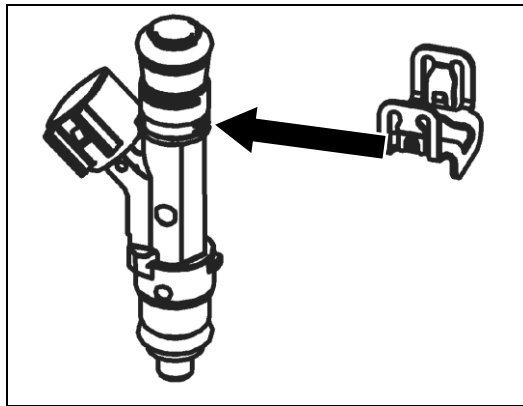

2. Apply assembly lube to the injector O-rings and install the injectors into the new Fuel Rail (1162-9F792). **NOTE:** Verify that the anti-rotation clips are properly aligned and fully engaged into the fuel rail injector cups.

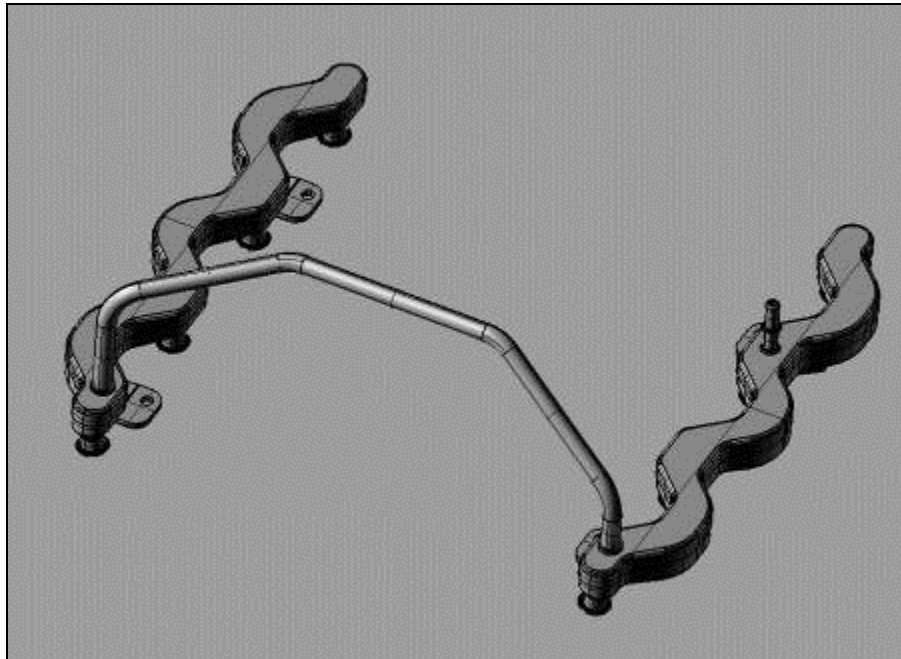





**PREMIUM FUEL REQUIRED – NOT E85 COMPATIBLE**

## **SECTION D – INSTALLATION**

The following section will guide you through the final installation of the kit into the vehicle. If you need to stop during any part of the installation, make sure you cover any open ports in the cylinder heads or intake manifold to prevent foreign material from contaminating your engine.

### **Intercooler Reservoir Mounting**

1. Remove the two RH (Passenger Side) front strut mounting nuts shown.

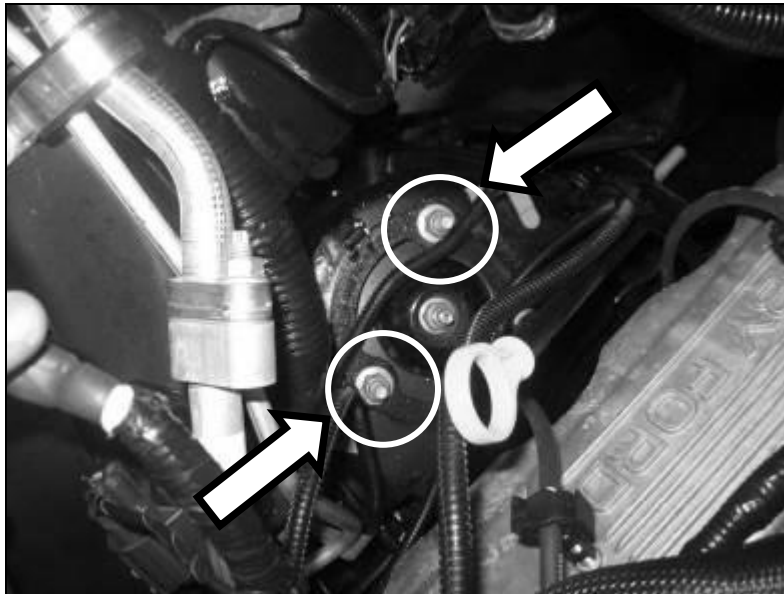

2. Place the Lower Degas Bottle Mounting bracket (1162-6B634L) on the top of the bracket on top of the strut mounting surface and re-install the two nuts. Torque to 40 Nm.

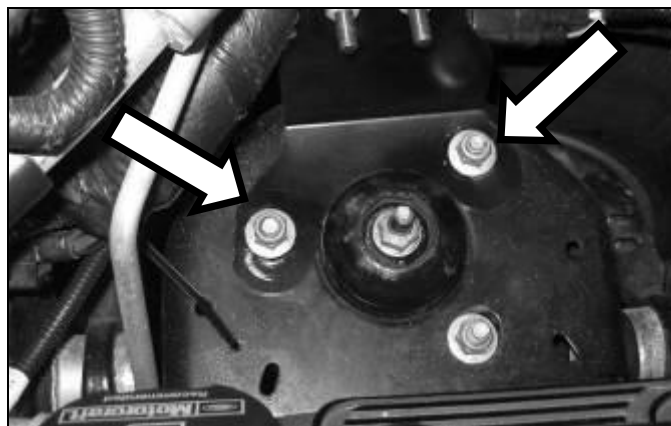



**PREMIUM FUEL REQUIRED – NOT E85 COMPATIBLE**

3. Position the Upper Degas Bottle Mounting bracket (1111-6B634U) over the two studs on the Lower Degas Bracket previously installed. Install two (2) M8 nuts (W520413) found in Hardware Kit E, onto the studs and torque to 25Nm.

Note: 4x2 trucks should position the upper bracket in the lower holes on the bracket. 4x4 trucks should position the upper bracket in the upper holes on the bracket.

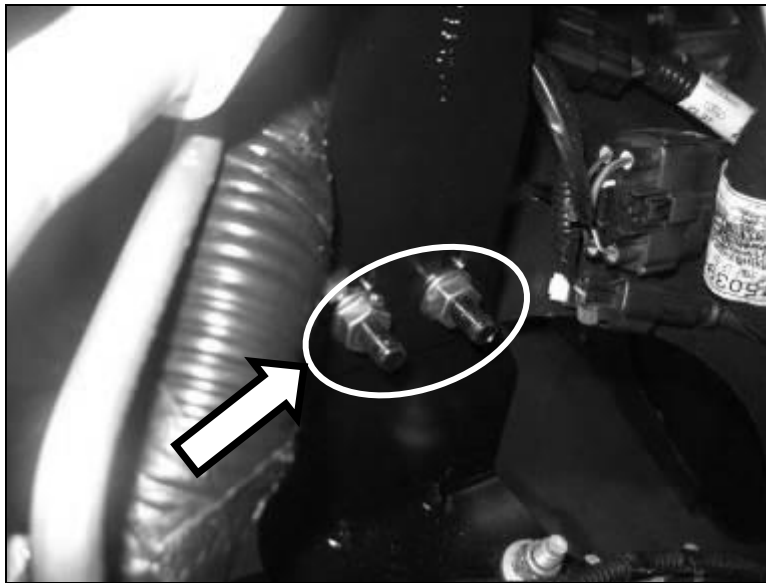

4. Remove the bolt securing the A/C line to the inner fender. Insert a 3-4" length of convoluting over the wire harness in the area shown to prevent chaffing between the bracket and the wiring.

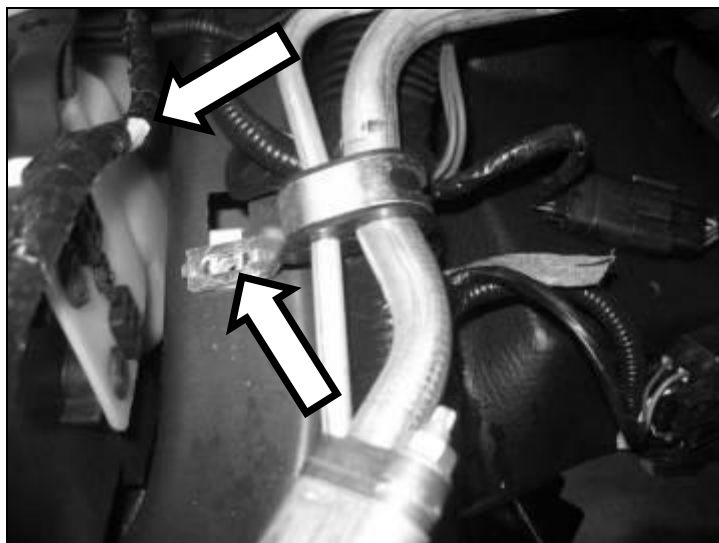



**PREMIUM FUEL REQUIRED – NOT E85 COMPATIBLE**

5. Place the Fender to Degas Bottle mounting bracket (1111-6B633) into position as shown and re-install the bolt that retains the A/C line clamp. Torque to 10 Nm.

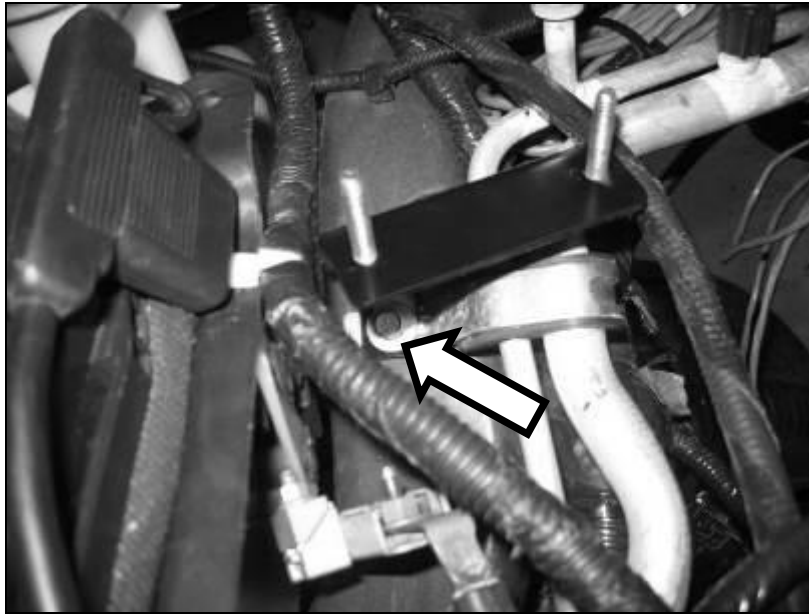

6. Install the Degas Bottle (R07070007) over the two studs on the Fender Mounting Bracket. Install two (2) M6 nuts (W520412) found in Hardware Kit E, over the studs and torque to 10Nm.

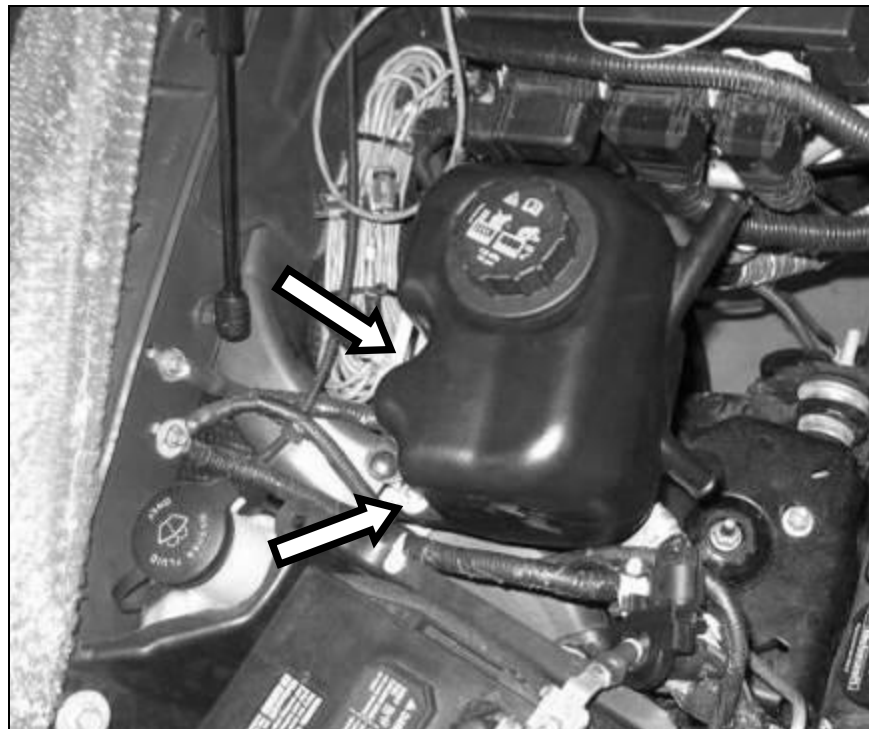



**PREMIUM FUEL REQUIRED – NOT E85 COMPATIBLE**

7. Insert one (1) M6x1.0x8 Socket Head Cap Screw (R18020010) found in Hardware Kit E into the mounting hole on the bottom side of the degas bottle, to retain the degas bottle to the strut mounted bracket.

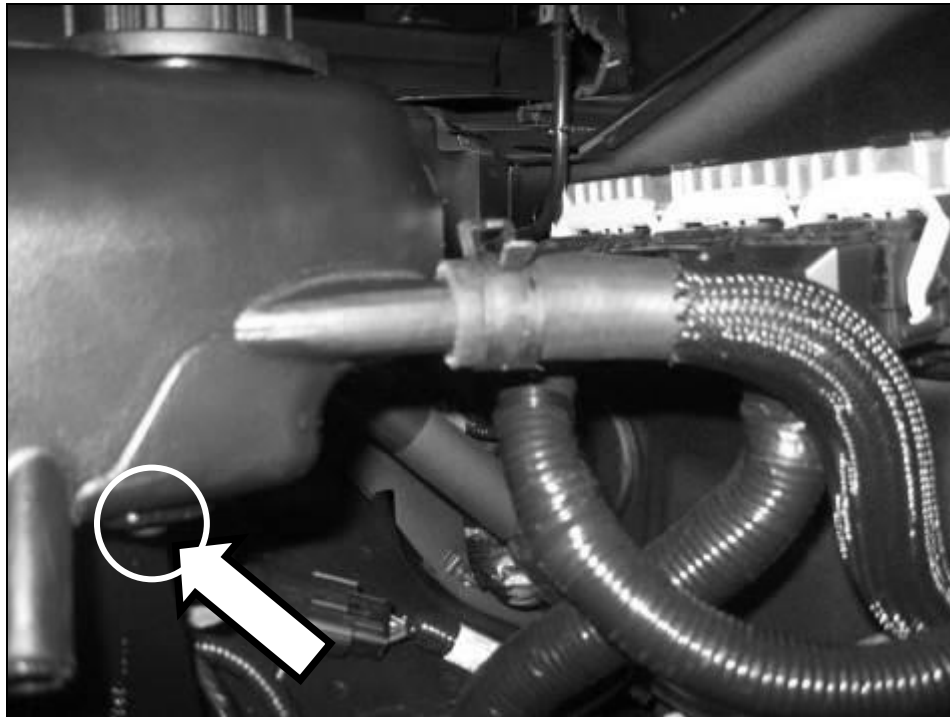



**PREMIUM FUEL REQUIRED – NOT E85 COMPATIBLE**

**Intercooler Radiator Assembly Mounting**

1. Install the Upper LH LTR Mounting Bracket (1111-8K242) into the vehicle by removing the bolt underneath the bumper cover to the side of the hood release (LH side of vehicle). Re-install the bolt and position the bracket as shown. Torque bolt to 25 Nm.

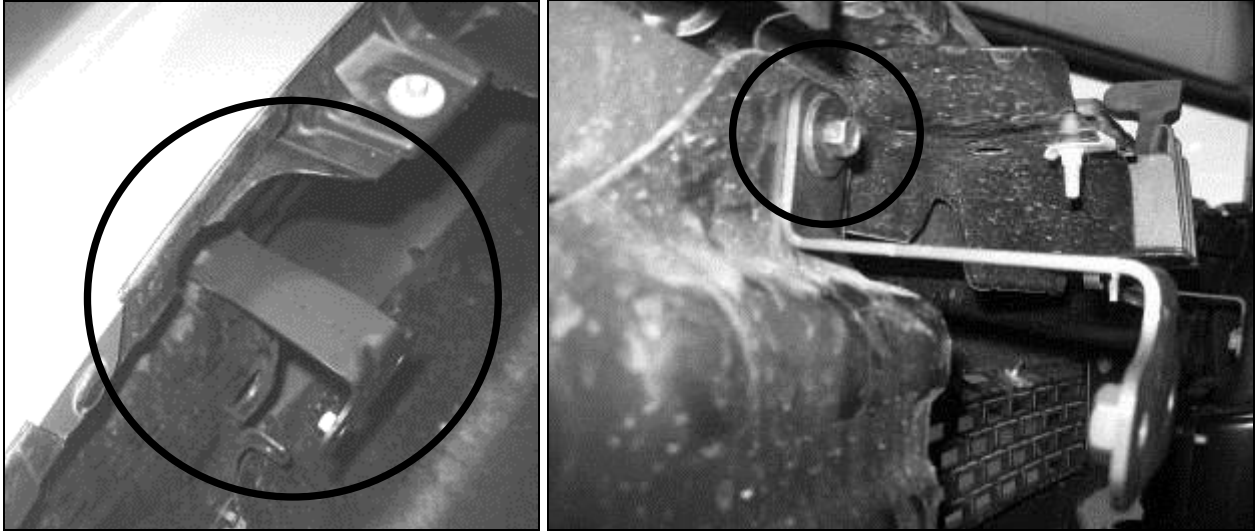

2. Install the Upper RH LTR Mounting Bracket (1111-8K243) into the vehicle by removing the bolt underneath the bumper cover to the side of the hood release (RH side of vehicle). Position the bolt as shown and re-install the bolt. Torque bolt to 25 Nm.

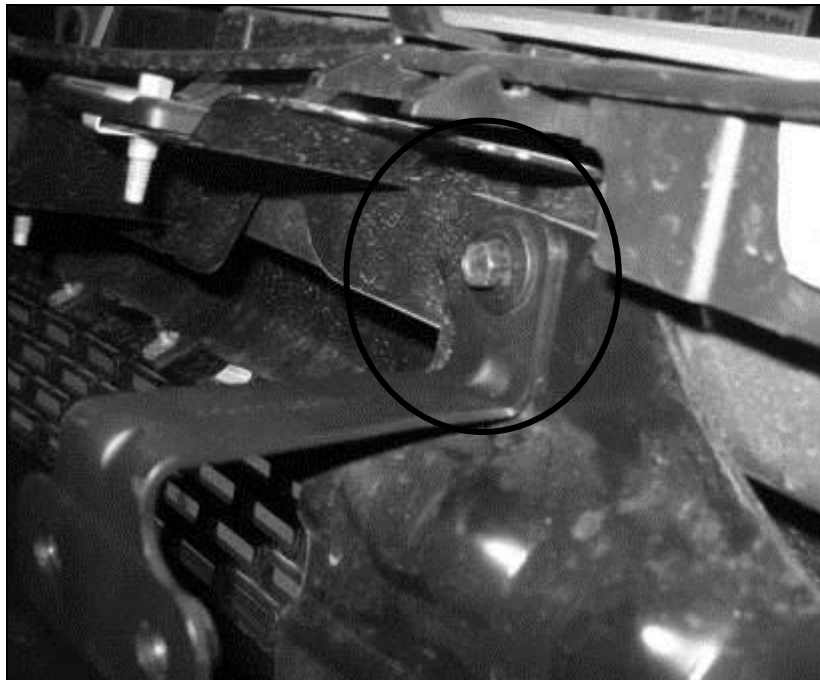



**PREMIUM FUEL REQUIRED – NOT E85 COMPATIBLE**

3. With the two upper LTR mounting brackets installed it will look like this.

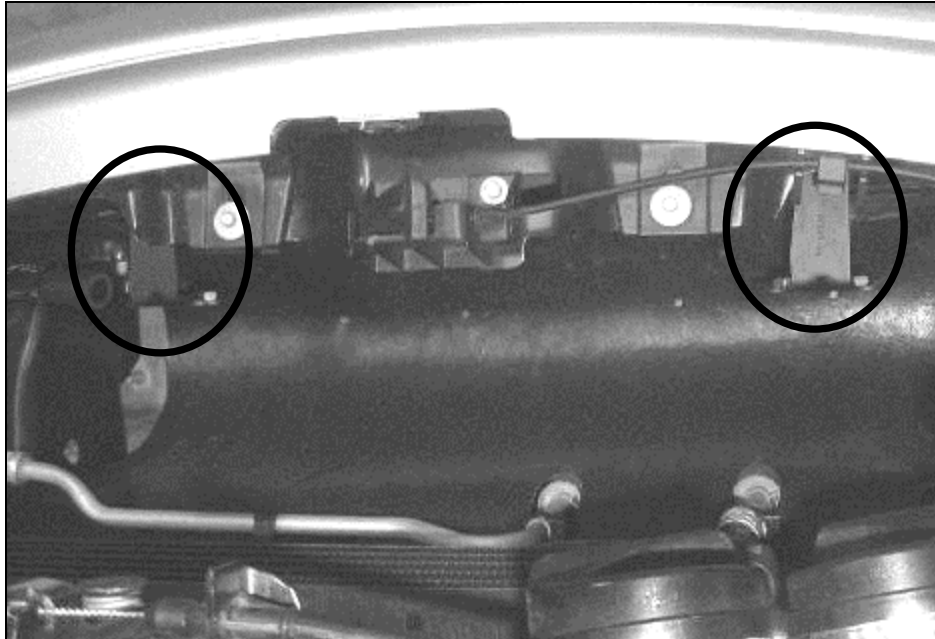

4. Remove the bolt that will retain the Lower LTR Mounting bracket on the passenger side. This is located directly below the Upper LTR Mounting bracket that was installed in the previous step. The air deflection shield may need to be moved aside for proper fitment. This bolt will be re-used.

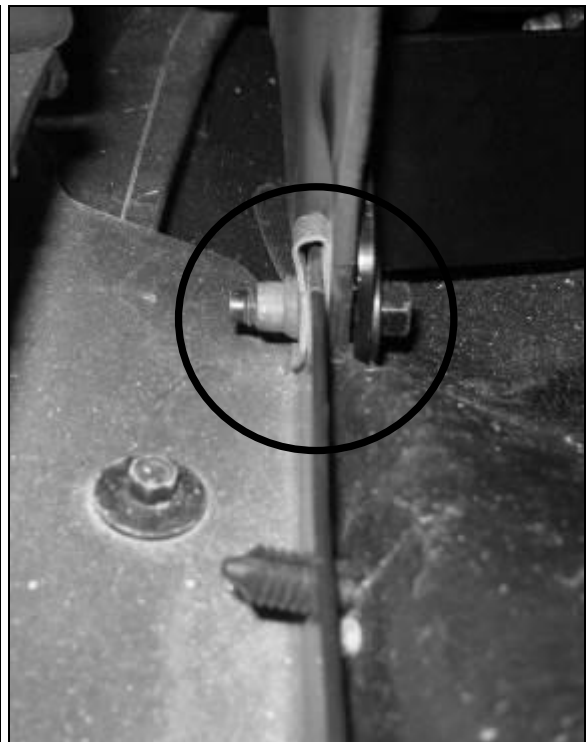



**PREMIUM FUEL REQUIRED – NOT E85 COMPATIBLE**

5. Using a trim tool, remove the plastic push pin retainers that are holding the air deflector shields in place at the front corner of the frame on both sides.

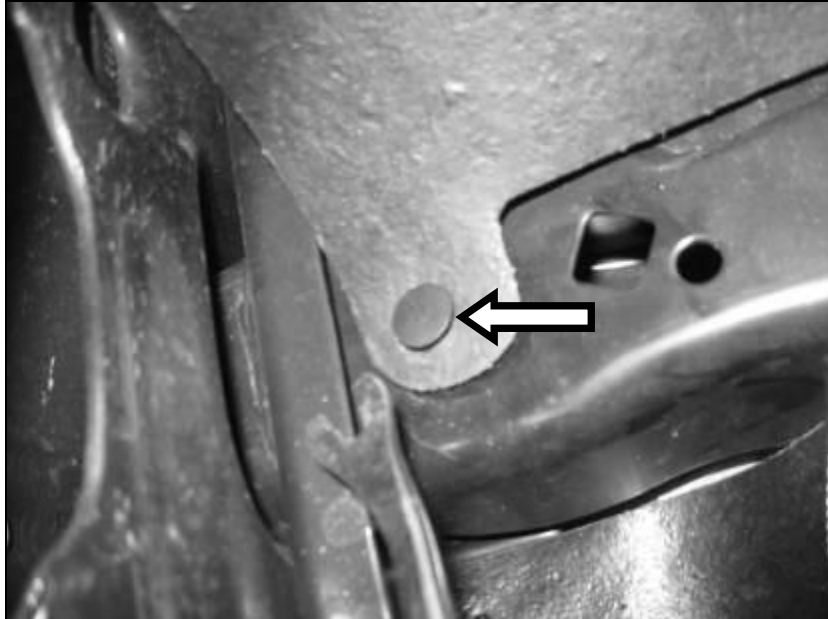

6. With the lower bolt on the passenger side removed, place the LTR Cross brace and pump assembly into position in the vehicle with the pump on the passenger side facing towards the radiator. Re-install the take out bolt (from step 4) into the Lower LTR Mounting bracket. Torque to 25 Nm.

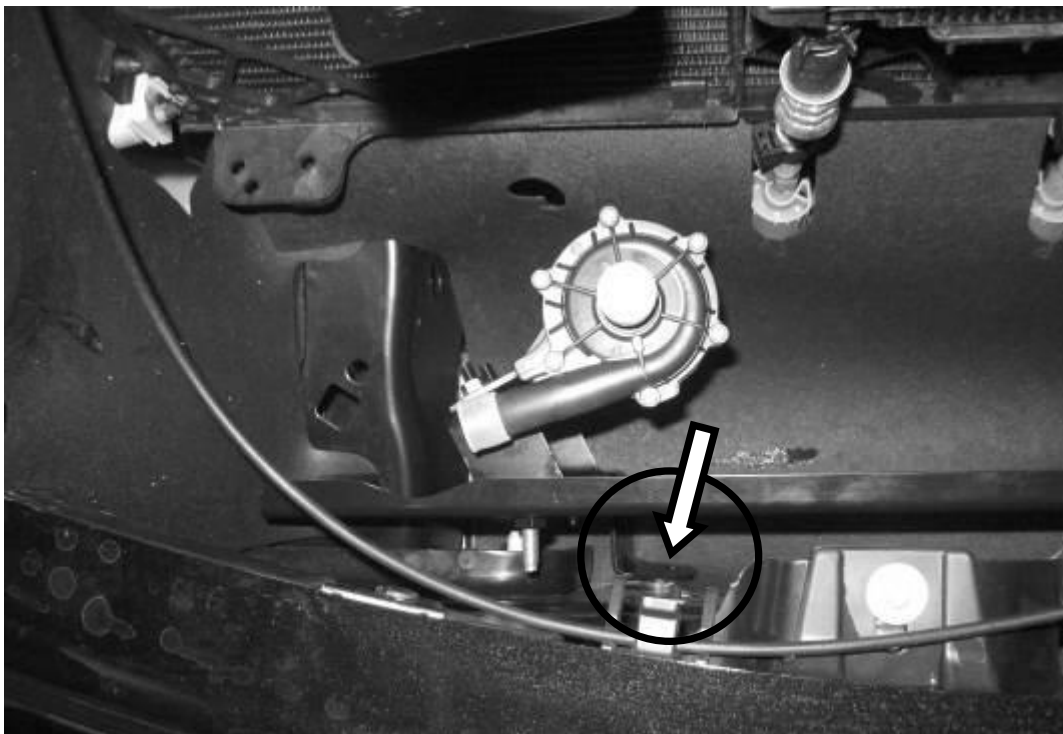



**PREMIUM FUEL REQUIRED – NOT E85 COMPATIBLE**

7. Position the LTR cross brace over top of the two push pin holes (from step 5) and install the two (2) self threading screws (N802455) found in Hardware Kit D, into the LTR Cross brace on the left and right side of the LTR. Torque to 25 Nm.

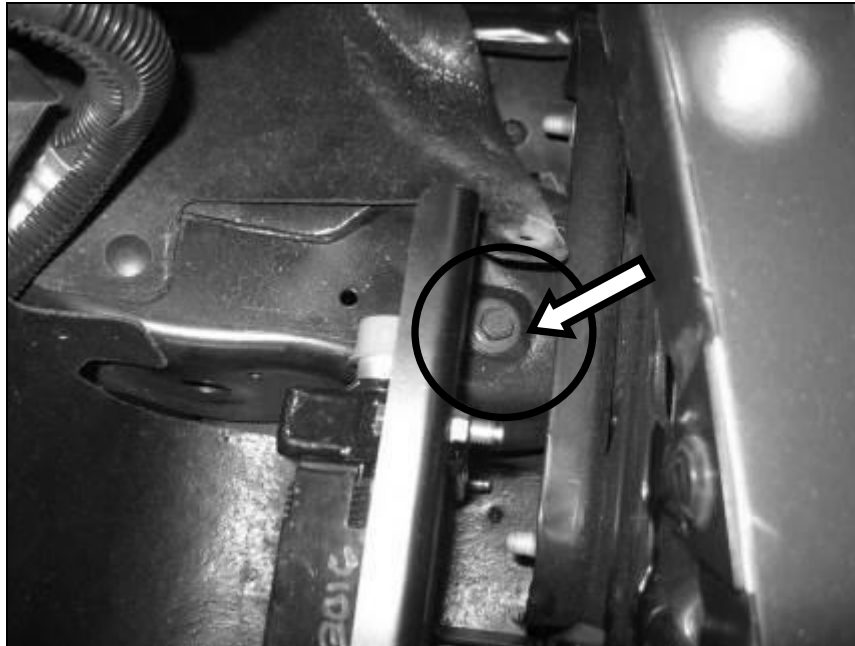

8. Position the lower LTR mounting brackets in behind the LTR Cross Brace such that the lower mounting brackets align with the upper mounting brackets (from step 3). [Pictures shown are removed from vehicle to show clarity.] Install four (4) M8 x 25 (N808920) bolts found in Hardware Kit F (11SC-TVSHKF). Torque to 25 Nm.

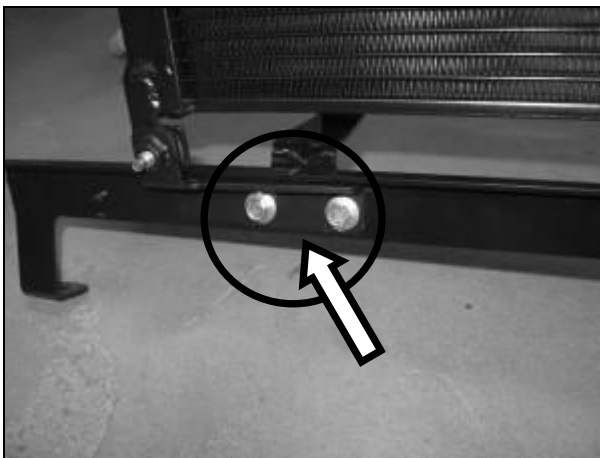





**PREMIUM FUEL REQUIRED – NOT E85 COMPATIBLE**

9. Remove the horn mounting bracket bolt and position the upper mounting bracket in line with the horn mounting bracket. Re-install the bolt and torque to 25 Nm.



10. Position the top mounting bracket on the drivers side against the radiator core support. Mark the hole position and drill an 1/8" pilot hole through the core support. Enlarge the hole by drilling a 1/4" hole. Position the bracket over the hole and install one (1) self tapping M8x27 bolt, found in Hardware Kit F (11SC-TVSHKF). Torque to 25 Nm. Route the hood release cable around the head of the bolt.

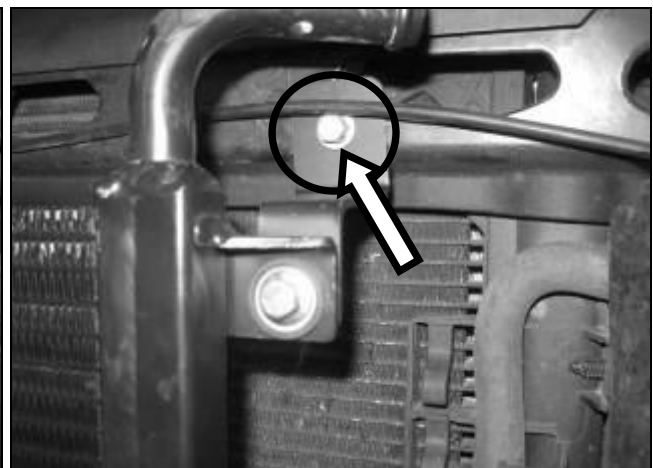
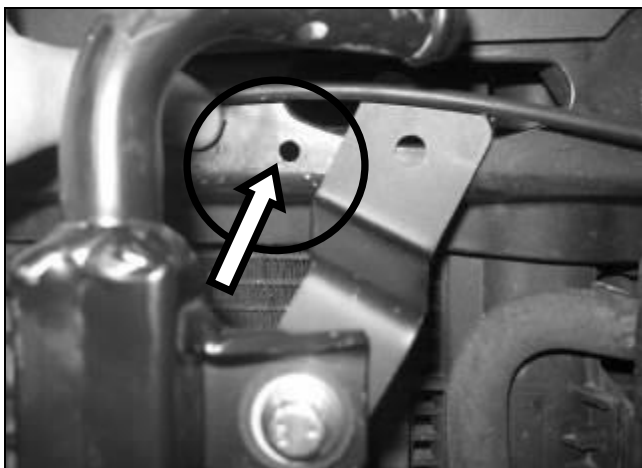



## **PREMIUM FUEL REQUIRED – NOT E85 COMPATIBLE**

### **Intercooler Hose Routing**

1. With the air deflection shield on the passenger side pulled forward, route the Intercooler Pump Inlet Hose (1111-8D029) from the degas bottle outlet port (bottom port) to the open port of the I/C pump by routing the hose along the A/C line and along the frame rail. Route the hose through the opening between the frame rail & the radiator support.



2. Fold the air deflection shield back into the installed position. Using a knife or scissors, enlarge the hole in the air deflection shield where there is already a hole for the A/C line connection. Route the hose and the I/C pump wiring harness connection through this hole. Secure the harness to one of the holes on the radiator using a zip tie.

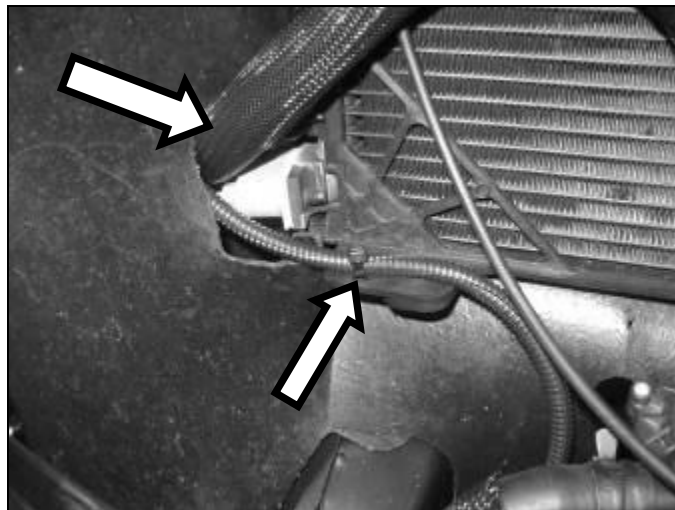



**PREMIUM FUEL REQUIRED – NOT E85 COMPATIBLE**

3. Secure one end of the hose to the bottom of the degas bottle and the opposite end to the inlet on the pump using one (1)  $\frac{3}{4}$ " constant tension clamp (CT19x12-BO) at each end. These can be found in Hardware Kit D (11SC-TVSHKD). Connect the I/C pump harness to the pump.

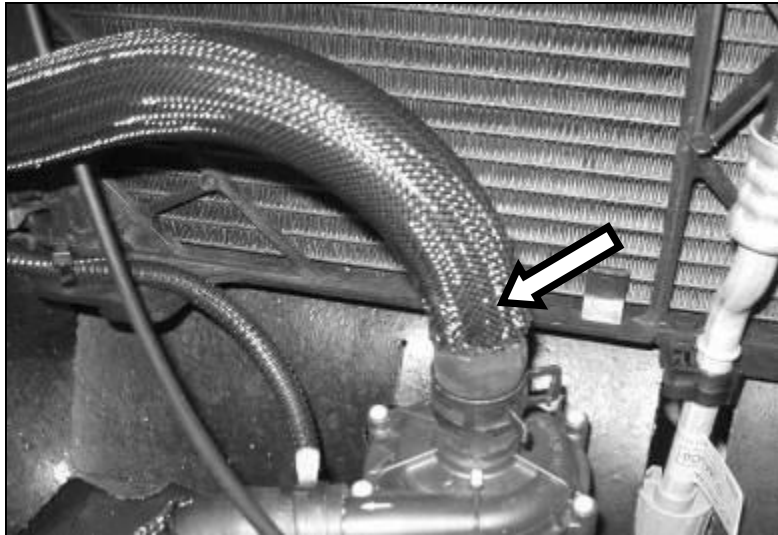

4. Install one (1)  $\frac{3}{4}$ " constant tension clamp (CT19x12-BO) onto either end of the I/C Pump to LTR hose (1113-FFLTR8K236). Install the hose onto the pump outlet and onto the LTR inlet and position the clamps to secure the hose.

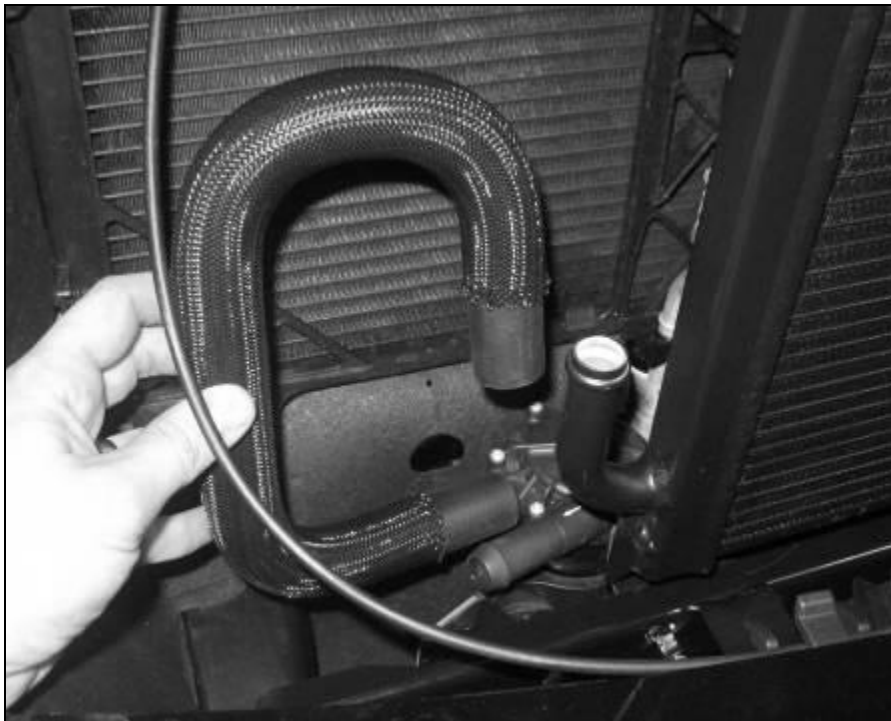



**PREMIUM FUEL REQUIRED – NOT E85 COMPATIBLE**

5. Install one (1)  $\frac{3}{4}$ " constant tension clamp (CT19x12-BO) over both ends of the 1111-8K236 hose. These can be found in Hardware Kit D (11SC-TVSHKD). Connect the short end of the hose to the outlet port of the LTR. Insert the  $\frac{3}{4}$ " x  $\frac{3}{4}$ " hose connector into the long side of the 1111-8K236 hose and make sure the clamps are in the proper position.

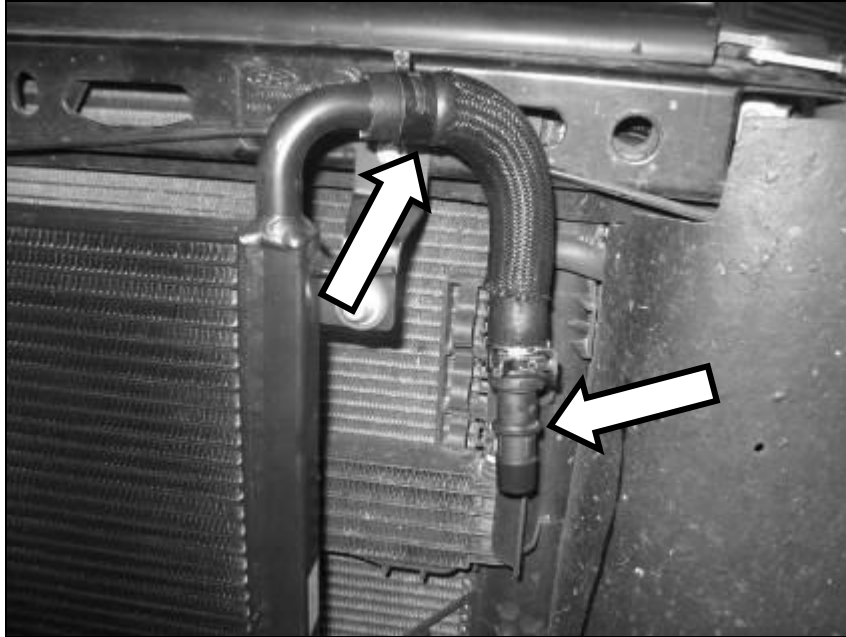

6. Route the LTR Outlet Hose (1111-8D030) through the opening between the frame and radiator on the lower corner of the radiator. Connect the hose to the hose connector and secure using one (1)  $\frac{3}{4}$ " constant tension clamp (CT19x12-BO).

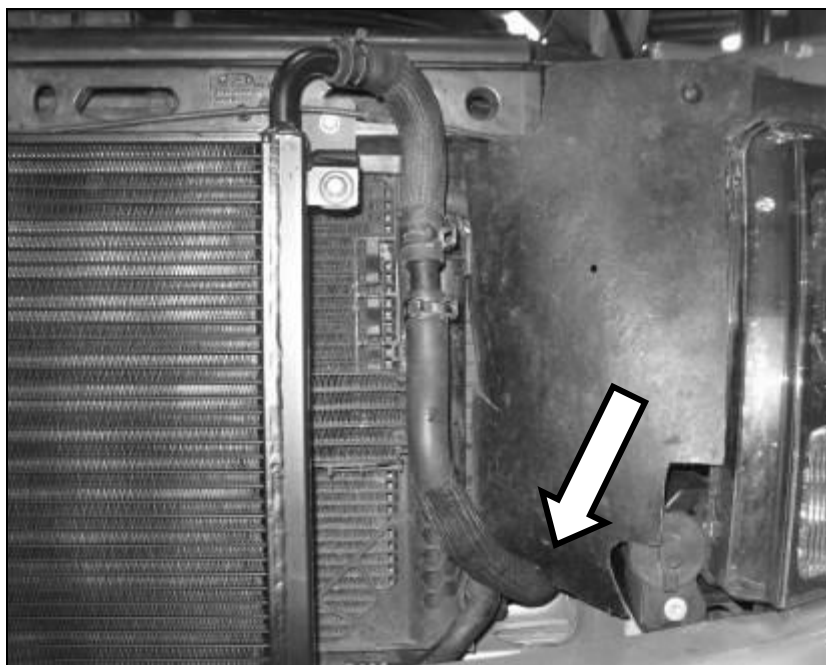



**PREMIUM FUEL REQUIRED – NOT E85 COMPATIBLE**

7. Drill two small 1/8" holes through the plastic retainer holding the transmission oil cooler into position. Install the 3" length of hose convolute around the hose in this area and retain the hose to the bracket using the provided zip ties.

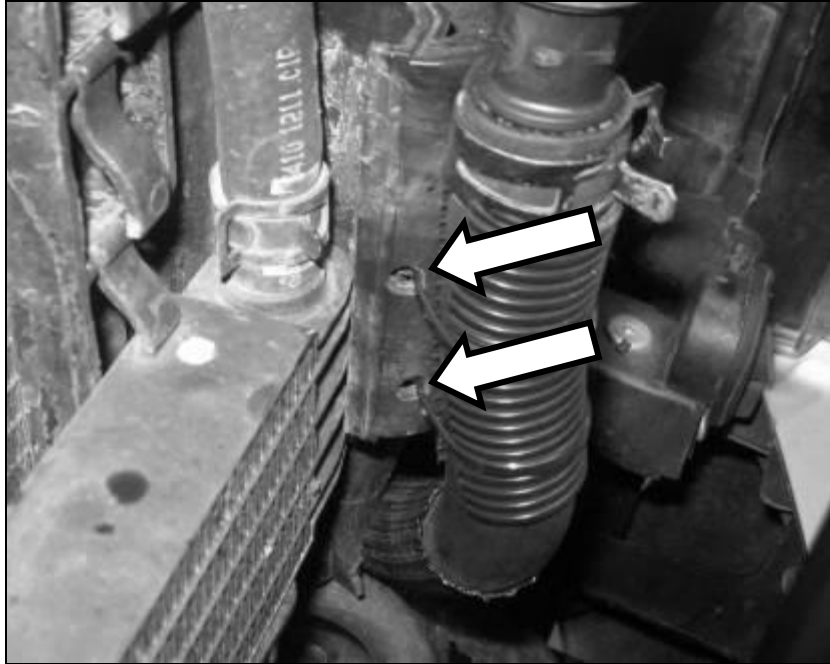

8. The finished hose routing should look like this.

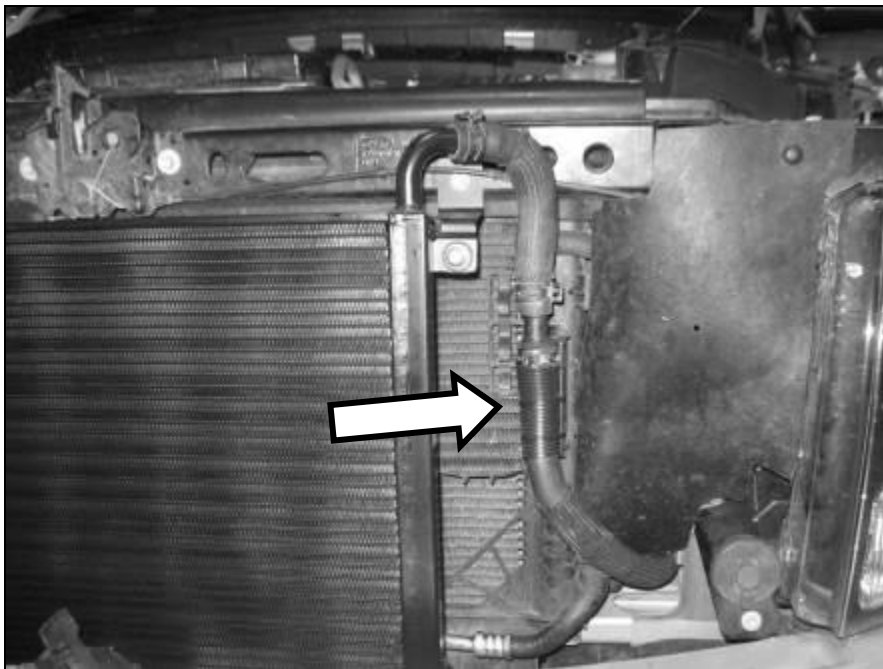



**PREMIUM FUEL REQUIRED – NOT E85 COMPATIBLE**

9. Install the Degas Bottle to CAC hose (1111-8D031) by connecting it to the top port on the degas bottle (facing the cowl) and routing it around the rear of the engine. Secure the hose to the inlet of the degas bottle using (1)  $\frac{3}{4}$ " constant tension clamp (CT19x12-BO). This can be found in Hardware Kit D (11SC-TVSHKD). Retain the hose along the main engine harness across the rear of the engine using zip ties. Route the opposite end of the hose to the front corner of the driver's side cam cover.

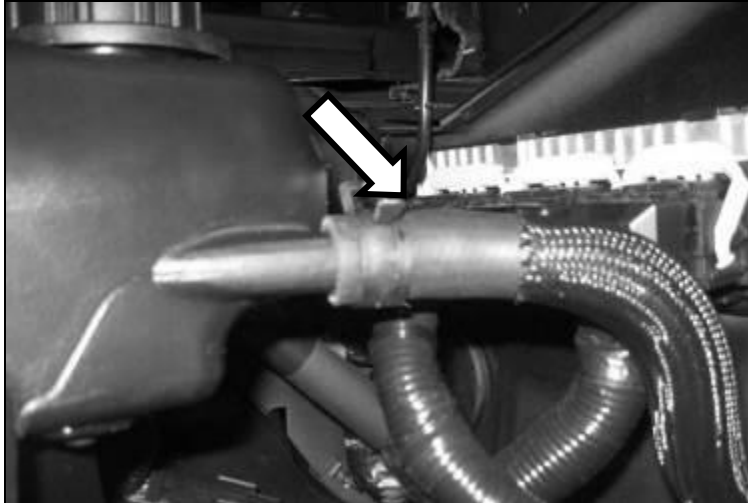

**Note:** Route all intercooler hoses very carefully. It is critical for intercooler performance that these hoses are not kinked once installed into the vehicle.



## **PREMIUM FUEL REQUIRED – NOT E85 COMPATIBLE**

### **FEAD Bracket Installation**

1. Install the new Heater Return Tube (1162-18674) into the engine block. Re-use the factory bolts and torque to 10 Nm.

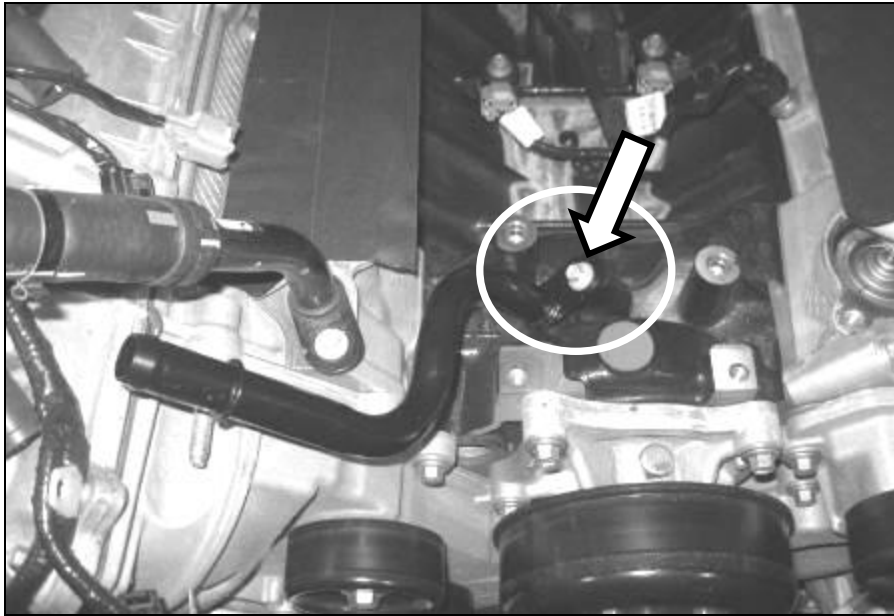

2. Insert the two dowel pins (R07050097) found in Hardware Kit C (1162-TVSHKC) by tapping into position on the two rear holes of the new FEAD bracket (1162-8B653). On late 2013 vehicles, Ford eliminated the dowel holes in the engine block. Install the FEAD bracket without these dowels.

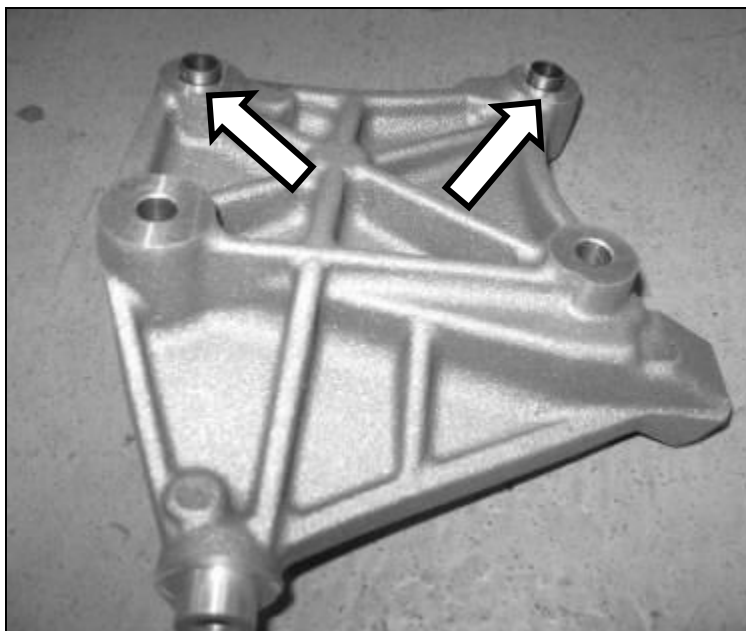



**PREMIUM FUEL REQUIRED – NOT E85 COMPATIBLE**

3. Place the new bracket on top of the four bosses at the front of the engine aligning the dowels up with the counter bored holes in the block, if equipped. Insert the four M8 mounting bolts from Hardware Kit C (1162-TVSHKC) into the bosses as indicated:  
Bolt A - M8 x 40 (qty of 2) : Bolt B - M8 x 55 (qty of 1) : Bolt C - M8 x 75 (qty of 1)  
Torque the bolts to 25 Nm in an X pattern.

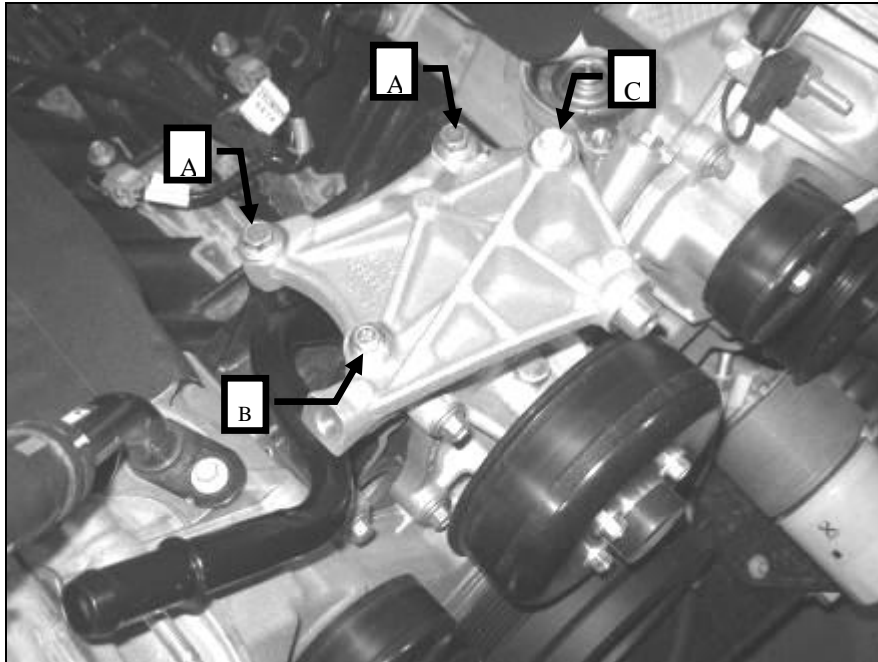

4. Install the idler pulley (900873) onto the post of the FEAD bracket and install the idler pulley mounting bolt (R18020060). These items can be found in Hardware kit C. Torque to 25 Nm.

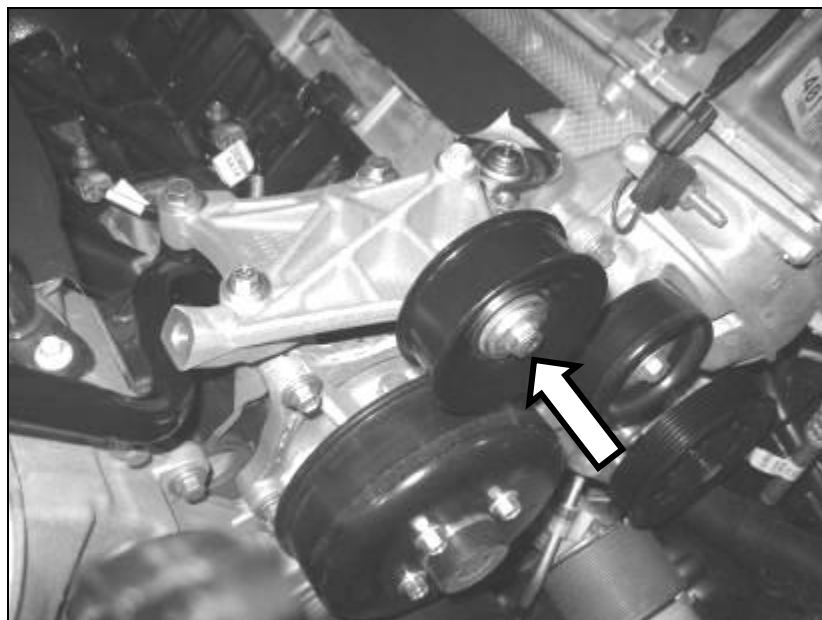





## PREMIUM FUEL REQUIRED – NOT E85 COMPATIBLE

### Fuel Charging and Supercharger Installation

1. Remove the tape from the cylinder heads and clean the cylinder head to intake manifold mating surfaces.
2. Remove the Fuel Charging Assembly (1162-9H487) from its protective packaging and install it on top of the engine. Insert the ten (10) M6 x 1.0 x 74.5 mm bolts (R18020053) found in Hardware Kit B (1162-TVSHKB) into the positions shown and tighten the sequence in two stages. Stage 1; torque bolts to 10 Nm. Stage 2; tighten bolts an additional 45 degrees. With the fuel charging assembly in position, re-route the engine wiring harness at the rear of the intake manifold.

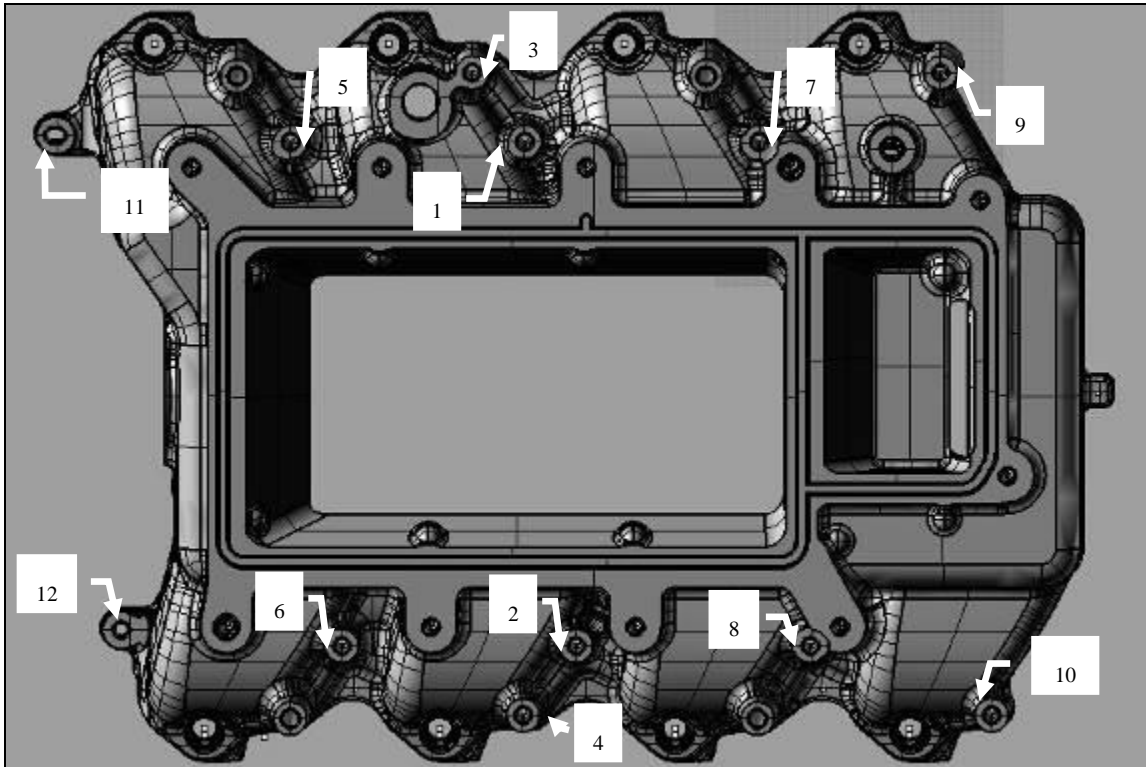

3. Insert two (2) M6 x 1.0 x 32.5 intake mounting bolts found in hardware kit B, into the front corners of the intake (#11 & 12). Torque to 10Nm and then an additional 45 degrees.
4. Carefully remove the supercharger (1162-6F066) from its packaging and place on a workbench or solid flat surface. Remove the protective shipping covers. Install the “ROUSH” badge (R09010347) onto the top machined pad of the supercharger.



**PREMIUM FUEL REQUIRED – NOT E85 COMPATIBLE**

5. Install the 75mm supercharger pulley (1162-6K75) onto the hub of the supercharger using the six (6) M6 x 14 fasteners (N605771) found in Hardware Kit C (1162-TVSHKC). Apply a small amount of blue thread locking compound to the bolts and torque to 10Nm. Note: Orient the s/c pulley such that the head of the bolts sit in the countersunk holes of the pulley.

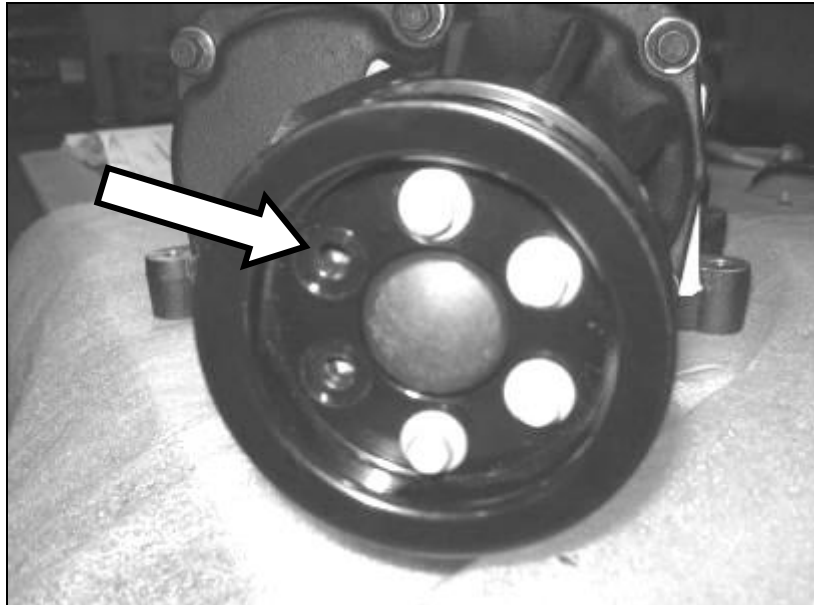

6. Connect the supercharger bypass reference vacuum line (23.5" length of hose R18140001) to the bottom fitting on the supercharger bypass actuator.

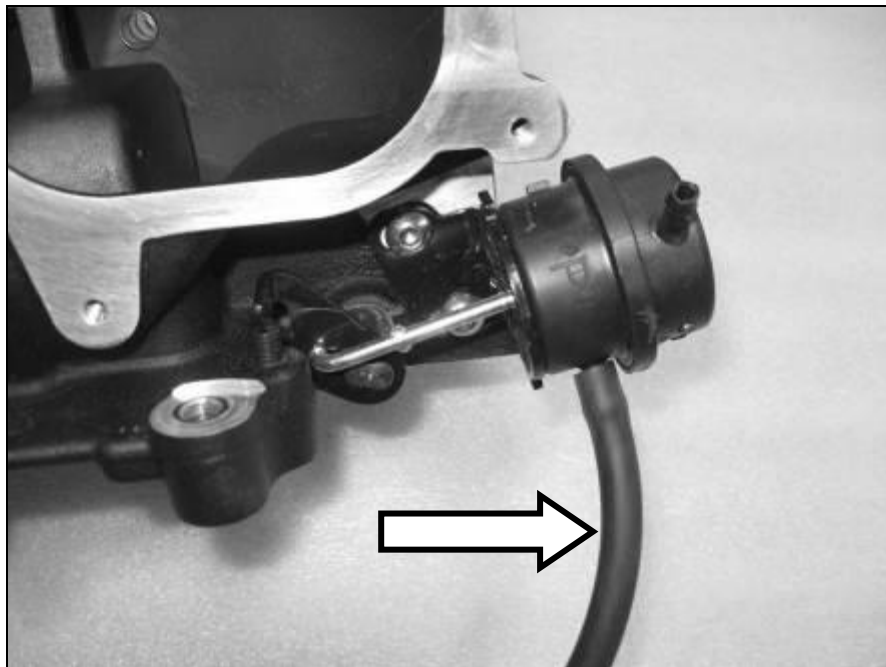



**PREMIUM FUEL REQUIRED – NOT E85 COMPATIBLE**

7. Install the supercharger onto the fuel charging assembly making sure the supercharger is seated firmly on the two intake dowels.



8. Hand start the two (2) rear throttle body spacer M6 x 1.0 x 32.5 mounting bolts (R18020009) found in Hardware Kit B (1162-TVSHKB) into the two rear holes on the supercharger. Put them in about 4-5 threads.

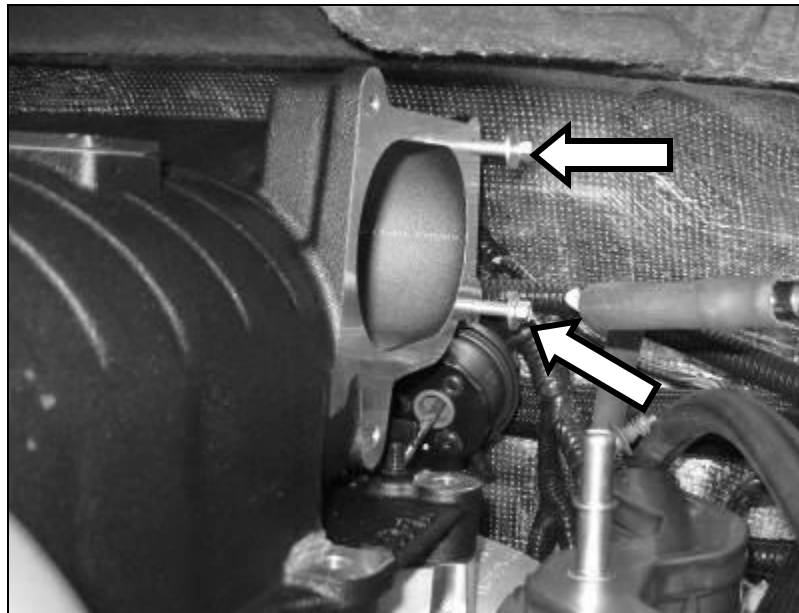



**PREMIUM FUEL REQUIRED – NOT E85 COMPATIBLE**

9. Reach behind the supercharger on the passenger side and connect the bubbler hose from the lower intake to the 90° tube fitting on the rear of the supercharger.

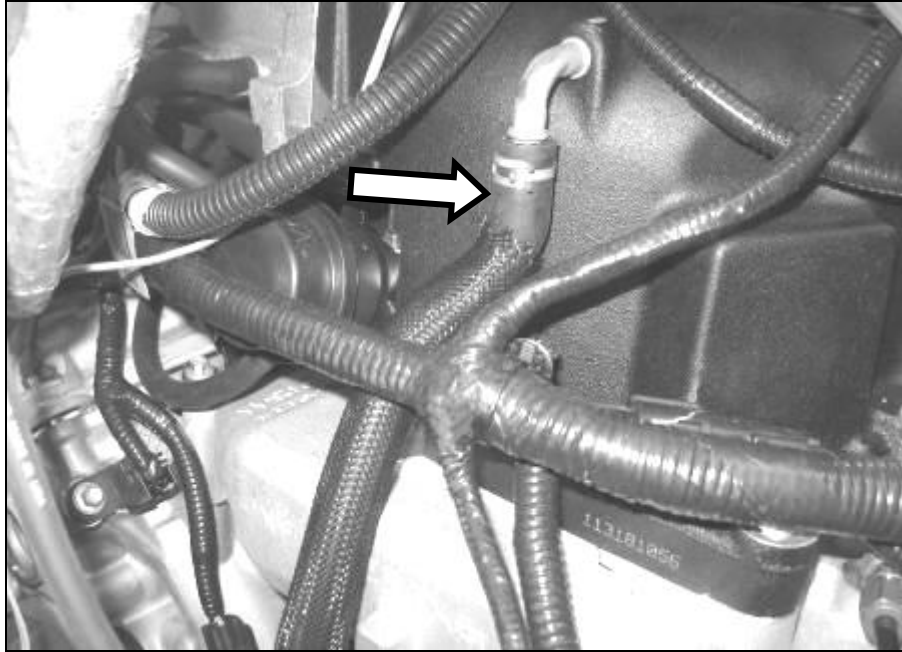

10. Place the rail assembly onto the fuel charging assembly. Make sure each injector is properly seated into the intake manifold. Install the factory fuel rail mounting bolts and tighten the bolts in the pattern shown. Torque to 10 Nm.

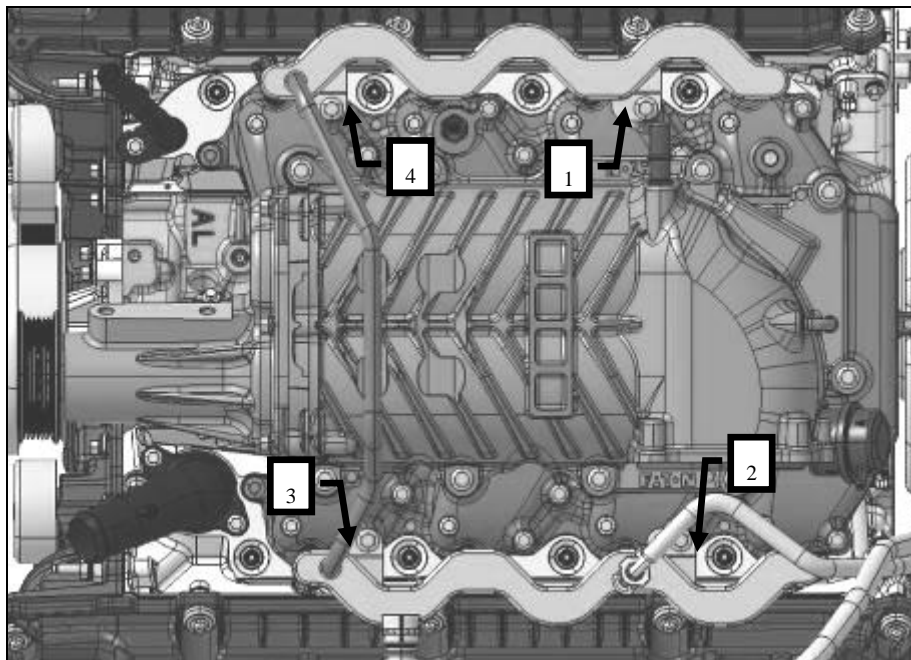



**PREMIUM FUEL REQUIRED – NOT E85 COMPATIBLE**

11. Connect the ACT wire harness (previously wired into the vehicle) to the ACT Sensor on the passenger side of the intake manifold. Route the wires along the main engine harness and retain with zip ties.

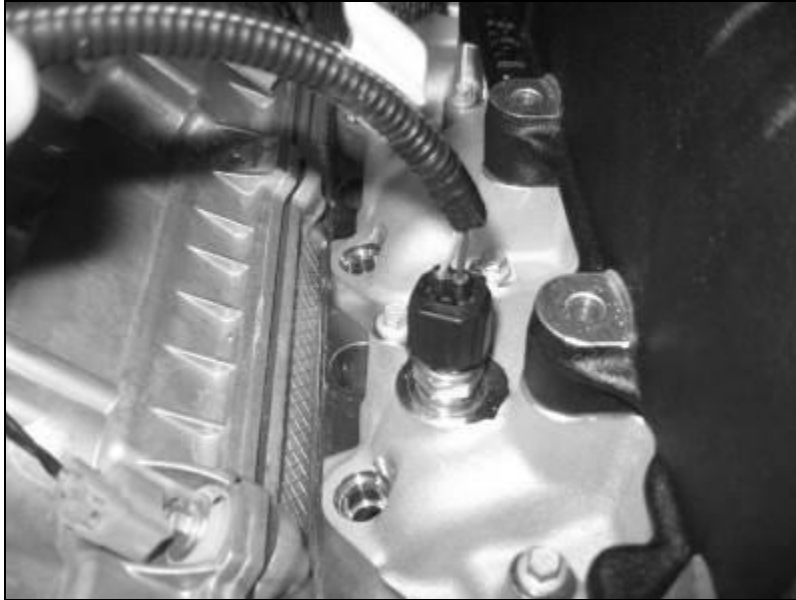

Note: Fuel Rail removed for clarity. Route harness overtop of fuel rail.



**PREMIUM FUEL REQUIRED – NOT E85 COMPATIBLE**

12. Position one (1) Coil on Plug Support bracket (1162-12A359) on either side of the supercharger mounting bosses. Insert eight (8) of the supercharger mounting bolts (W500112) through the coil on plug support brackets on either side. Insert the remaining two (2) bolts in the rear supercharger mounting holes, accessible from the passenger side. These can be found in Hardware Kit B (1162-TVSHKB).





**PREMIUM FUEL REQUIRED – NOT E85 COMPATIBLE**

13. Position the brackets on the slots, towards the front of the engine as far as possible to position the coil on plugs correctly. Torque these bolts to 25 Nm in the sequence shown.

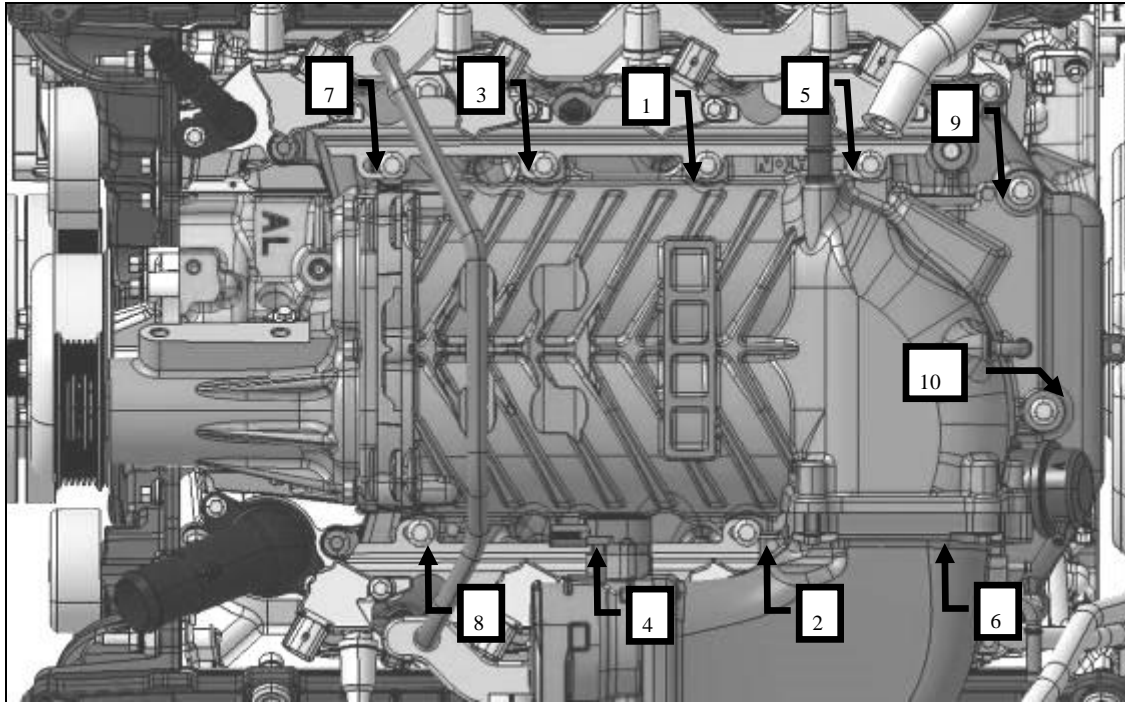

14. Install the four (4) RH side coil packs. Re-use the factory bolts and torque to 10 Nm.



**PREMIUM FUEL REQUIRED – NOT E85 COMPATIBLE**



15. If your vehicle is a 2012-2013 model year, you can now install the radio capacitor underneath the bolt for the forward most coil pack. Route the wires behind the fuel rail and underneath the heater hoses. Torque the bolt to 10 Nm.

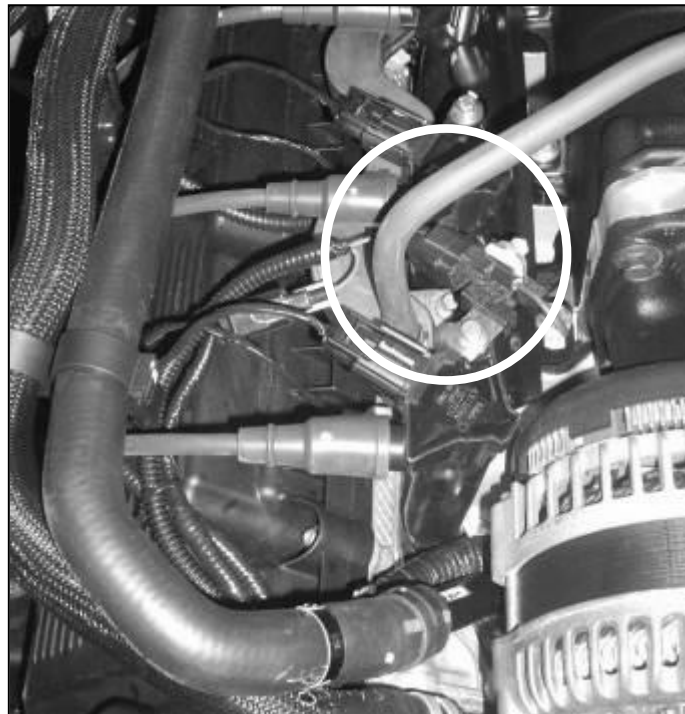

16. Install the four (4) LH side coil packs. Re-use the factory bolts and torque to 10 Nm.





**PREMIUM FUEL REQUIRED – NOT E85 COMPATIBLE**



17. Connect the eight (8) fuel injector electrical connectors.
18. Connect the eight (8) coil pack electrical connectors and the eight (8) coil wires.
19. Connect the fuel supply line to the fuel rail and lock the connector into position.





**PREMIUM FUEL REQUIRED – NOT E85 COMPATIBLE**

20. Carefully slide the throttle body spacer assembly into position on the supercharger. Make sure there is enough of a gap between the washers on the head of the bolt for the throttle body spacer to fit between.

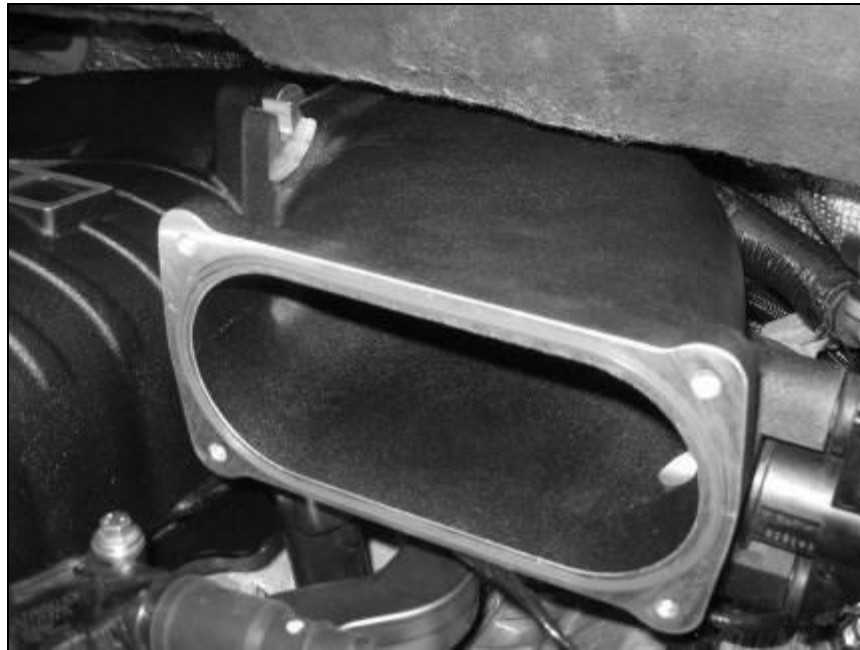

21. Install the forward two (2) throttle body spacer bolts into the supercharger (R18020009).

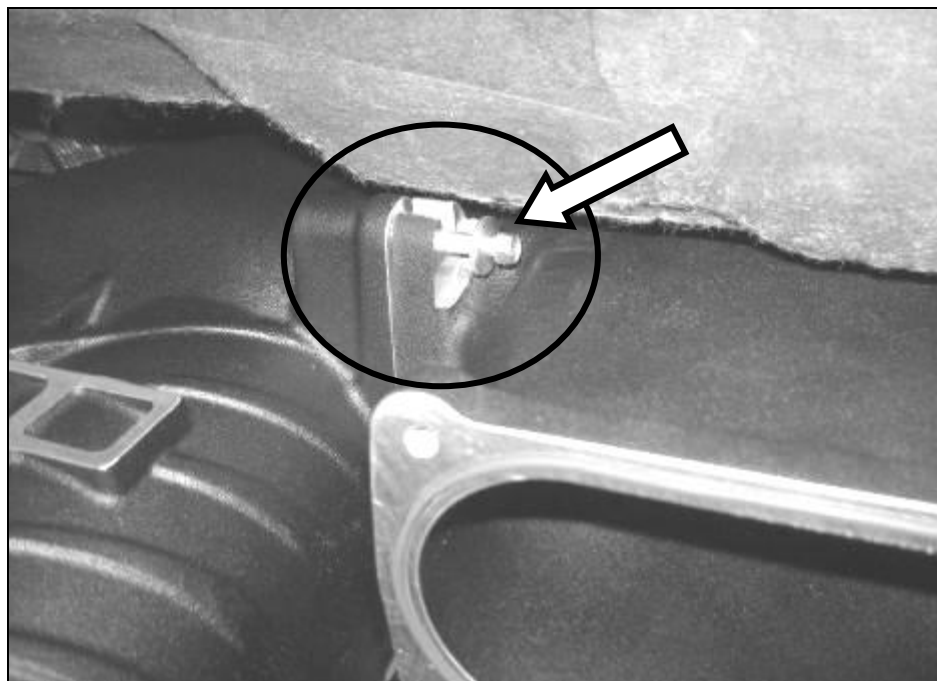

22. Torque the four (4) throttle body spacer to supercharger bolts to 10 Nm. Note: If more tool/hand access is required, remove the VMV Valve from the T/B Spacer for clearance.



**PREMIUM FUEL REQUIRED – NOT E85 COMPATIBLE**

23. From the passenger side, reach behind the supercharger and connect the boost bypass hose from the throttle body spacer to the top port of the supercharger bypass actuator.



24. Connect the short hose to the check valve on the brake booster and secure with the clamp to the check valve.

25. Connect the new Evaporative Emission Canister Purge Valve electrical connector.

26. Connect the new Evaporative Emission Canister Purge Valve hose quick connect fitting to the relocated Purge Valve on the Throttle Body Spacer.

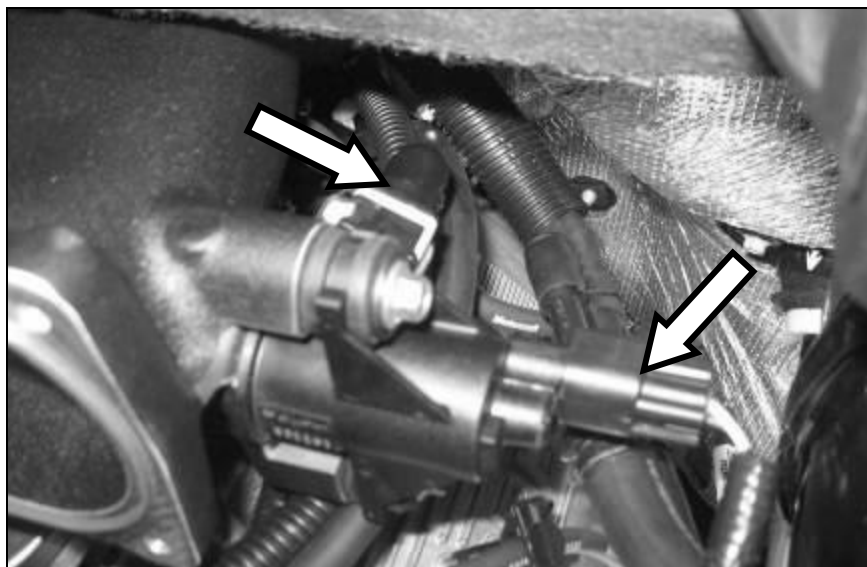



**PREMIUM FUEL REQUIRED – NOT E85 COMPATIBLE**

27. Install the dual bore throttle body (R07060150) onto the throttle body spacer using four (4) M6 x 1.0 x 32.5 bolts (R18020009) found in Hardware Kit B (1162-TVSHKB). Torque to 10 Nm.

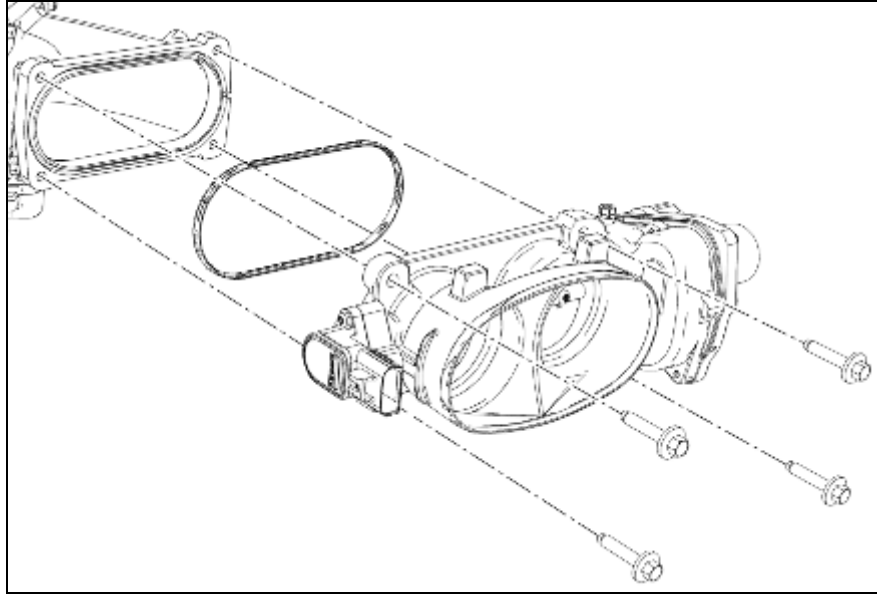

28. Connect the TPS and ETC Throttle Body electrical connectors.

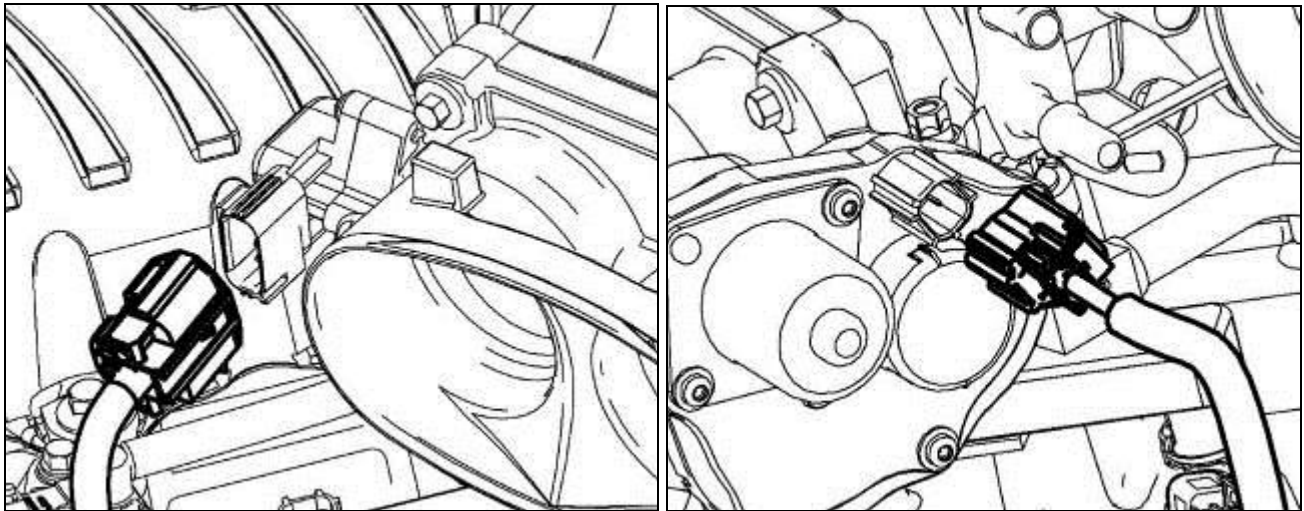



**PREMIUM FUEL REQUIRED – NOT E85 COMPATIBLE**

29. Connect the Intercooler LTR Outlet hose (1111-8D030) to the lower turret on the intake manifold. Secure the hose using one (1)  $\frac{3}{4}$ " constant tension clamp from Hardware Kit D. Connect the Degas Bottle Inlet Hose (1111-8D031) to the upper intercooler turret on the intake manifold. Secure using one (1)  $\frac{3}{4}$ " constant tension clamp from Hardware Kit D.

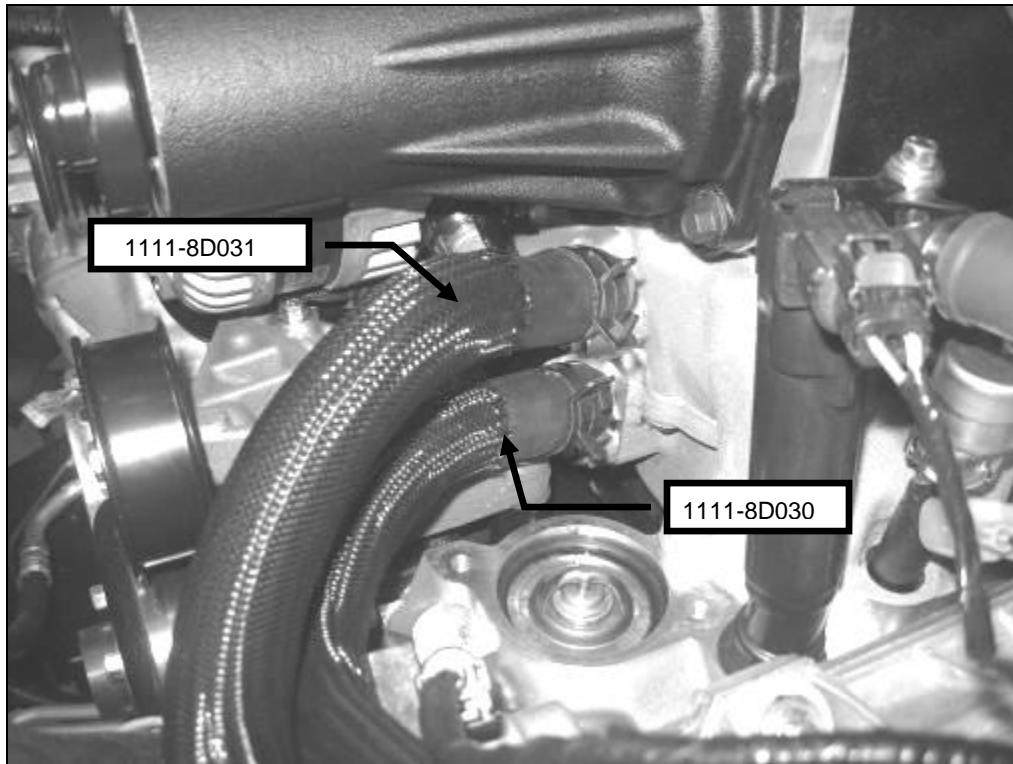



**PREMIUM FUEL REQUIRED – NOT E85 COMPATIBLE**

30. Remove the factory idler pulley to the left of the water pump pulley.



31. Install the new flanged idler (R07020049) provided using the take out fastener.  
Torque to 25Nm.





**PREMIUM FUEL REQUIRED – NOT E85 COMPATIBLE**

32. Re-install the thermostat outlet neck. Torque to 10 Nm.



33. Remove the plastic cover on the end of the B+ cable.





**PREMIUM FUEL REQUIRED – NOT E85 COMPATIBLE**

34. Undo the three (3) Christmas tree push pins that retain the B+ Cable to the top of the radiator support and fan shroud and remove these from the harness.



35. Connect the B+ cable to the Alternator. Torque to 17 Nm.

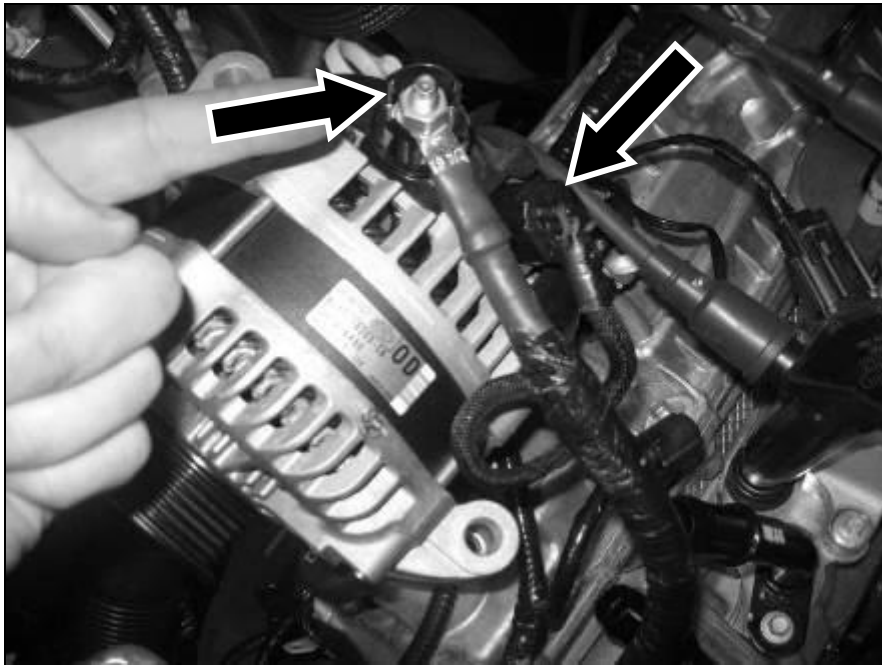

36. Connect the Alternator electrical connector. Make sure to route the alternator wires underneath the alternator between the heater return tube and the intake manifold.





**PREMIUM FUEL REQUIRED – NOT E85 COMPATIBLE**

37. Roll the alternator into position so the single mounting bolt lines up with the FEAD bracket and the two mounting bolts line up with the supercharger snout. Install three (3) M10 x 75 bolts found in Hardware Kit C (1162-TVSHKC). Note: Run an M10x1.5 Die over the threads of these three bolts to make sure they are free from burrs / nicks. Torque to 47 Nm.

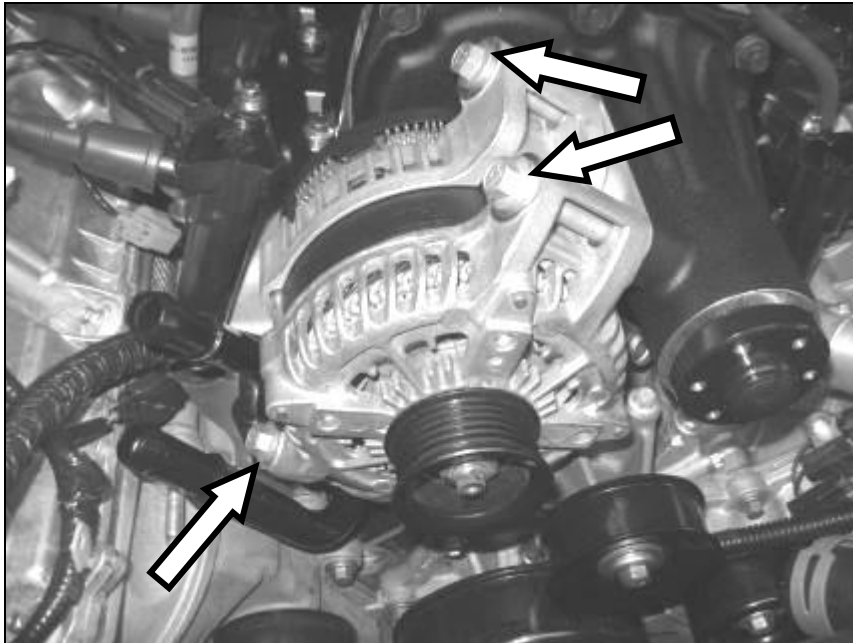

38. Re-connect the PCV Purge to the PCV Valve on the passenger side cam cover and the port on the supercharger. Rotation of the fittings in either end of the line to get the proper orientation may be required. Route the PCV line underneath the heater hoses.

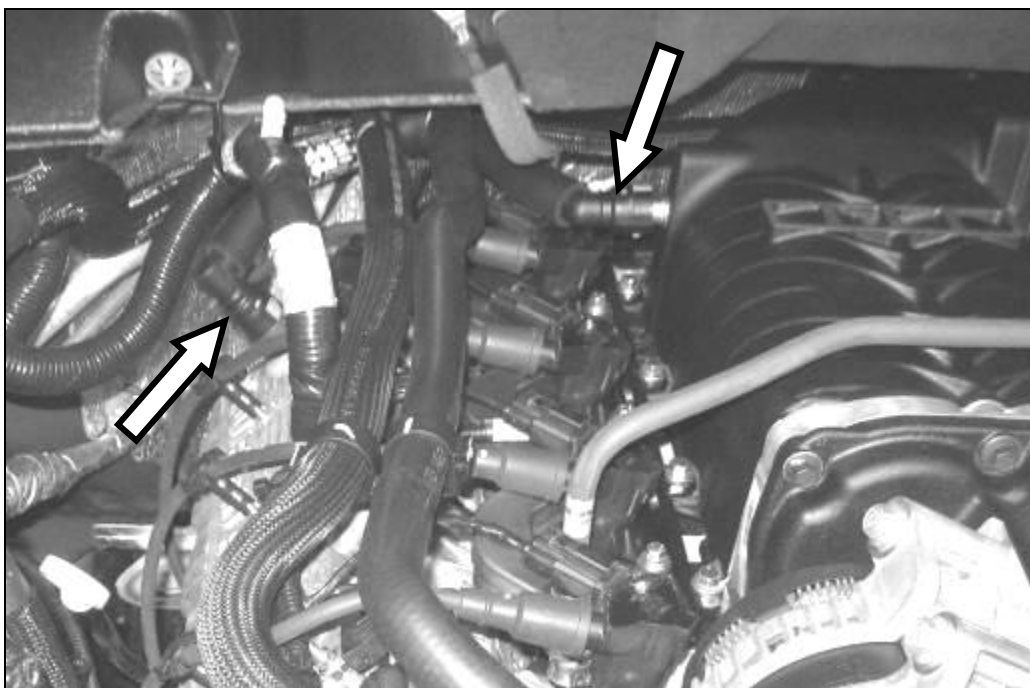



**PREMIUM FUEL REQUIRED – NOT E85 COMPATIBLE**

39. Re-connect the heater hoses to the tubes at the front of the engine. Secure into position with the clamps.

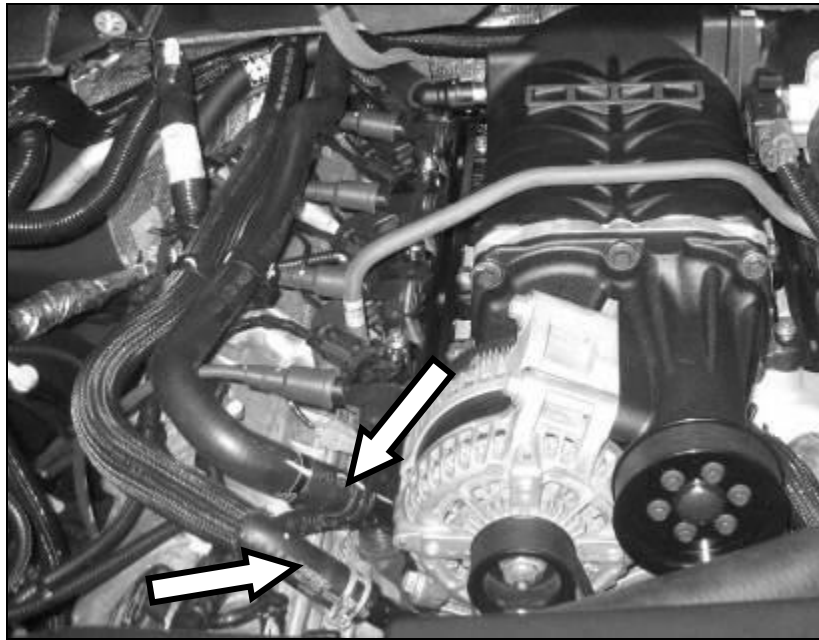

40. Using a 1/2" breaker bar, rotate the tensioner clockwise and install the new FEAD belt (6K3200-8620) as per the routing shown below.

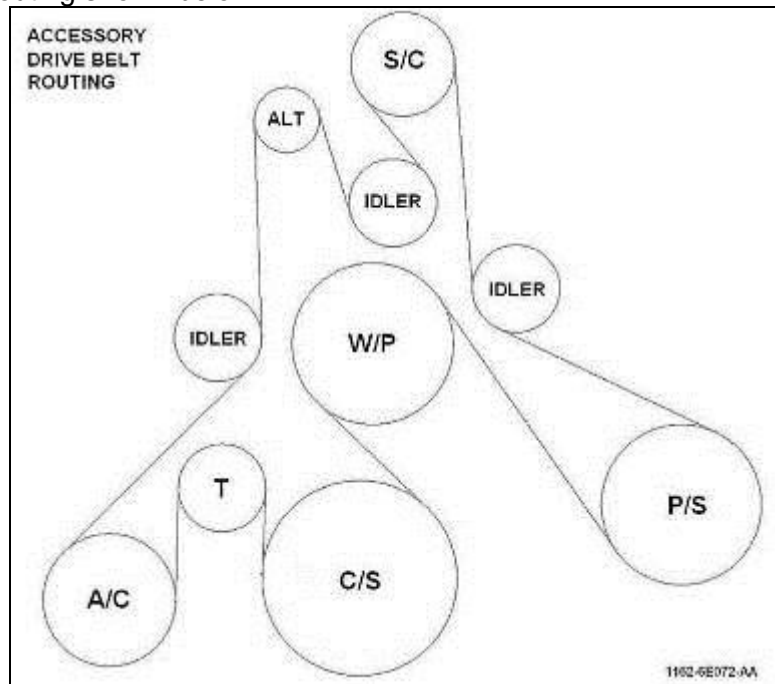



**PREMIUM FUEL REQUIRED – NOT E85 COMPATIBLE**

41. Locate the RF Capacitor at the driver side of the vehicle, just under the heater hoses. Disconnect the RF Capacitor connector. Using a 15 mm socket, remove the engine front cover nut and discard. Remove the RF Capacitor and save for reuse. Using an 18 mm socket, remove and discard the remaining stud.

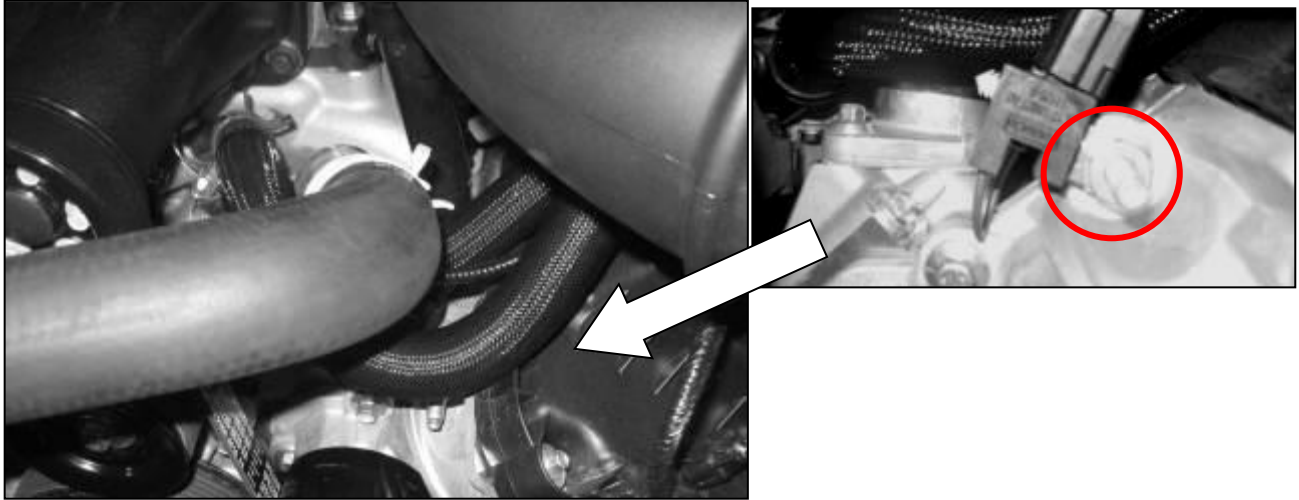

42. Using a 10 mm socket, remove and discard the (3) front cover bolts shown below.

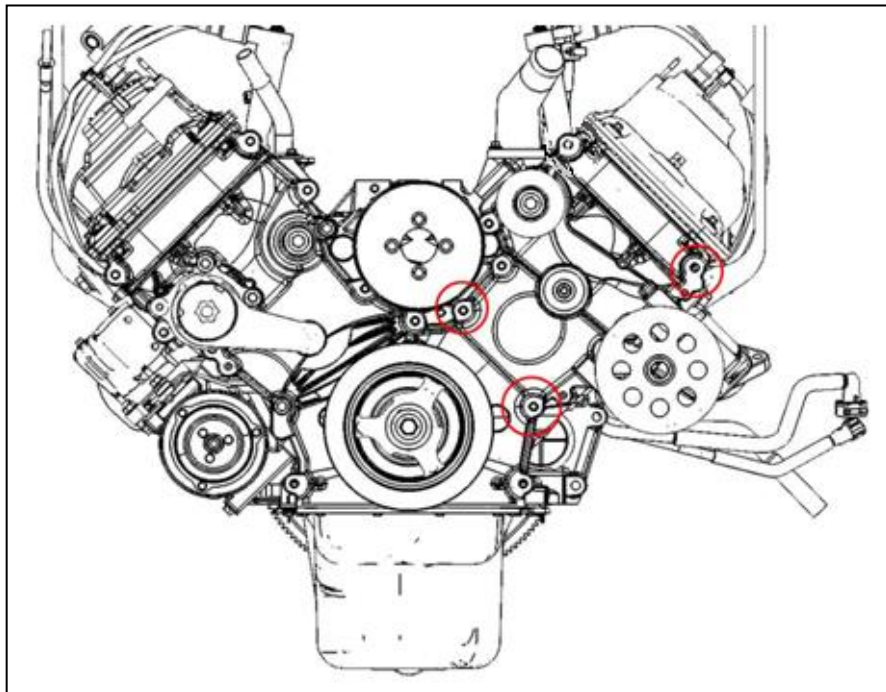



**PREMIUM FUEL REQUIRED – NOT E85 COMPATIBLE**

43. Position (1) supplied spacer (PN: 1162-3N856) behind the plate at the location of the highest bolt hole (just above the ROUSH lettering). Slip (1) supplied bolt (PN: M8X125X110H-NF) through (1) supplied washer (PN: WM8X20X2) and slide it into the plate bolt hole, through the positioned spacer. Position the RF Capacitor between the spacer and front cover so the opening of the connector is facing the driver's side of the vehicle. Loosely thread the bolt into the front cover/engine block.

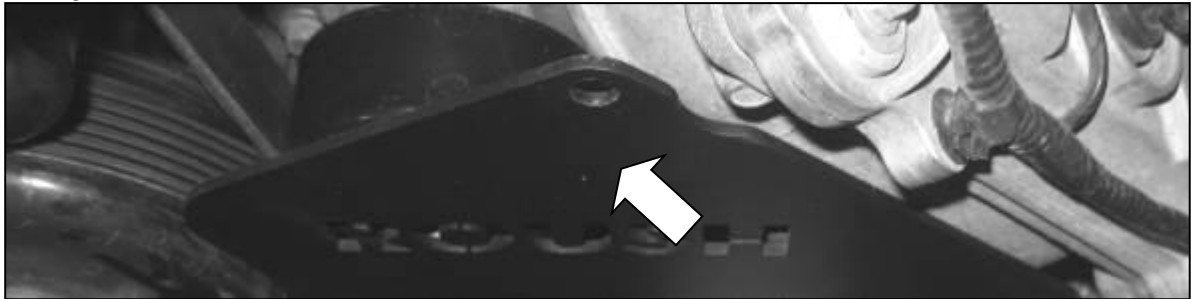

44. Position (1) supplied spacer (PN: 1162-3N856) behind the plate at the bolt hole location nearest to the water pump pulley. Slip (1) supplied bolt (PN: M8X125X110H-NF) through (1) supplied washer (PN: WM8X20X2) and slide it through the plate bolt hole and the positioned spacer. Loosely thread the bolt into the front cover/engine block.





## **PREMIUM FUEL REQUIRED – NOT E85 COMPATIBLE**

45. Position (1) supplied spacer (PN: 1162-3N856) behind the plate at the lowest bolt hole location. Slip (1) supplied bolt (PN: M8X125X110H-NF) through (1) supplied washer (PN: WM8X20X2) and slide it through the plate bolt hole and the positioned spacer. Loosely thread the bolt into the front cover/engine block. (Note: Image below is from underside of vehicle).

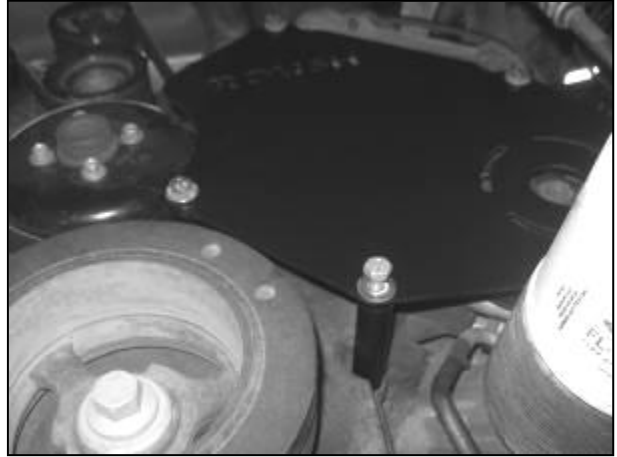

46. Check the spacing between the plate and power steering pump pulley and water pump pulley (refer to step 1 of assembly). Using a 13 mm socket, tighten the top bolt above the ROUSH, securing the RF Capacitor.





## PREMIUM FUEL REQUIRED – NOT E85 COMPATIBLE

47. Next, tighten the lower FEAD plate bolt, then the bolt nearest the passenger side of the vehicle, and lastly the bolt nearest the driver's side of the vehicle. Torque the fasteners to 10 Nm (89 lb-in) in the same sequence. Then repeat the process to 20 Nm (177 lb-in). Finally tighten the fasteners another 45 degrees. (Note: Image below is from underside of vehicle).

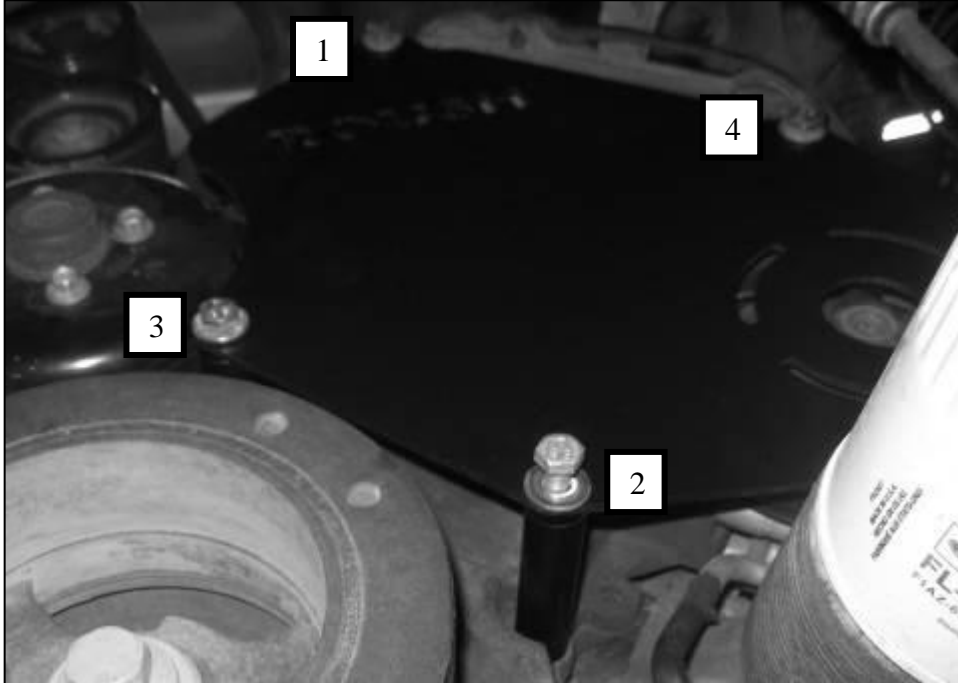

48. Locate the RF Capacitor connector that was disconnected in the disassembly section. Plug the connector into the RF Capacitor.





**PREMIUM FUEL REQUIRED – NOT E85 COMPATIBLE**

49. Reinstall the upper radiator hose and connect to both the engine and radiator. Re-clip to the fan shroud using the factory retention clip.





**PREMIUM FUEL REQUIRED – NOT E85 COMPATIBLE**

**Air Induction System**

1. Install the new ROUSH open air filter element (997-466) onto the MAF Tube (11SC-12B579) and tighten the clamp.



2. Install the two (2) J-clips (W520823) provided in Hardware Kit A (11SC-TVSHKA) onto the airbox lid as shown.

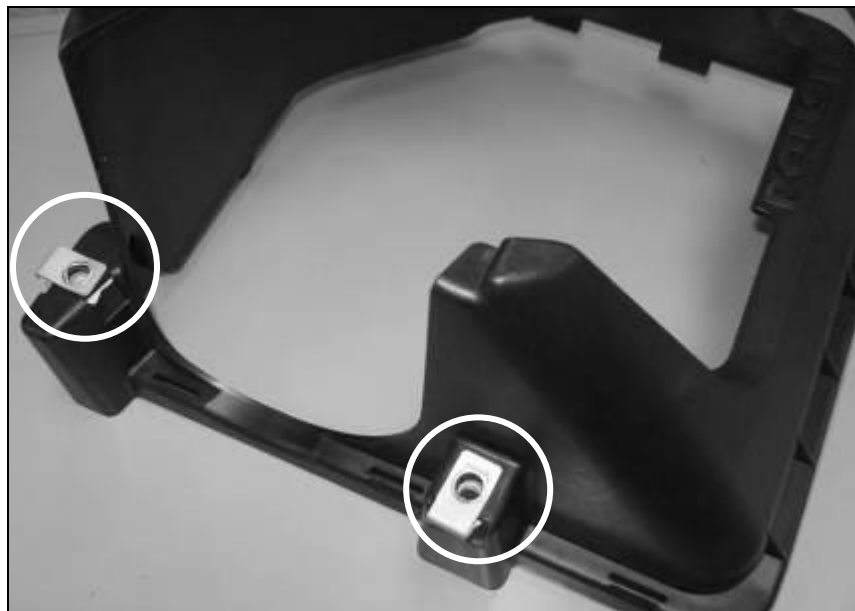





**PREMIUM FUEL REQUIRED – NOT E85 COMPATIBLE**

3. Slide the MAF tube and filter assembly through the bottom opening and into the new ROUSH air box lid (1111-9A600).



4. Install the EPDM close out seal (1111-9645) around the MAF Tube and clip into the top edges of the upper air box tray.





**PREMIUM FUEL REQUIRED – NOT E85 COMPATIBLE**

5. Secure the MAF tube to the air box lid using the two (2) M8x25 bolts (W500224) supplied in Hardware Kit A (11SC-TVSHKA). Torque to 20 Nm.



6. Place the new ROUSH air box lid assembly (air box lid / filter / MAF tube) into the vehicle. Snap the three lower air box clips into position securing the upper lid assembly.





**PREMIUM FUEL REQUIRED – NOT E85 COMPATIBLE**

7. Install the small vacuum fitting (P217N) found in Hardware Kit A into the middle port on the clean air tube and connect the Boost Bypass hose to this fitting.
8. Install the larger vacuum fitting (P2233A) found in Hardware Kit A into the forward port on the clean air tube and connect the Brake Booster Aspirator hose to the this fitting.

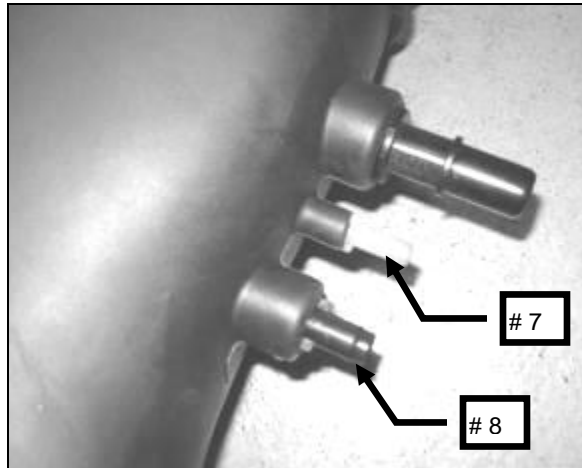

9. Install the new Clean Air Tube Assembly (11SC-9B659) into position between the throttle body and the MAF tube. Tighten the clamps on either end. Connect the brake aspirator line to the larger 3/8" port on the clean air tube. Connect the supercharger bypass hose to the smaller 1/4" port on the clean air tube.





**PREMIUM FUEL REQUIRED – NOT E85 COMPATIBLE**

10. Re-connect the PCV Fresh Air Inlet line to the cam cover and route to the quick connect fitting on the clean air tube. You may need to rotate the fittings inside the tube to get proper orientation of the line once installed.



11. Re-connect the MAF Sensor electrical connector. Be sure to push the red lock into position once the connection has been made.





## **PREMIUM FUEL REQUIRED – NOT E85 COMPATIBLE**

### **Final Assembly**

1. Re-install the passenger side headlamp assembly, reversing the order of removal.
2. Fill the engine cooling system (using a proper coolant mixture) to the marked level on the radiator degas bottle. Make sure the radiator petcock is closed tightly.
3. Using the same coolant mixture, fill the intercooler system through the degas bottle. The coolant should be approximately one inch below the top of the cap. Install the degas bottle cap (9C3Z-8101) and tighten when full.

**Important: Both coolant systems can trap a large amount of air. It is very important to verify that the air is purged and that coolant is flowing properly through both systems. Roush recommends vacuum filling both systems to properly evacuate the trapped air.**

4. Inspect all under hood wiring harnesses for potential interference issues. Use zip ties to safely position the harness away from any areas of concern.
5. If the PCM was removed and shipped to ROUSH for a ROUSH performed flash, reinstall it once the PCM is returned from ROUSH. If you are equipped with a SAE J2534 pass through device, refer to the PCM Flashing section when installation is complete. **DO NOT ATTEMPT TO REINSTALL THE PCM AND START THE VEHICLE IF THE PCM IS NOT EQUIPPED WITH A ROUSH CALIBRATION. OPERATING THE ENGINE WITHOUT THE RECALIBRATED PCM WILL RESULT IN ENGINE DAMAGE OR FAILURE AND WILL VOID THE WARRANTY.**
6. Re-install the battery tray and the battery into the vehicle. Make the terminal connections by connecting the positive (+) cable first then connecting the negative (-) cable.
7. Reconnect the Fuel Pump Control Module electrical connector located above the spare tire on the frame.
8. Place the PCM warning sticker above the PCM on the cowl of the vehicle.

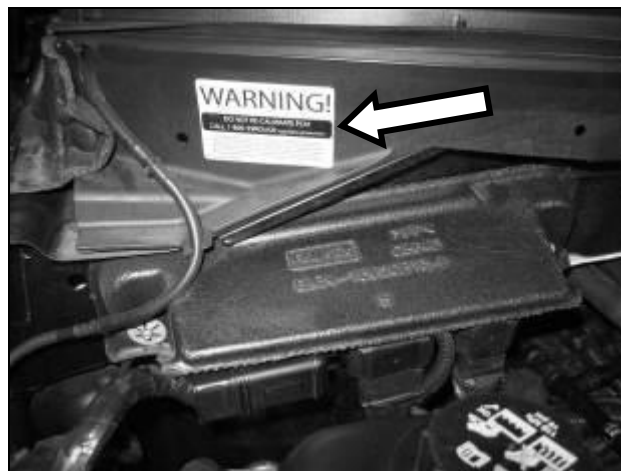



**PREMIUM FUEL REQUIRED – NOT E85 COMPATIBLE**

9. The Belt Routing Diagram (1162-6E072) is to be placed on the underside of the hood, on the passenger side, beside the factory Vehicle Emission Control Information decal.

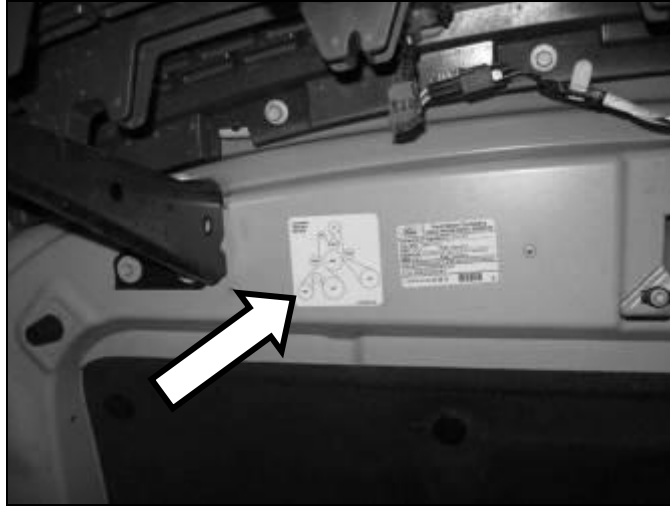

10. Place the Fuel Door Decal (R0711005) on the backside of the fuel door. With the supercharger system installed, the vehicle is no longer E85 Compatible. If your vehicle has a Flex-Fuel badge, it is recommended that this also be removed at this time.

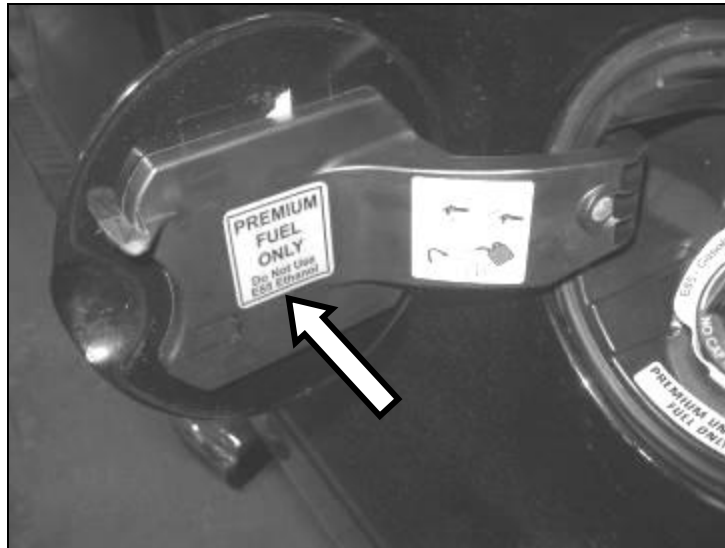



## PREMIUM FUEL REQUIRED – NOT E85 COMPATIBLE

11. Place the Premium Unleaded Fuel Only Decal (13109A095) inside the fuel door, below the fuel filler neck.

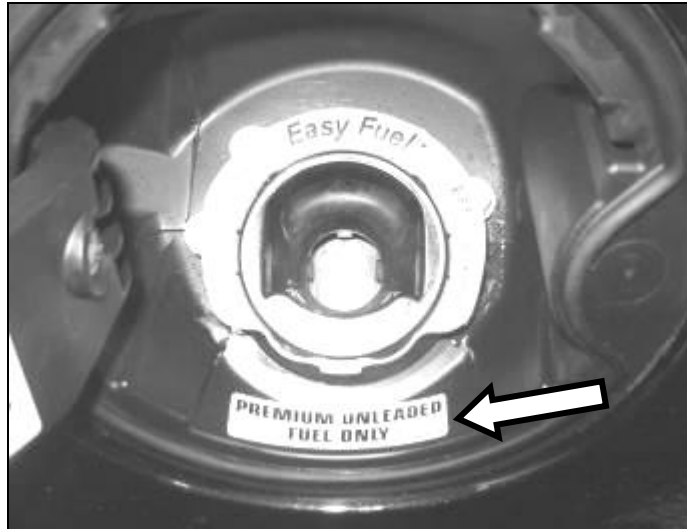

12. Place the “Premium Fuel” clear decal with white lettering on the instrument cluster bezel, on the flat area below the small center gauges as shown.

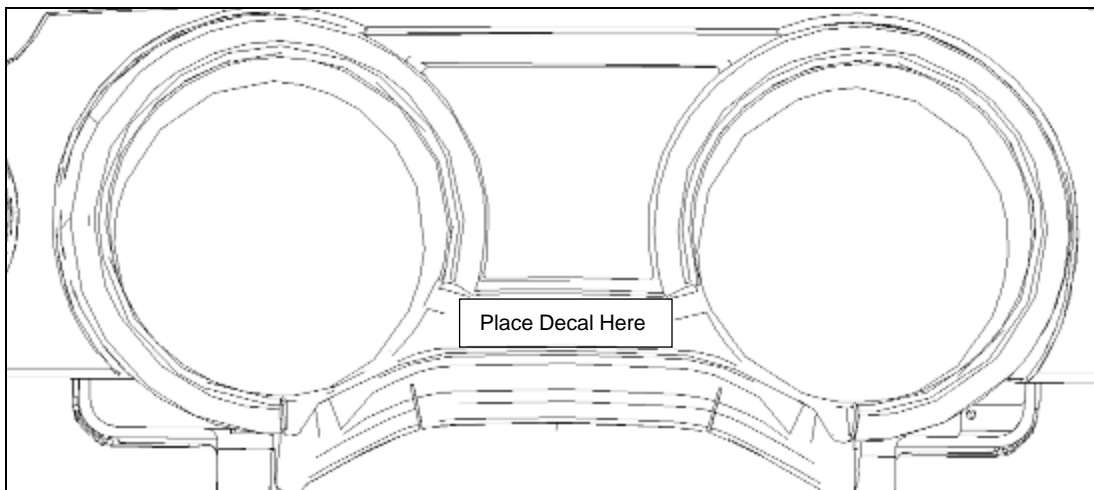

13. Place the EO Label (D418\*\*-9A095EO) on the bottom side of the hood or along the radiator close out panel.
14. **If performing the PCM Flash procedure, proceed to the “PCM Flashing” section. If the PCM was sent to ROUSH for the Optional ROUSH Performed Flash and it has been reinstalled,** start the engine and check for unusual noise, dash service lights, and/or unusual operation. If problems are detected, immediately stop the engine or vehicle, diagnose and repair the problem.

15. Congratulations, you can now go enjoy your new ROUSHcharged 6.2L F-150.



**PREMIUM FUEL REQUIRED – NOT E85 COMPATIBLE**

### PCM Flashing

1. If equipped with a SAE J2534 pass through device, refer to the RDT-CALIM manual found online at [rdt.roush.com](http://rdt.roush.com) (link on main page). The RDT-CALIM manual will guide you through the ROUSH Diagnostic Tool (RDT) software installation process and the ROUSH PCM flashing procedure. **OPERATING THE ENGINE WITHOUT THE RECALIBRATED PCM WILL RESULT IN ENGINE DAMAGE OR FAILURE AND WILL VOID THE WARRANTY.**
2. Once the PCM has been successfully re-calibrated, start the engine and check for unusual noises, dash service lights, and unusual operation. If problems are detected, immediately stop the engine or vehicle, diagnose and repair the problem.