

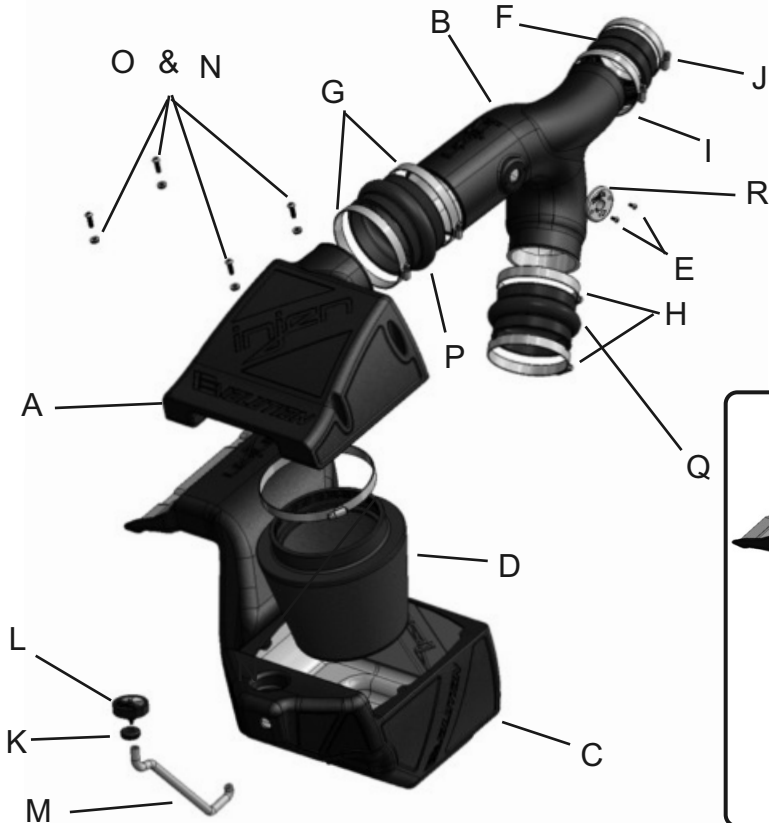

Vehicle Application:			
Make:	Ford		
Model:	F-150 EcoBoost		
Year:	2015		
Engine:	2.7L/3.5L V6 Turbo		

Exploded View



Item	QTY.	P/N	Discription
A	1	#15089	Plenum
B	1	#15092	Intake tube
C	1	#15091	Air Box
D	1	#1065	Dry filter
E	2	#6047	M4 Button Head Screws
F	1	#3124	3.50"-3.25" Step Hose
G	2	#4014	#72 Clamps
H	2	#4006	#64 Clamps
I	1	#4005	#56 Clamps
J	1	#4004	#48 Clamps
K	1	#8026	Grommet
L	1	#15040	Filter Minder
M	1	#3198	3mm Vacuum Line @ 16"L
N	4	#8047	Rubberized Washer
O	4	#6100	M6X20mm Phillips Screws
P	1	#3200	4.5" Hump Hose
Q	1	#3168	4.00" Step Hose
R	1	#15097	Air temp sensor adapter

TOOLS REQUIRED	
10mm Ratchet & Socket	
8mm nut driver	
Allen key	
Phillips Screwdriver	
2.5mm Allen	
13mm socket and ratchet	

WARNING: FAILURE TO FOLLOW INSTALLATION INSTRUCTIONS AND NOT USING THE PROVIDED HARDWARE MAY DAMAGE THE INTAKE SYSTEM, ENGINE AND COMPONENTS!!!
***Do not attempt to install the intake system while the engine is hot.**
 Severe burn could result from touching hot engine components!

Report any defective or missing parts to the authorized Injen dealer you purchased this product from. Before installing any parts of this system, please read the instructions thoroughly. If you have any questions regarding installation, please contact your Injen Technology dealer. Installation DOES require some mechanical skills. A qualified mechanic is always recommended.

A Limited Lifetime Warranty to the original purchaser against defects in material and workmanship on all Injen intake systems excluding the filter element. Any and all warranty coverage is limited to the repair or replacement of the defective part only, at Injen Technology's discretion. The warranty does not cover incidental or consequential damages, nor does it cover the cost of installation or removal of the defective part or its replacement. Proof of purchase is required.

Instruction Manual P/N:EVO9102

NOTE: This intake kit may not work on vehicles with the following aftermarket modifications.

- Aftermarket Intercooler piping
- Aftermarket intercooler
- Turbo upgrade
- Modified body panels
- Suspension & Chassis modifications

Injen intake systems are street legal in most states unless the state is adopting to California Emissions standards. States that have adopted California emission standards include: Arizona, California, Connecticut, District of Columbia, Maine, Maryland, Massachusetts, New Jersey, New Mexico, New York, Oregon, Pennsylvania, Rhode Island, Vermont, and Washington. These states will require an California Air Resource Board Executive Order Number (CARB E.O.) for the legal use of an Injen intake system in your vehicle for use on public roads or highways. These vehicle will be considered "Legal in California only for racing vehicles competition use only, which may never be used upon a public street or highway. **Please keep your factory air box assembly for any future use.**



The SuperNano-Web filter media is a dry synthetic media that outperforms the competition. The media itself is a proprietary base blend of synthetics and cellulose. Cellulose fibers are larger than synthetic fibers, and have larger spaces between the fibers, causing contaminants to load in the depth of the media and plug the airflow path. This creates higher restriction levels and less capacity. The synthetic fibers in the SuperNano-Web media are submicron in diameter and have small interior fiber spaces, which result in more contaminants being captured on the surface of the media. This can help keep restriction levels low as the filter loads with dirt and containments

If you look at the picture to the left, you can see the Nano-fiber web on top of our base media. That web, or SuperNano-Web as we like to call it, helps trap smaller particles and protect your engine.

To Clean your filter:

Carefully remove the filter from the housing. Once removed, wipe down the housing using a clean shop towel, being careful not to knock any dirt and/or debris in the air inlet. Your filters can be cleaned by carefully vacuuming the filter media from the dirty side, or by holding the filter with one hand and carefully blowing the filter media at a 45-degree angle from the clean side using low-pressure shop air (15-20 lbs. psi).

****IT IS IMPORTANT TO NOT USE ANY CLEANERS ON THE SUPERNANO-WEB MEDIA OR APPLY ANY OIL!!!***

NOTE: DISCONNECT BATTERY BEFORE INSTALLATION!!!

Instruction Manual P/N:EVO9102



1. Stock intake system shown.

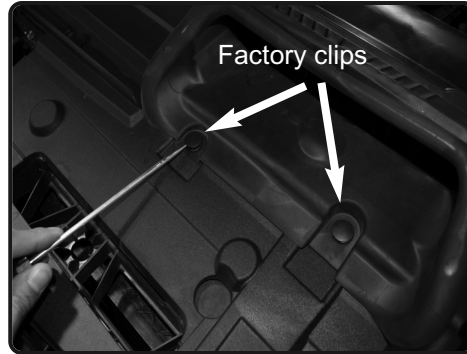

2. Remove the two plastic retaining rivets from the air scoop and remove scoop from engine bay.

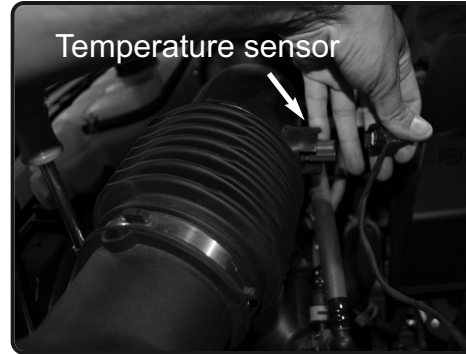

7. Disconnect the temperature sensor harness.

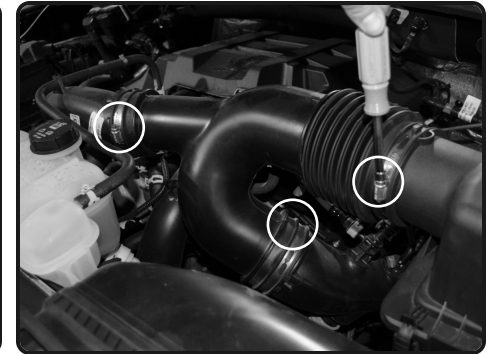

3. Loosen the 3 clamps on the stock intake tube using 7mm nut driver.

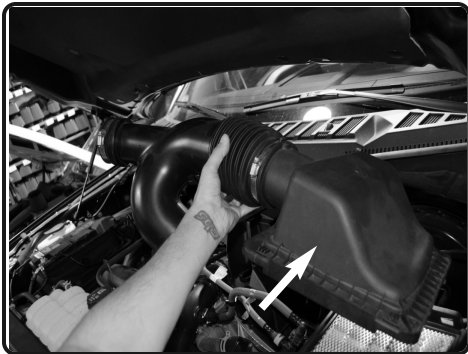

4. Un-clip the upper half of the air box attached to bottom of air box. Remove stock assembly out of vehicle.

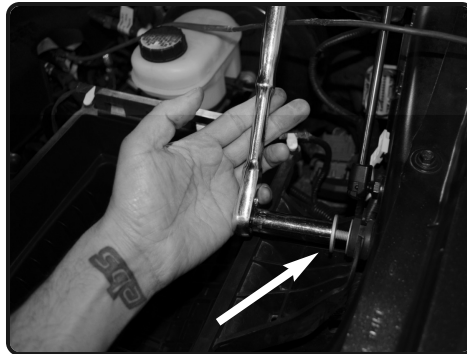

5. Loosen the bolt holding in the bottom of the airbox using 13mm socket or wrench.

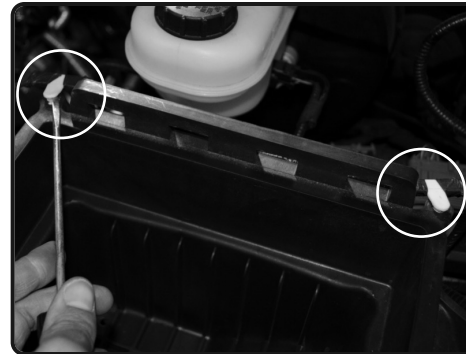

6. Pull back the temperature harness from the air box.

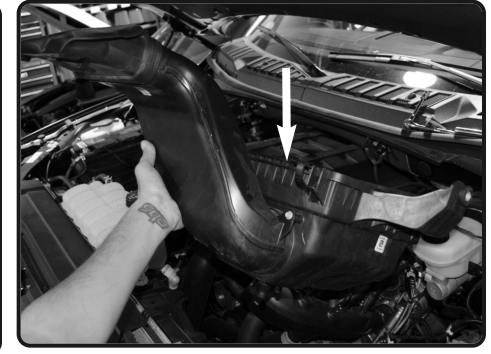

7. Now lift up and remove the bottom half of air box out of vehicle.



8. Loosen and remove the temperature sensor out of stock intake. Use a small flat head screwdriver to pull back clip on sensor.



9. Remove the grommet and spacer from the OE lower air box and re-install it in the Injen lower air box.



10. Install the supplied grommet into the Injen lower air box and then push the 3mm vacuum line and Filter Minder through the grommet.



11. Lower the Injen lower air box into the engine bay. Make sure you line up the stand offs on the bottom side of the Injen lower air box to the grommets on the chassis.

Instruction Manual P/N:EVO9102



12. Use the OE air box bolt to secure the lower Injen air box to the chassis

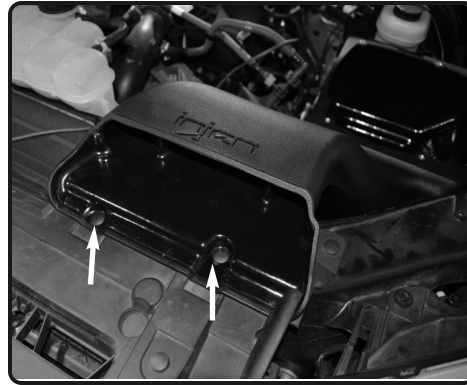

13. Re-use the two plastic retaining rivets from figure 2 to secure the Injen lower air box scoop to the radiator support

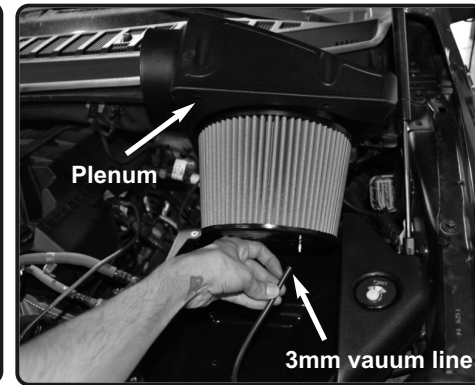

14. Place the filter onto the Injen plenum and connect the 3mm vacuum line from the Filter Minder to the barbed fitting on top of the filter



15. Place the plenum onto the top of the Injen lower air box. Use 4-M6X20 bolts to secure the plenum to the Injen lower air box

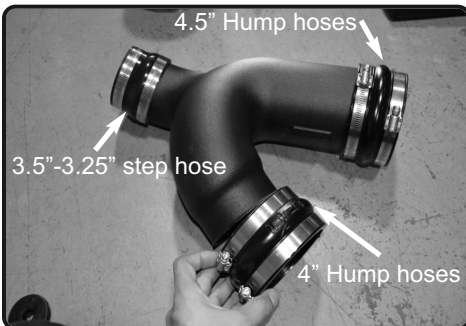

16. Place the supplied hoses illustrated in the photo. The # 72 clamp will be used on the 4.0" and 4.5" hump hoses and #64 and #56 clamps will be used for the 3.5"-3.25" step hose.

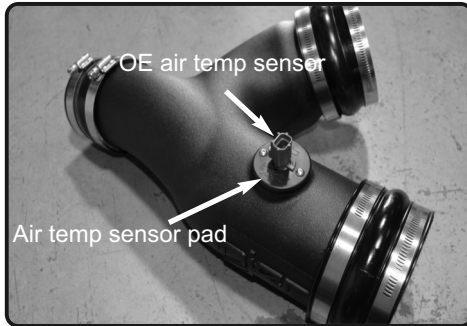

16. Use the supplied M4 bolts to secure the Molded air temp sensor pad onto the Injen intake pipe and then push the AIT sensor into the sensor pad and twist to secure the AIT sensor to the sensor pad



18. Install the Injen intake tube to the factory intake tubes and then connect the Injen intake tube to the Injen intake air box. make your final adjustment and then secure all the clamps



Congratulations! You have just completed the installation of this intake system. Periodically, check the alignment of the intake, normal wear and tear can cause nuts and bolts to come loose. **Note: Check clearance and adjust if needed! Failure to check the alignment and adjust the intake can cause damage that will void the warranty. Injen Technology is not responsible for any damages caused by/from improper installation.**

Test Drive:

1. With the transmission in neutral or park and the parking brake engaged, start the engine. Listen for air leaks or odd noises. If air leaks are detected, secure hoses and connections. For any odd noises, inspect entire system for cause and adjust intake as needed. The Injen intake will function identically to the factory system but will be louder and more powerful.
2. Perform a road test. Listen for odd noises or rattles and fix as necessary.
3. If there are no issues, continue to enjoy your added performance from the Injen performance Intake kit.
4. Injen Technology recommends you periodically check clearance and adjust if needed! Failure to check the alignment and adjust the intake can cause damage that will void the warranty. Injen Technology is not responsible for any damages caused by/from improper installation.

1. Upon completion of the installation, reconnect the negative battery terminal before you start the engine.
2. Align the entire intake system for the best possible fit. Once the intake has been properly fitted continue to tighten all nuts, bolts and clamps.
3. Periodically, recheck the alignment of the intake system and make sure there is proper clearance around and along the length of the intake. Failure to follow proper maintenance procedures may cause damage to the intake and will void the warranty.
4. Start the engine and listen carefully for any odd noises, rattles and/or air leaks prior to taking it for a test drive. If any problems arise go back and check the vacuum lines, hoses and clamps that maybe causing leaks or rattles and correct the problem.
5. Check the filter for excessive dirt build up. Clean or replace the filter with an original Injen filter (can be bought on-line at "injenon-line.com"). Congratulations! You have just completed the installation of the best intake system sold on the market. Enjoy the added power and performance of your new intake system.