



INSTALLATION INSTRUCTIONS
BLACK MODULAR GRILL GUARD FOR FORD F150 15-17
PART # 17FP32MA

Before Installation

- Please read the instruction completely for easy installation, which will also help you to avoid scratches or other potential damages to your appealing car.
- The information shown here is for reference only and may differ from the product that you receive, however the goods are fitted in the same way.





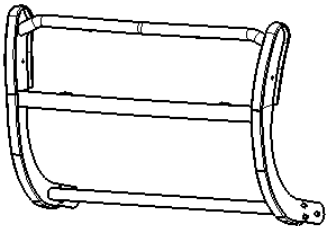
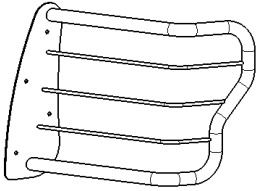
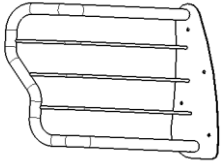
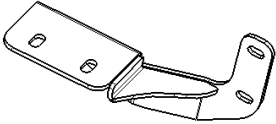
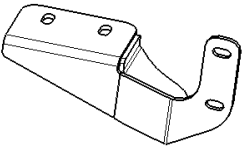
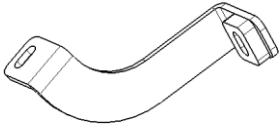

Care and Cleaning

- Mild soap may be used also to clean the Product.
- Please periodically check and retighten all the hardware and clean the investment for a refresh look.

Parts list

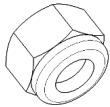
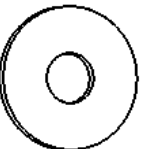
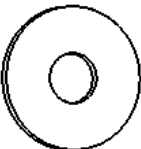
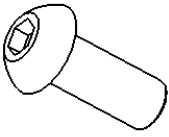
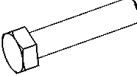
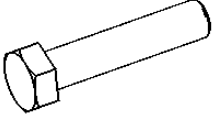
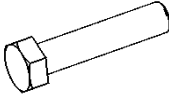
NO.	QTY	NAME	NO.	QTY	NAME
①	1	 Front Guard	②	1	 Left Brush Guard
③	1	 Right Brush Guard	④	1	 Driver/left Frame Bracket
⑤	1	 Passenger/right Frame Bracket	⑥	1	 Driver/left Top Bracket

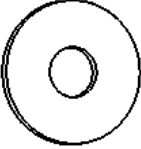
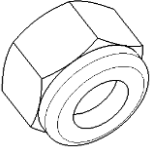
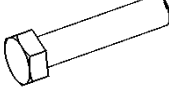
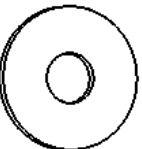
BLACK MODULAR GRILL GUARD FOR FORD F150 15-17

<p>⑦</p> <p>1</p>		 <p>Driver/left Top Bracket</p>	<p>⑧</p> <p>1</p>		 <p>Allen wrench S=5</p>
<p>⑨</p> <p>4</p>		 <p>Split lock washer D12</p>	<p>⑩</p> <p>10</p>		 <p>Hex Nylon Lock Nut M8</p>
<p>⑪</p> <p>4</p>		 <p>Flat Washer D12</p>	<p>⑫</p> <p>16</p>		 <p>Large Washer D8</p>
<p>⑬</p> <p>8</p>		 <p>Socket head cap screw M8_25</p>	<p>⑭</p> <p>2</p>		 <p>hex bolt M8_30</p>
<p>⑮</p> <p>4</p>		 <p>hex bolt M12_35</p>	<p>⑯</p> <p>4</p>		 <p>10mm x 30mm Hex Bolts</p>
<p>⑰</p> <p>2</p>		 <p>Split lock washer D8</p>	<p>⑱</p> <p>6</p>		 <p>Flat Washer D8</p>
<p>⑲</p> <p>4</p>		 <p>10mm Nylon Lock Nuts</p>	<p>⑳</p> <p>2</p>		 <p>hex bolt M8_40</p>
<p>㉑</p> <p>8</p>		 <p>10mm Flat Washers</p>	<p>㉒</p> <p>2</p>		 <p>Double Nut Plate</p>

Installation Step

Install left and right brush guard on the front guard as figure 1.

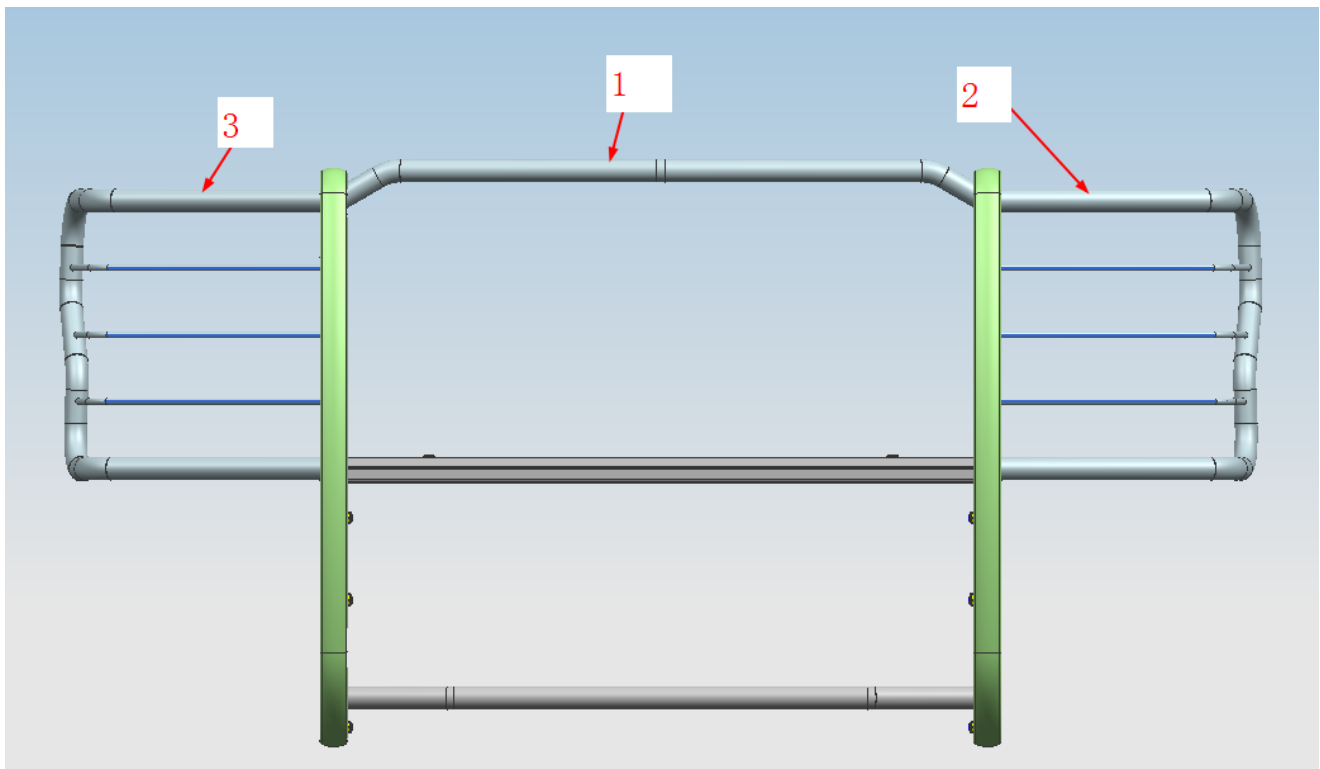
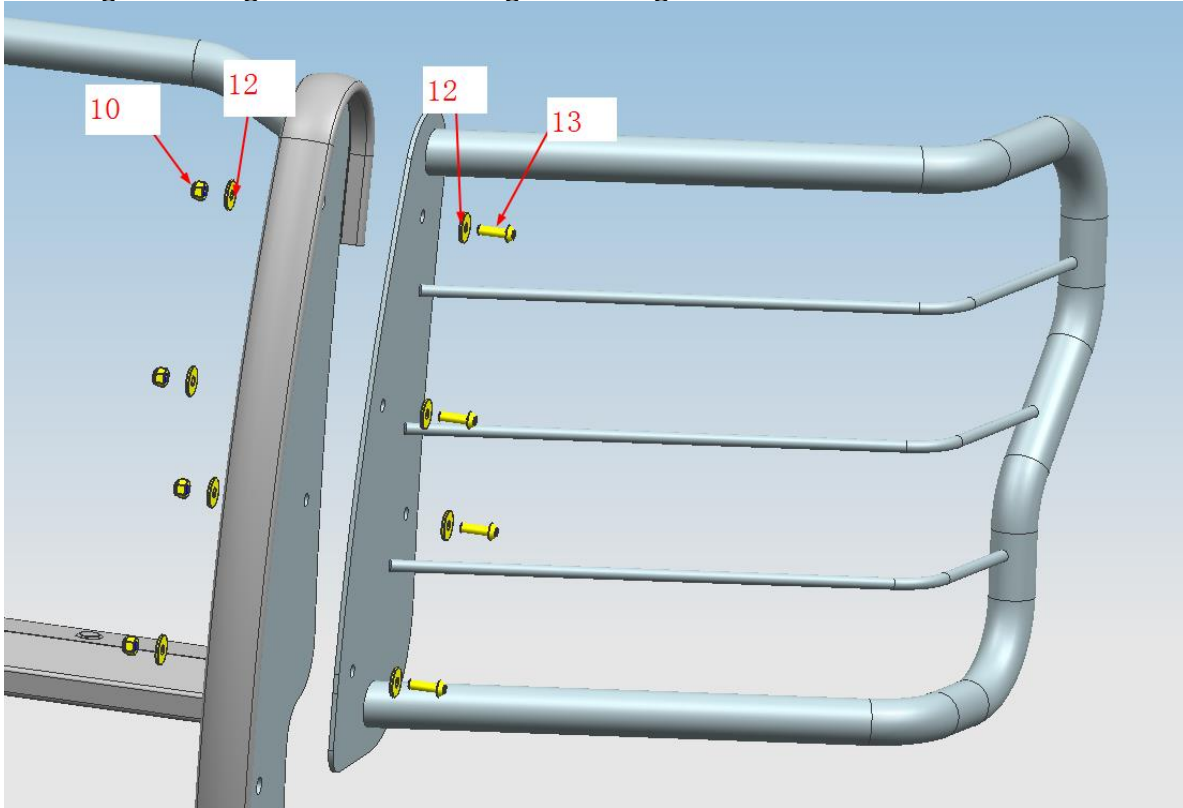

PROCEDURE:

REMOVE CONTENTS FROM BOX. VERIFY ALL PARTS ARE PRESENT. READ INSTRUCTIONS CAREFULLY BEFORE STARTING INSTALLATION. ASSISTANCE IS RECOMMENDED. CUTTING IS REQUIRED ON VEHICLES WITHOUT TOW HOOKS. NOTE: It may be necessary to remove/relocate the front license plate and license plate bracket on models equipped with Ecoboost engine.

Step1.2015-17 Models Top Support Bracket installation:

- a. From under and behind the bumper, locate the top of the driver side bumper bracket, **(Figures 1, 5 & 6)**. Next, locate the center bumper bolt attaching the top of the bracket to the back of the bumper. It may be necessary to temporarily release the clips and move the rubber cover to access the bumper bolts, **(Figure 1)**.
- b. Remove the hex bolt from the top-center of the bumper bracket, **(Figures 2, 4, 6 & 7)**. **NOTE:** On some models, it may be necessary/easier to remove bumper to install Top Brackets.
- c. Select the driver side Top Bracket, **(Figure 3)**. Insert the Top Bracket, (end with welded spacer), into the space between the top of the bumper and the bottom of the grille. Line up the Bracket with the mounting hole in the bumper bracket.
- d. Attach the driver/left Top Support Bracket to the back of the bumper bracket with the included (1) ⑳ 8mm x 40mm Hex Bolt, (1) ⑰ 8mm Split Lock Washer and (1) ⑲ 8mm Flat washer, **(Figures 3—6)**. Leave loose at this time.
- e. Repeat to install the passenger side Top Bracket.

Determine if the **2015-17** model vehicle is equipped with factory tow hooks, **(Figures 7 & 9)**.

Step2.2015-17 Frame Bracket Installation on vehicles with Factory Tow Hooks:

- a. Remove both tow hooks and plastic trim. **NOTE:** Plastic trim will not be reinstalled.
- b. Select the driver side Frame Mounting Bracket, **(Figure 8)**. Insert the Bracket between the tow hook and the frame.
- c. Reattach the tow hook over the Bracket with the factory bolts. Leave hardware loose. If Bracket installation interferes with tow hook, remove tow hook and attach the Bracket to the bottom of the frame and Nut Plate with the included (2) ⑮ 12mm x 35mm Hex Bolts, (2) ⑨ 12mm Split Lock Washers and (2) ① 12mm Flat Washers, **(Figure 8)**
- d. Repeat for passenger side Frame Bracket installation.

2015-17 Frame Bracket Installation on Models without Tow Hooks:

- a. From behind the bumper, release the clips attaching the plastic bumper pads to the steel bumper, **(Figures 9—11)**. Temporarily remove the pads and license plate mounting bracket. Next, remove the air dam and plastic splash guard from the bottom of the bumper.
- b. Insert (1) ㉒ 12mm Double Nut Plate into the end of the driver side of the frame, **(Figures 12 & 13)**. Line up the Nut Plate with the holes in the bottom of the frame, **(Figure 14)**.
- c. Select the driver side Frame Mounting Bracket. Attach the Bracket to the bottom of the frame and Nut Plate with the included (2) ⑮ 12mm x 35mm Hex Bolts, (2) ⑨ 12mm Split Lock Washers and (2) ① 12mm Flat Washers, **(Figures 8 & 16)**. Leave hardware loose at this time.
- d. Repeat the previous **Steps a—c** for passenger side Frame Mounting Bracket installation.
- e. Hold splash guard up against bottom of brackets and in line with mounting points on bottom of bumper. Mark location of brackets onto splash guard, **(Figure 15)**.
- f. Cut out slots to clear brackets. Cut as little as possible to clear brackets.
- g. Temporarily remove the Frame Brackets.
- h. Reinstall the splash guard and reinstall Brackets through splash guard. Proceed to **Step 3**.

- Step3.**
- a. With assistance, place the Grille Guard up to the outside of the Brackets. Attach the Grille Guard to the Frame Brackets with (4) ⑯ 10mm x 30mm Hex Bolts, (8) ㉑ 10mm Flat Washers and (4) ⑲ 10mm Nylon Lock Nuts, **(Figures 17)**. Snug but do not tighten hardware at this time.

BLACK MODULAR GRILL GUARD FOR FORD F150 15-17

- b. Line up the driver side Top Bracket with the hole in the upright on the Grille Guard. Attach the Bracket to the Grille Guard with (1) ⑭ 8mm x 30mm Hex Bolt, (2) ⑱ 8mm Flat Washers, (1) ⑩ 8mm Nylon Lock Nut, (**Figures 17**). Repeat to attach the passenger side Top Bracket to the Grille Guard.
- c. Center the Grille Guard on the vehicle. Once properly adjusted, fully tighten all hardware.
REMINDER: On 2015-17 models only, fully tighten hex bolts attaching Top Support Brackets to back of bumper.
- d. Do periodic inspections to the installation to make sure that all hardware is secure and tight.

To protect your investment, wax this product after installing. Regular waxing is recommended to add a protective layer over the finish. Do not use any type of polish or wax that may contain abrasives that could damage the finish.
For stainless steel: Aluminum polish may be used to polish small scratches and scuffs on the finish. Mild soap may be used also to clean the Grille Guard.

For gloss black finishes: Mild soap may be used to clean the Grille Guard.

Driver Side Installation Pictured

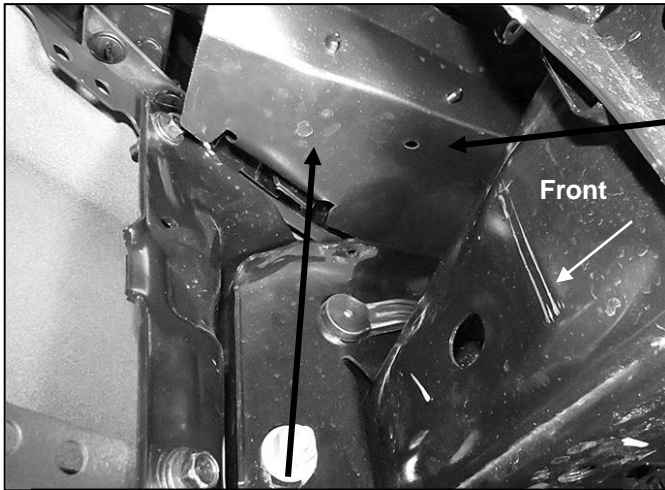

(Fig 1) Release clips attaching rubber cover to back of bumper above bumper brackets

2015-17 models: From behind bumper, release clips attaching rubber cover to back of bumper above bumper brackets to access the bumper bolts (Fig 7). Insert the Top Bracket (Fig 9 & 12) into gap between top of bumper and bottom of grille.

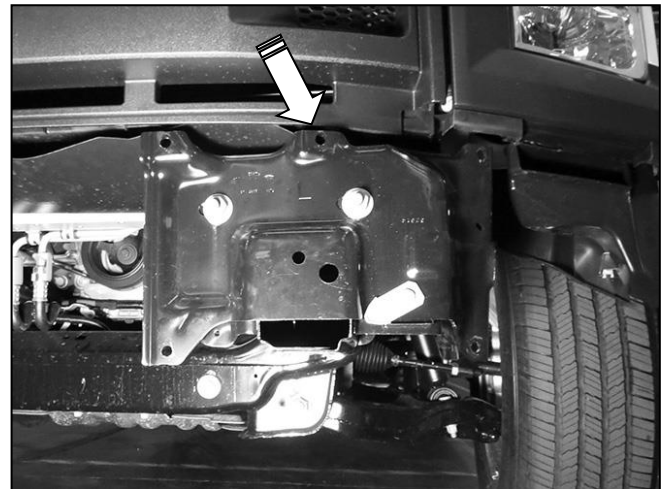

(Fig 2) 2015-17 models: Locate the top bumper bolts. Remove the driver side middle bolt (see arrow-bumper pictured removed for reference only-do not remove bumper)

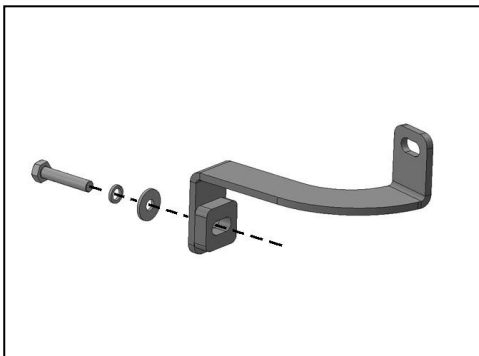

(Fig 3) 2015-17 Driver side Top Bracket

**BLACK MODULAR GRILL GUARD FOR FORD F150 15-17
Driver Side Installation Pictured**

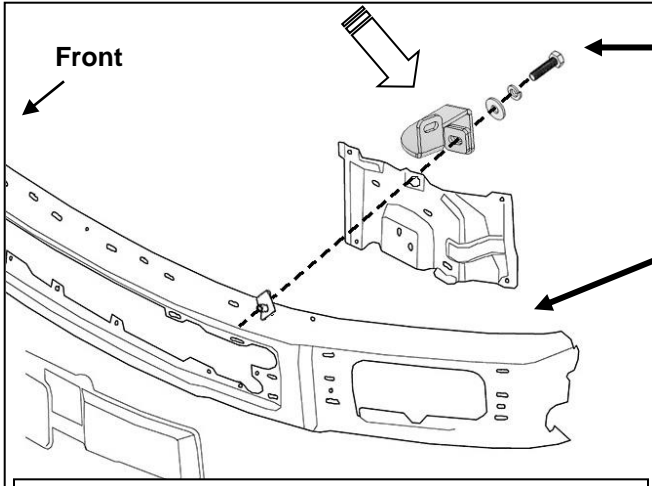

8mm x 40mm Hex Bolt
8mm Split lock washer
8mm Flat Washer

From behind bumper, release clips attaching rubber cover to back of bumper above bumper brackets to access the bumper bolts (Fig 7). Insert the Top Bracket (Fig 9 & 12) into gap between top of bumper and bottom of grille.

(Fig 4) 2015-17 models: Attach the driver side Top Bracket to the back of the middle mounting hole on the top of the bumper bracket

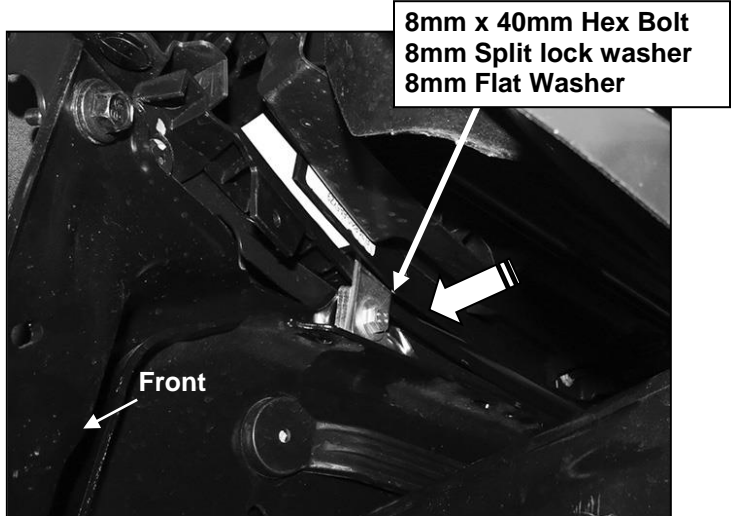

8mm x 40mm Hex Bolt
8mm Split lock washer
8mm Flat Washer

(Fig 5) 2015-17 models: Attach the driver side Top Bracket to the middle mounting hole on the top of the bumper bracket (pictured from behind bumper)

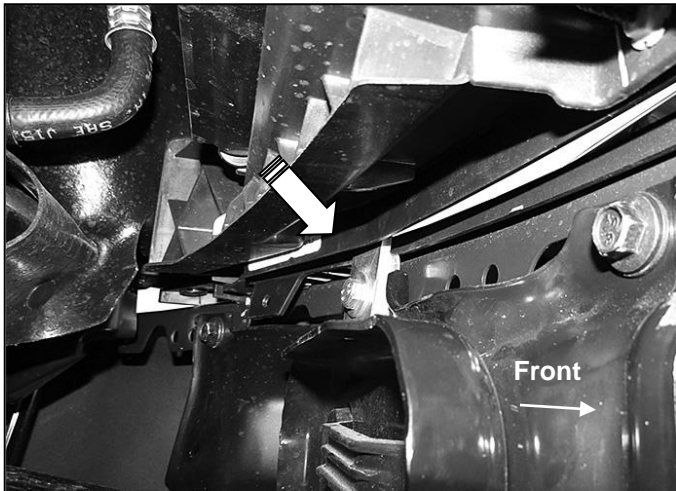

(Fig 6) 2015-17 models: Attach the driver side Top Bracket to the middle mounting hole on the top of the bumper bracket (pictured from behind center of bumper)

Remove tow hooks and plastic trim around tow hooks



(Fig 7) Passenger side 2015-17 model w/tow hook

Driver Side Installation Pictured



- (2) 12mm x 35mm Hex Bolts
- (2) 12mm Split Lock Washers
- (2) 12mm Flat Washers

(Fig 8) Attach Frame Bracket to Nut Plate.



(Fig 9) 2015-17 models: Driver side without tow hook

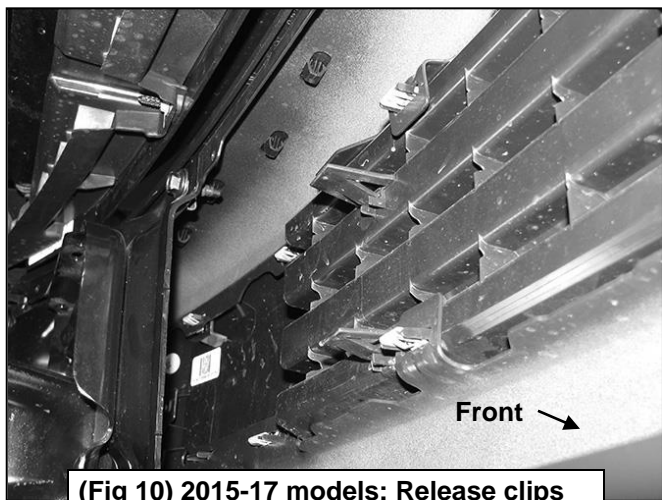

(Fig 10) 2015-17 models: Release clips attaching bumper pad to steel bumper



(Fig 12) 12mm Double Nut Plate

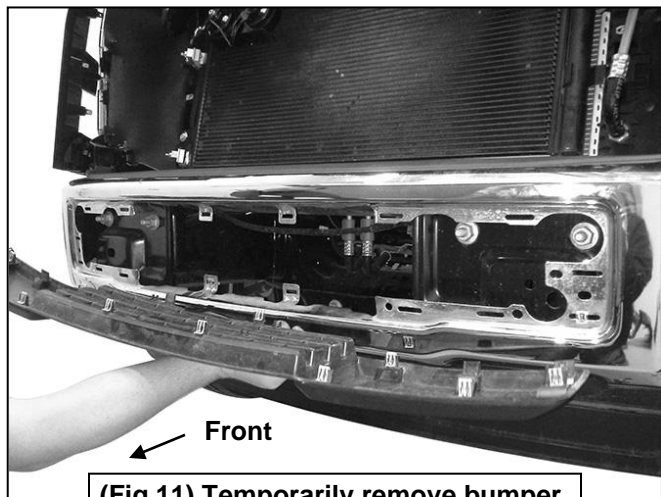

(Fig 11) Temporarily remove bumper pad. Grille removed for instruction purposes only, do not remove grille

BLACK MODULAR GRILL GUARD FOR FORD F150 15-17
Driver Side Installation Pictured

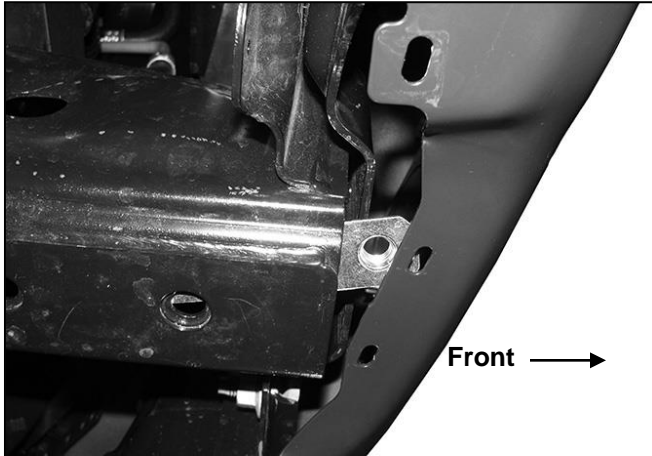

(Fig 13) Insert Nut Plate into open end of frame- applies to models without tow hooks only

Do not cut through front or back edge of splash guard

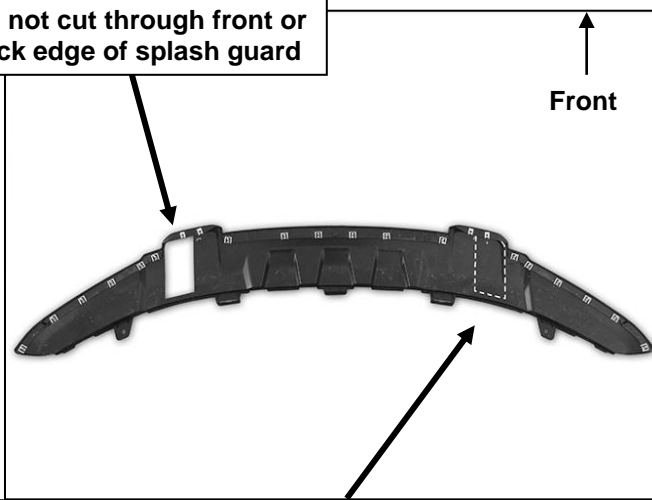
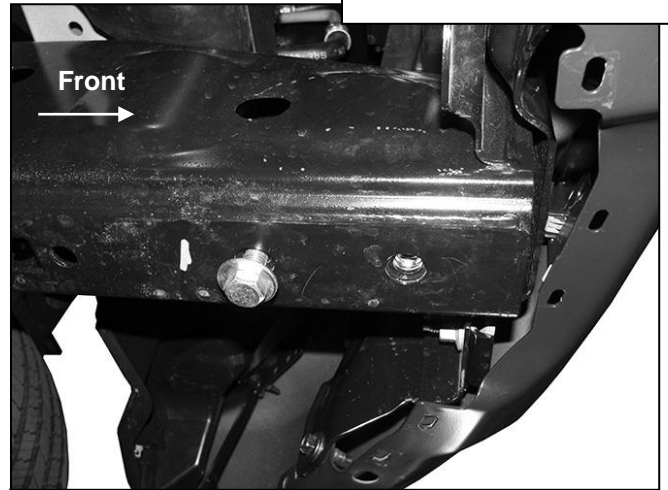
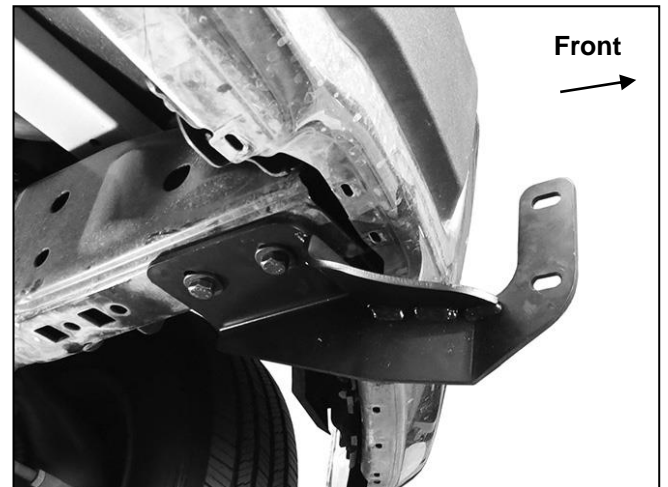

Fig 15) 15-17 models pictured: Hold the splash guard up to the bottom of Frame Brackets. Trace location of Brackets onto back of the plastic cover (dashed line). Cut as required to clear brackets

12mm x 35mm Hex Bolt
12mm Lock Washer
12mm Flat Washer



(Fig 14) Use a Hex Bolt to line up the Nut Plate



(Fig 16) Attach Frame Bracket to Nut Plate.

**BLACK MODULAR GRILL GUARD FOR FORD F150 15-17
Driver Side Installation Picture**

**8mm x 30mm Hex Bolt
(2) 8mm Flat Washers
8mm Nylon Lock Nut**

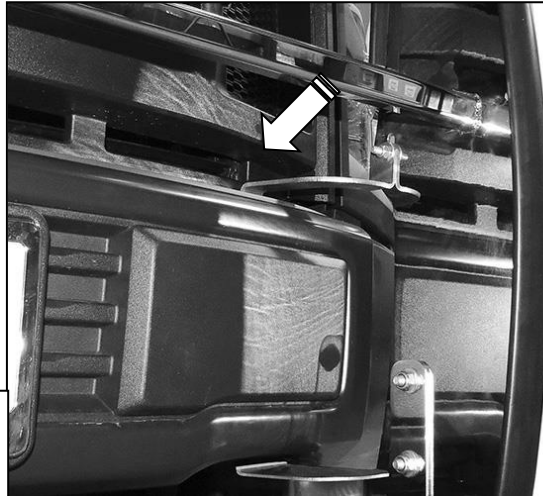

**(2) 10mm x 30mm Hex Bolts
(4) 10mm Flat Washers
(2) 10mm Nylon Lock Nuts**

(Fig 17) 2015-17 models: Complete installation

Complete Installation

