

PARTS LIST:

2	Running Boards	30	8mm x 24mm x 2mm Washer
6	Mounting Brackets (left or right)	12	8mm Lock Washers
6	8mm Double Bolt Plates	12	8mm Hex Nuts
18	8mm Plastic Retainers	18	8-1.25mm Nylon Lock Nuts

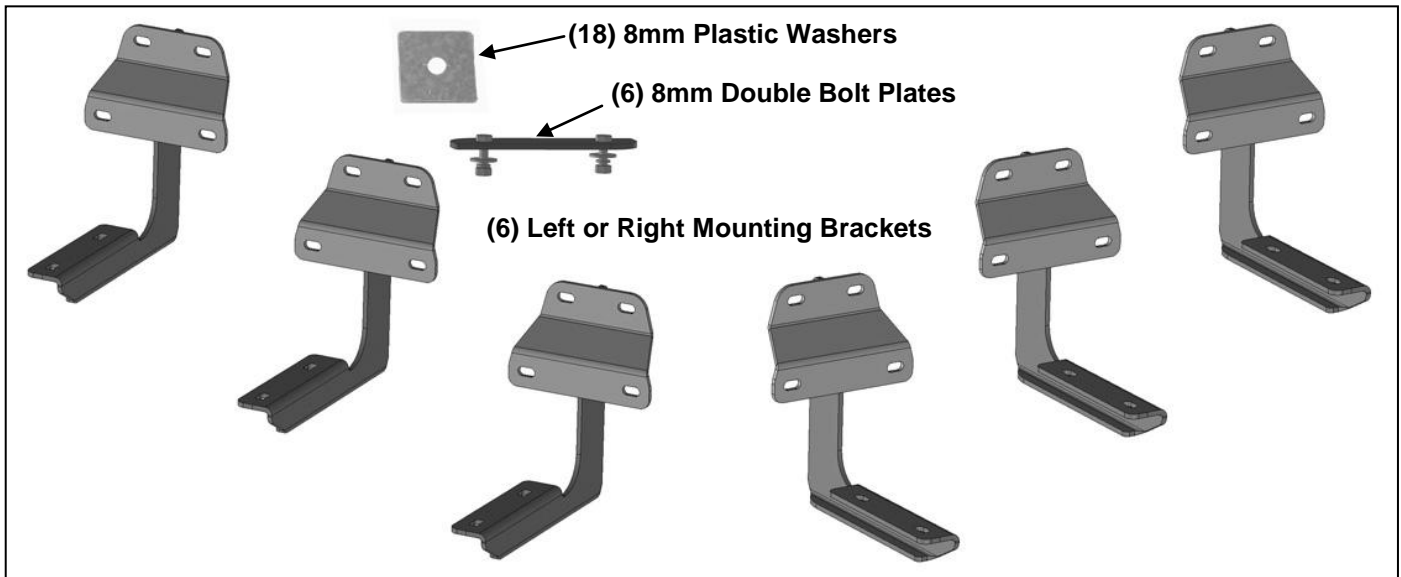

PROCEDURE:

REMOVE CONTENTS FROM BOX. VERIFY ALL PARTS ARE PRESENT. READ INSTRUCTIONS CAREFULLY BEFORE STARTING INSTALLATION. ASSISTANCE IS RECOMMENDED.

1. Start the installation under the driver side of the vehicle. Locate the front factory running board mounting location, (threaded studs), along the inner side of the body, **(Figure 1)**. **IMPORTANT: Clean mounting studs with wire brush to remove paint and debris.**
2. Slide (1) Plastic Washer over each of the (3) factory mounting studs in the body panel, **(Figures 2—4)**. **IMPORTANT: The Plastic Washers are designed to prevent corrosion between the aluminum body panel and the steel mounting brackets. Do not install the Brackets without the Plastic Washers.**
3. Select (1) Mounting Bracket. **NOTE: All (6) Brackets are universal and will fit left or right side. Attach the Mounting Bracket to the (3) factory studs with (3) 8mm Flat Washers and (3) 8mm Nylon Lock Nuts, (Figures 4 & 5).** Leave brackets loose at this time.
4. Repeat **Steps 1—3** to install the center and rear driver side Brackets, **(Figures 6 & 7)**.
5. Carefully unwrap (1) Running Board. Place the Running Board on top of the Brackets. Locate the channels in the bottom of the Running Board. Select (3) 8mm Double Bolt Plates, **(Figure 8)**. Insert the Bolt Plates into the channels in the bottom of the Running Board closest to the Brackets. Lift the Running Board up and guide the studs down through the Brackets.
6. Attach the Running Board to the Brackets with (6) 8mm Flat Washers, (6) 8mm Lock Washers and (6) 8mm Hex Nuts, **(Figures 9 & 10)**. **NOTE: The Running Board is designed to fit close to the vehicle. It may be necessary to loosen the Bracket hardware slightly and tilt the Brackets downward to insert the Running Board between the Brackets and the body.**
7. Level and adjust the Running Board as necessary and fully tighten all hardware. **NOTE: Line up front end of Running Board approximately 2" back from wheel opening or as desired.**
8. Repeat **Steps 1—7** for the passenger/right side Running Board installation, **(Figure 10)**.
9. Do periodic inspections to the installation to make sure that all hardware is secure and tight.

To protect your investment, Do not use any type of polish or wax that may contain abrasives that could damage the finish. Mild soap may be used also to clean the Running Board.

Driver/left Side Installation Pictured

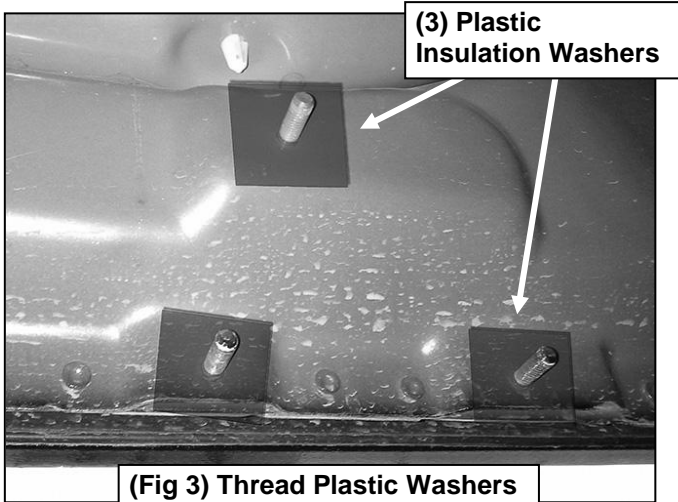
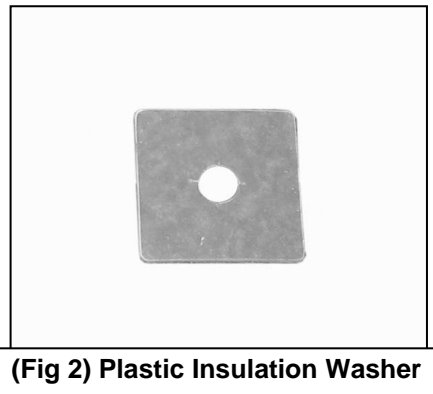
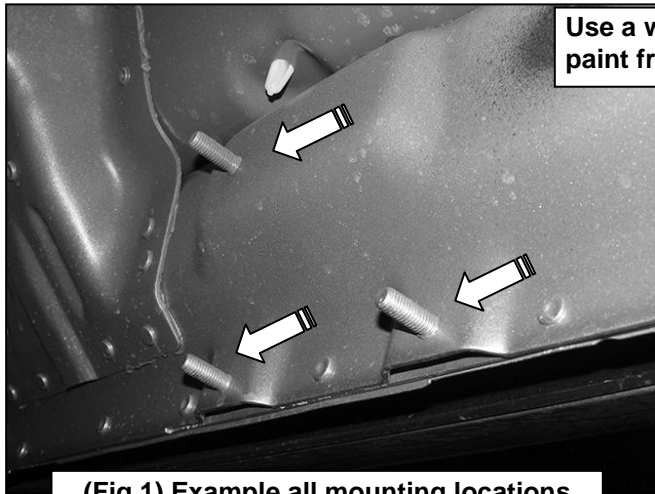

(3) 8mm Flat Washers
(3) 8mm Nylon Lock Nuts

(3) 8mm Plastic Washers

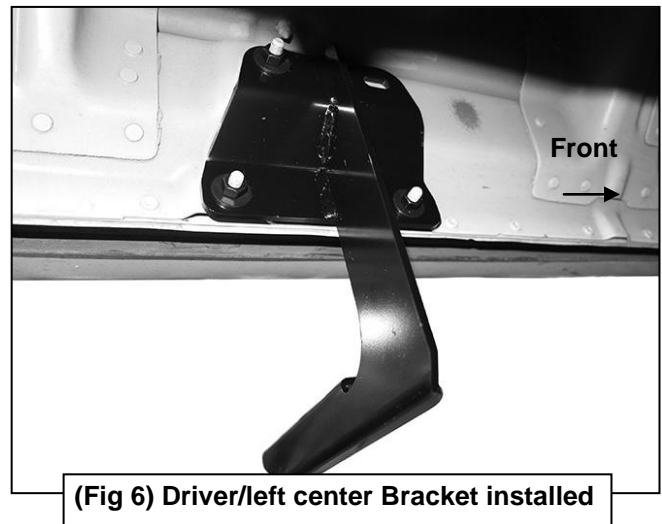
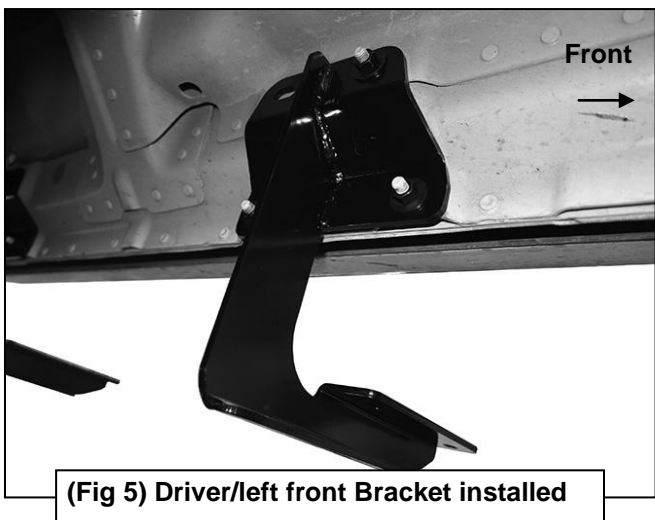
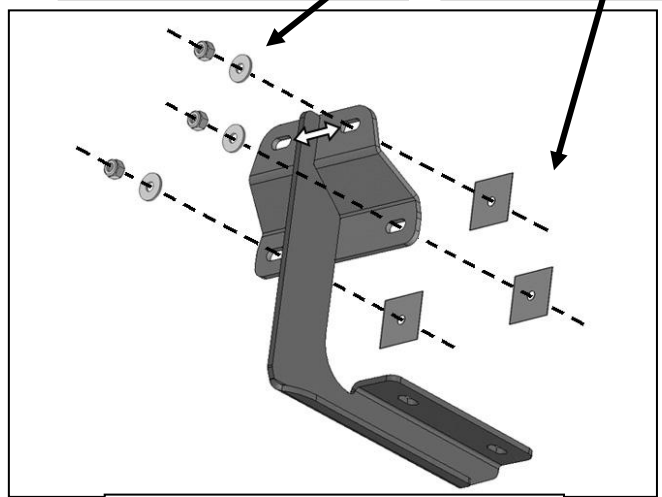

Driver side installation pictured

