



Installation Instructions

**717864**

2009-2014 FORD F-150  
 3.5L ECOBOOST, 4.6L, 5.0L, 5.4L  
 2/4 WHEEL DRIVE & ALL WHEELBASES

**OVERVIEW:**

1. Please take a moment to read and understand these instructions before installing your Flowmaster performance system.

**NOTE:** Please inventory all parts before starting the installation process and call our tech line to report any missing parts. This will help avoid potentially stranding your vehicle until any missing replacement parts arrive.

ITM #	PART #	DESCRIPTION	QTY.
1	26764M	Inlet Pipe	1
2	26277M	Extension Pipe	1
3	71249-Z	FFX Muffler	1
4	26765M	FFX Tailpipe Assembly	1
5	ST509B	Tip	1

ITM #	PART NO.	DESCRIPTION	QTY.
N/A	PK1006	Hardware Pack includes:	1
6	MC300BS	3" Stainless Band Clamp	3
7	382HA	Front Hanger	1
8	HW103	3/8-16 Z 5 Nut	2
9	HW211	3/8-16 x 2 HCS G5 Bolt	2
10	HW303	3/8 Flat Washer	4
11	HW309	3/8 Lock Washer	2

**REMOVE STOCK EXHAUST SYSTEM:**

2. Raise vehicle up on a hoist or rack to working height. If you don't have access to a hoist or rack, support vehicle with jack stands.

**WARNING:**  
 Avoid serious burns! Allow your vehicle time to cool completely before touching any factory engine components.

**To ease disassembly of factory components:**

- Apply penetrating lubricant to mounts, bolts and clamps before you remove them.
- Use stands as necessary to support parts as you detach them from your vehicle.

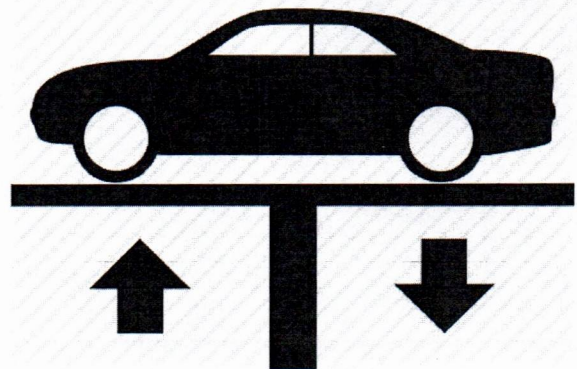

3. Cut exhaust at muffler outlet.

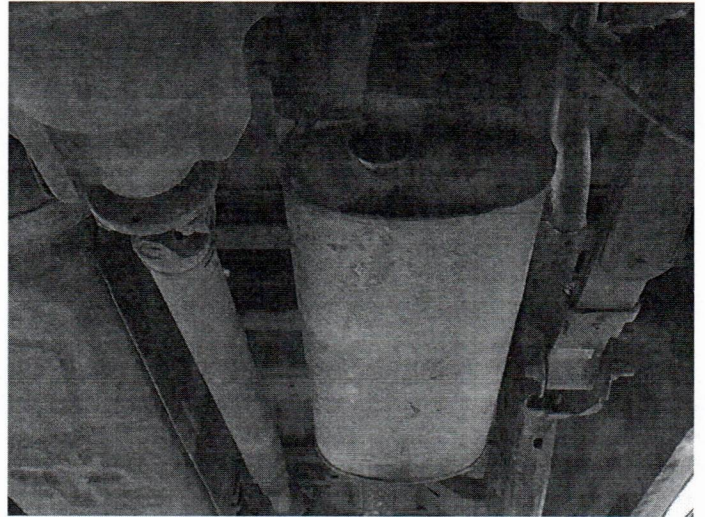
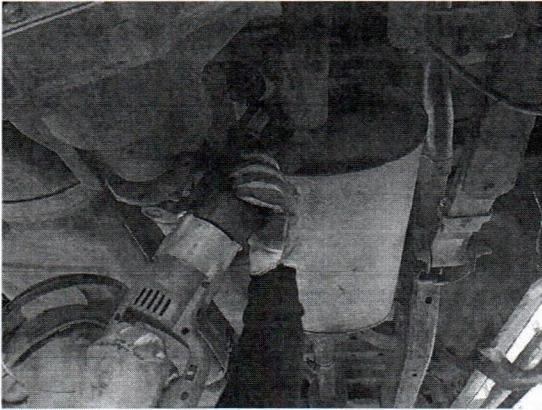

4. Dismount hanger from isolator and remove rear tailpipe section.

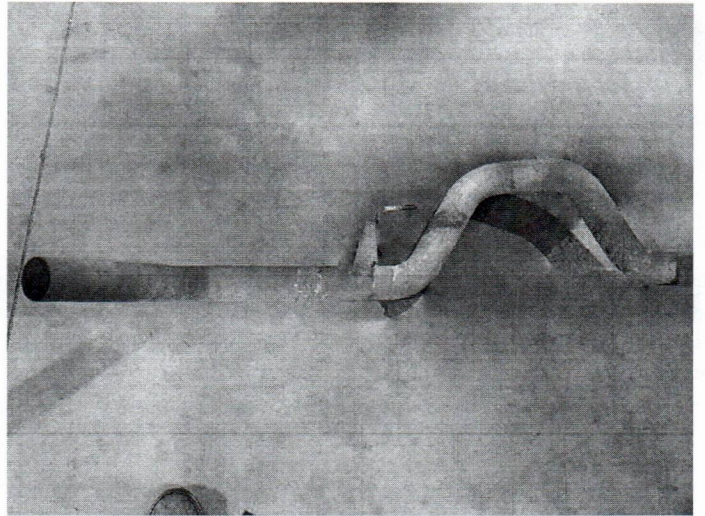
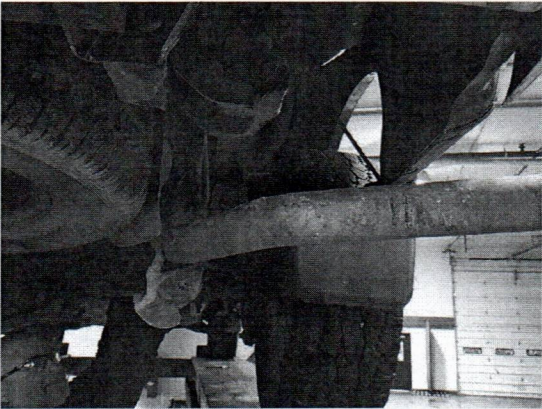

5. Remove bolts (x2) from flange at catalytic converter, disassemble wire hangers from isolators and remove muffler assembly from vehicle.

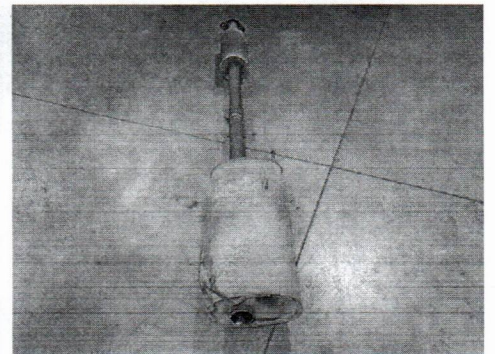
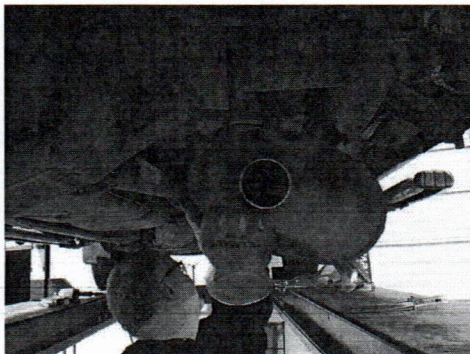

## INSTALL FLOWMASTER EXHAUST SYSTEM

6. Remove nuts from stock and Flowmaster clamps, apply anti-seize compound to bolts and re-install nuts.

**NOTE:** The image in this step is intended for illustrative purposes only and may or may not accurately reflect components included in your kit.

7. Every slip fit connection in this kit must seat 3" deep except for muffler connections which must seat 2" deep. Mark all slip fit components in your kit and mark them accordingly so your Flowmaster exhaust system fits properly onto your vehicle.

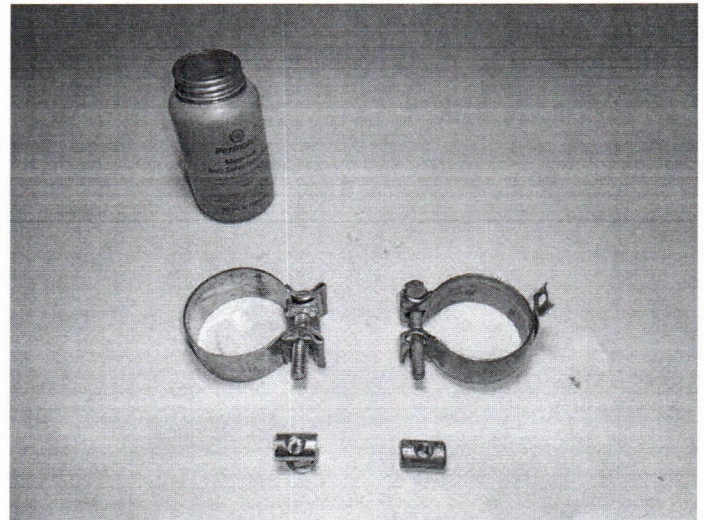

8. Find your vehicle specifications listed below then apply the corresponding modifications or assembly combinations to this kit to ensure it will install properly.

WB	BODY STYLE	BED LGTH	INLET ASSY:	MODIFICATION
126"	Regular Cab	6.5'	Inlet only	Trim 18" from inlet pipe
133"	SuperCab	5.5'	Inlet only	Trim 12" from inlet pipe
145"	SuperCrew	5.5'	Inlet only	None
145"	Regular Cab	8'	Inlet only	None
145"	SuperCab	6.5'	Inlet only	None
157"	SuperCrew	6.5'	Inlet/Extension	Trim 6" from extension pipe
163"	SuperCab	8'	Inlet/Extension	None

9. Loosely fasten inlet pipe (1) to cat. converter using (x2 ea.) bolts (9) through flat washers (10), flanges, flat washers, lock washers (11) and nuts (8).

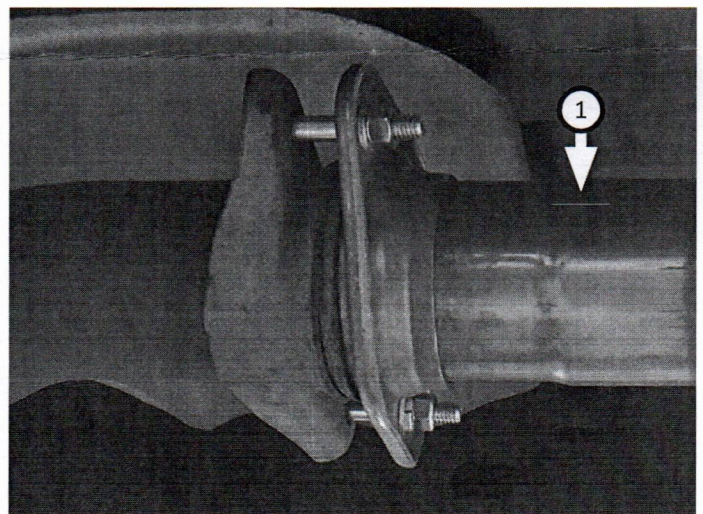

10. For applicable vehicles, place **clamp (6)** onto **extension pipe (2)** and connect it to inlet. Inlet pipe should be offset toward frame of vehicle.

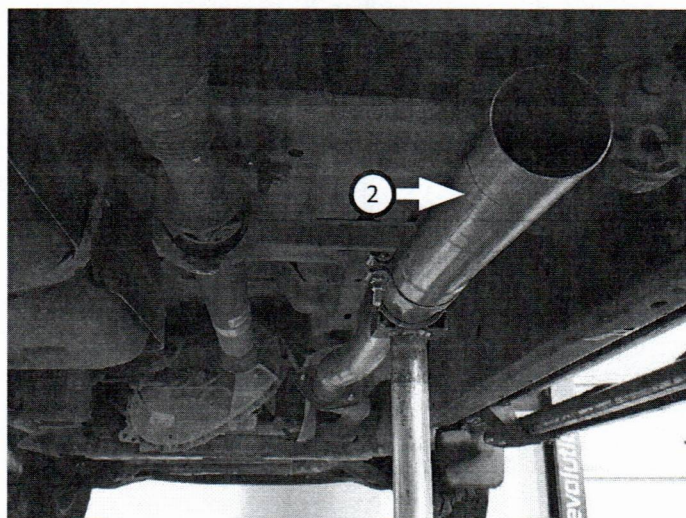

11. Place **front hanger (7)** onto **muffler (3)** then connect it to inlet/extension. Insert hanger into isolator and tighten clamp just enough to allow for adjustment.

**NOTE:** If front hanger is misaligned, re-locate mount slightly forward and down into other mounting holes in frame.

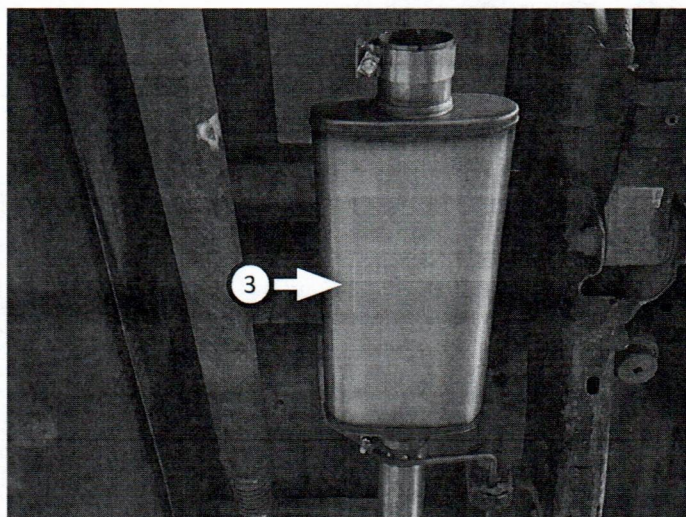
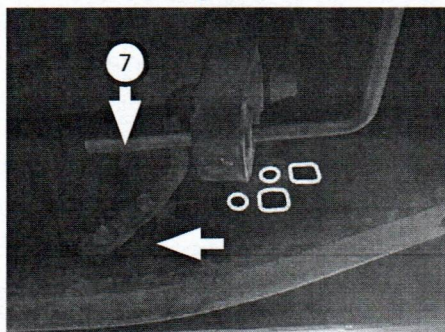

12. Place **clamp (6)** onto muffler outlet. Route **tailpipe (4)** over rear axle and connect it to muffler. Tighten clamp enough to allow for adjustment.

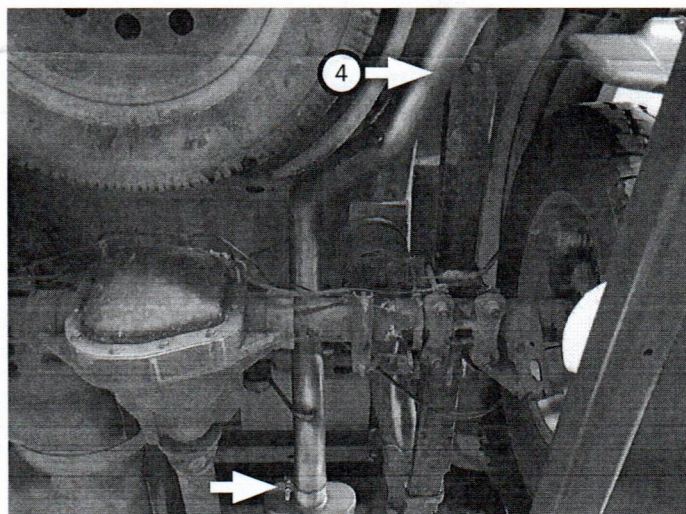

13. Connect **tip (5)** to tailpipe then tighten inlet to secure connection.

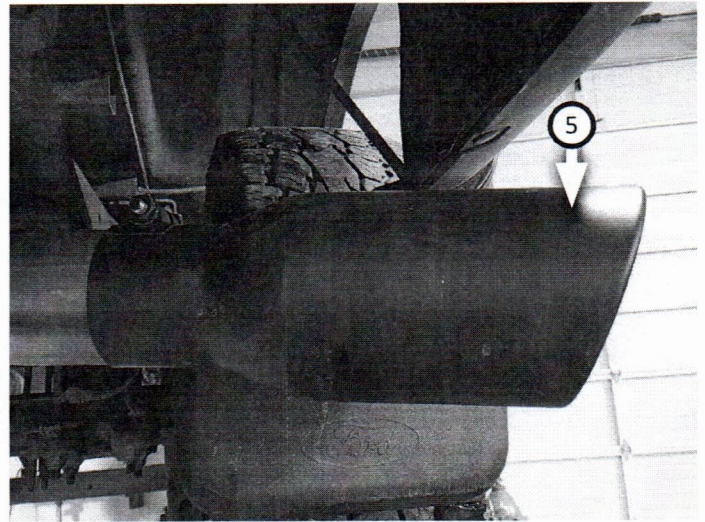

14. Adjust exhaust components to provide a satisfactory fit. Maintain a minimum of 1/2" clearance around all parts, keeping in mind suspension, travel and vibration. After making adjustments, securely tighten all clamps.
15. We recommend applying a one inch tack weld to all slip-fit connections for a more secure installation. You may also apply high temperature paint over welded areas to prevent rust and premature corrosion.

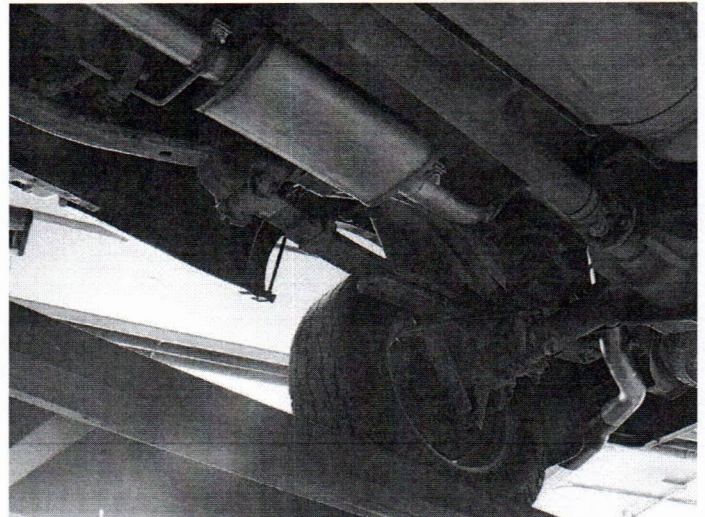

Congratulations, the installation of your FLOWMASTER performance exhaust system is now complete!





Installation Diagram

**717864**

2009-2014 FORD F-150

3.5L ECOBOOST, 4.6L, 5.0L, 5.4L

2/4 WHEEL DRIVE & ALL WHEELBASES

