



INSTALLATION GUIDE

2021-UP/FORD F-150 RAPTOR

EDGE FRONT BUMPER

F210443130103



TOOLS REQUIRED

- (Sockets) 9/16, 3/4, 8mm, 10mm, 13mm, 15mm, 21mm
- (Box end wrenches) 9/16, 3/4, 8mm, 10mm, 13mm, 15mm, 21mm
- (Allen wrenches) 7/32, 5/16
- Fastener remover or flathead screwdriver
- Zip ties
- Ratchet



TIME REQUIRED

- 2 hours for OEM Removal/Bumper Install
- 1 Additional Hour to Wire Lights

****Labor Rates are based on a vehicle with no pre-existing damage. Wiring labor is based on a standard wiring procedure with light switches installed in an easily accessible location. Custom light triggering or switch mounting location will result in a greater labor charge.****



SKILL LEVEL



Easy

****This installation requires 2 people for best results****

⚠️ WARNINGS/CAUTIONS BEFORE STARTING INSTALLATION ⚠️

-BEFORE YOU INSTALL THIS KIT-

Read and understand all instructions, warnings, cautions, & notes contained in this installation instruction guide. Consult your vehicle owner's manual for proper disconnection of electrical and lifting of vehicle if required for installation of this product.

This install may require some technical skills and knowledge of basic mechanical work. If you do not feel that you are capable of performing this install please take this product to a trained professional.

After reading this guide please contact us with any questions or concerns before installing product.
Customer Service (480) 671-0820

Addictive desert designs is *not* responsible for any bodily injury or harm to you or your vehicle as a result of an improper install.

Proper installation of this kit required knowledge of the factory recommended procedures for removal and installation of original equipment components.

We recommend that the factory shop manual and any special tools needed to service your vehicle be on hand during the installation. Installation of this kit without proper knowledge of the factory recommended procedures may affect the performance of these components and the safety of the vehicle.

Inspect all contents of this package to make sure product is not damaged and all installation hardware has been included. If parts are missing from kit, please be prepared to provide the following information:

1. Name of purchase location
2. Bar Code on side of box
3. Date above bar code
4. Date inside box cover

ALWAYS WEAR EYE PROTECTION WHEN OPERATING POWER TOOLS



INSTALLATION GUIDE

HARDWARE/PARTS

A.



3/8-16 X 1" BUTTON HEAD BOLT

QTY: 6

B.

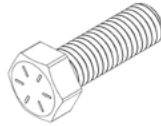

3/8-16 X 1" HEX HEAD BOLT

QTY: 2

C1.



3/8" FLAT WASHER

QTY: 4

C2.



3/8-16" NYLON LOCK NUT

QTY: 4

D.



3/8" FENDER WASHER

QTY: 8

E.

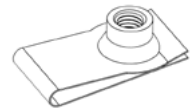

3/8-16" U-NUT

QTY: 4

F.

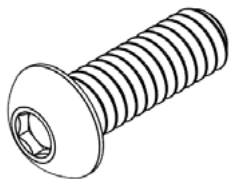

1/2-13 X 1 1/2" BUTTON HEAD BOLT

QTY: 2

F1.



1/2" FLAT WASHER

QTY: 6

F2.

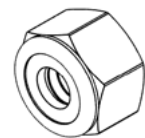

1/2-13" NYLON LOCK NUT

QTY: 2

Reference this page throughout the install



INSTALLATION GUIDE

EDGE FRONT BUMPER 2021-UP/FORD F-150 RAPTOR

REMOVAL

□ STEP 1

Remove the 6x bolts to release the OEM skid plate using a (13mm socket).





INSTALLATION GUIDE

EDGE FRONT BUMPER 2021-UP/FORD F-150 RAPTOR

REMOVAL

□ STEP 2

Remove the skid plate spacer.



EDGE FRONT BUMPER 2021-UP/FORD F-150 RAPTOR

REMOVAL

□ STEP 3

Remove the support brackets holding the bumper to the frame horns using a (8mm socket). (Repeat on other side)

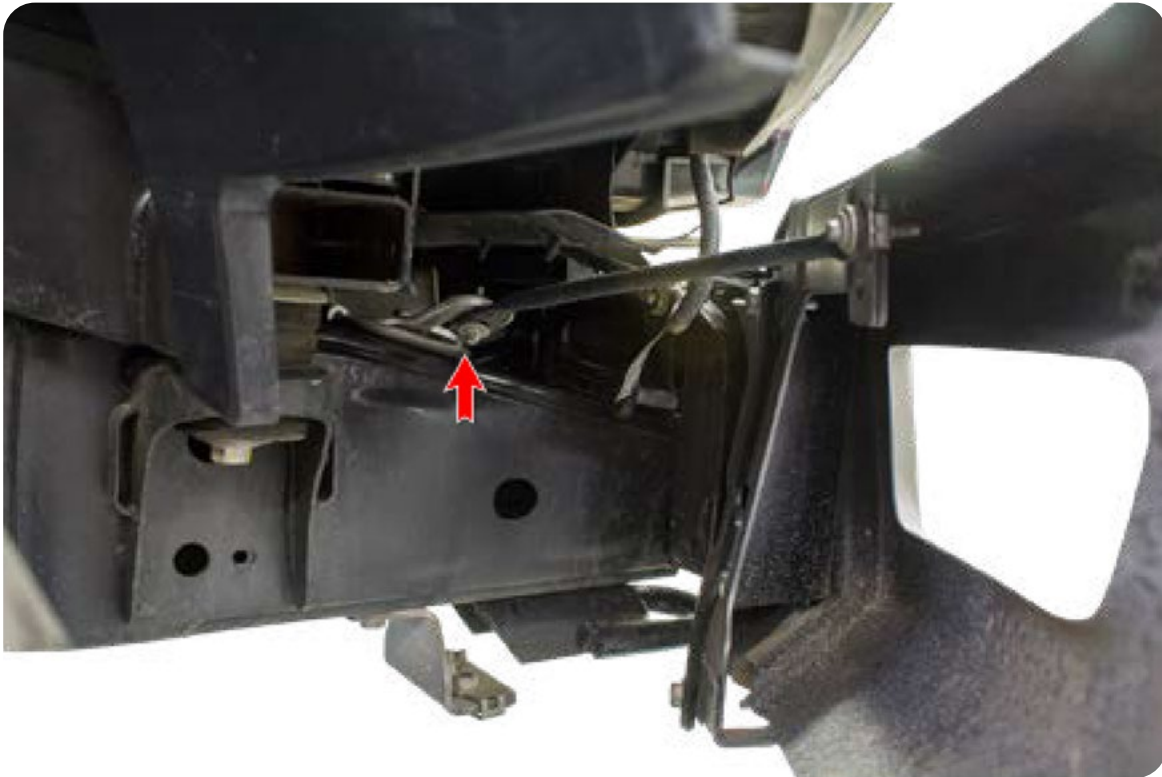

EDGE FRONT BUMPER 2021-UP/FORD F-150 RAPTOR

REMOVAL

□ STEP 4

Unplug the main wiring harness plug located on the passenger side by pulling the gray tab back as shown below.

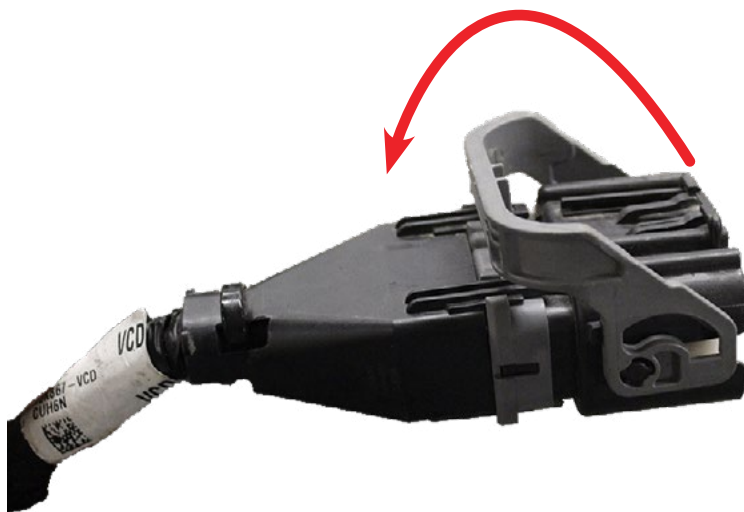
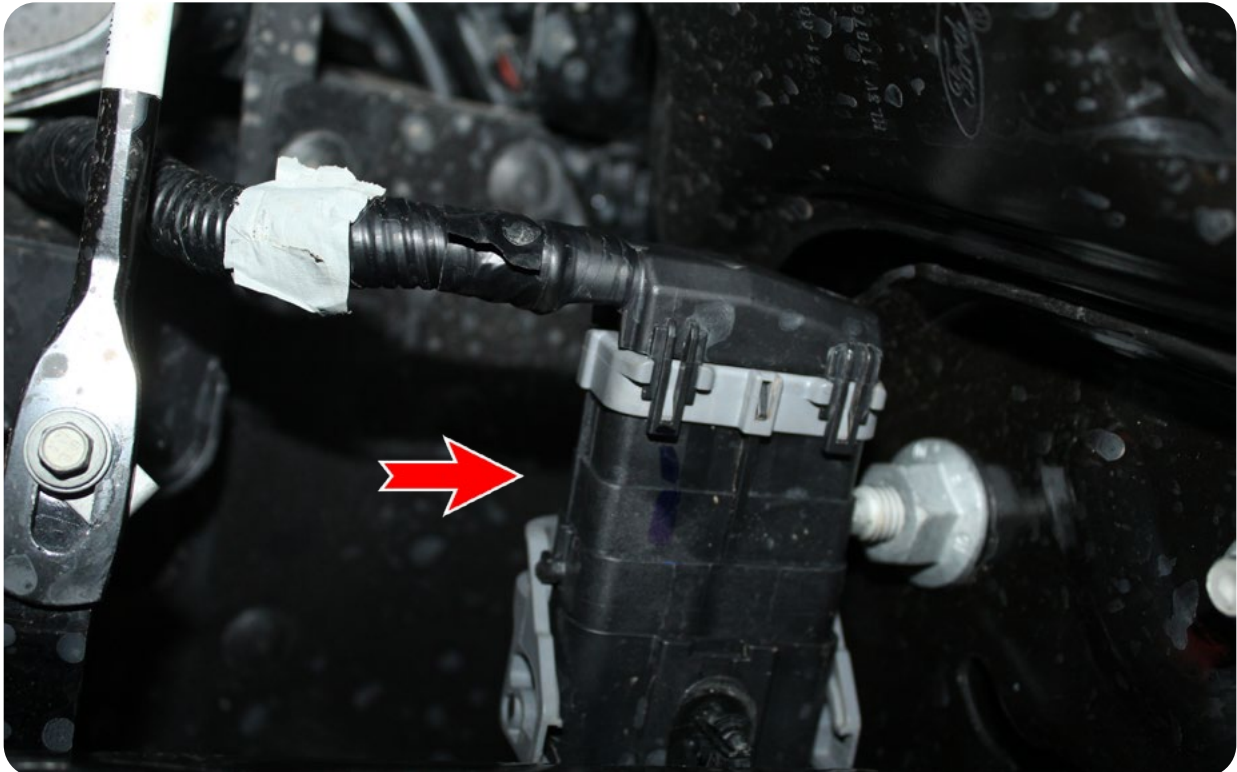

EDGE FRONT BUMPER 2021-UP/FORD F-150 RAPTOR

REMOVAL

□ STEP 5

Remove the mounting bolts located on the frame horn using a (21mm Socket). (Repeat on other side)

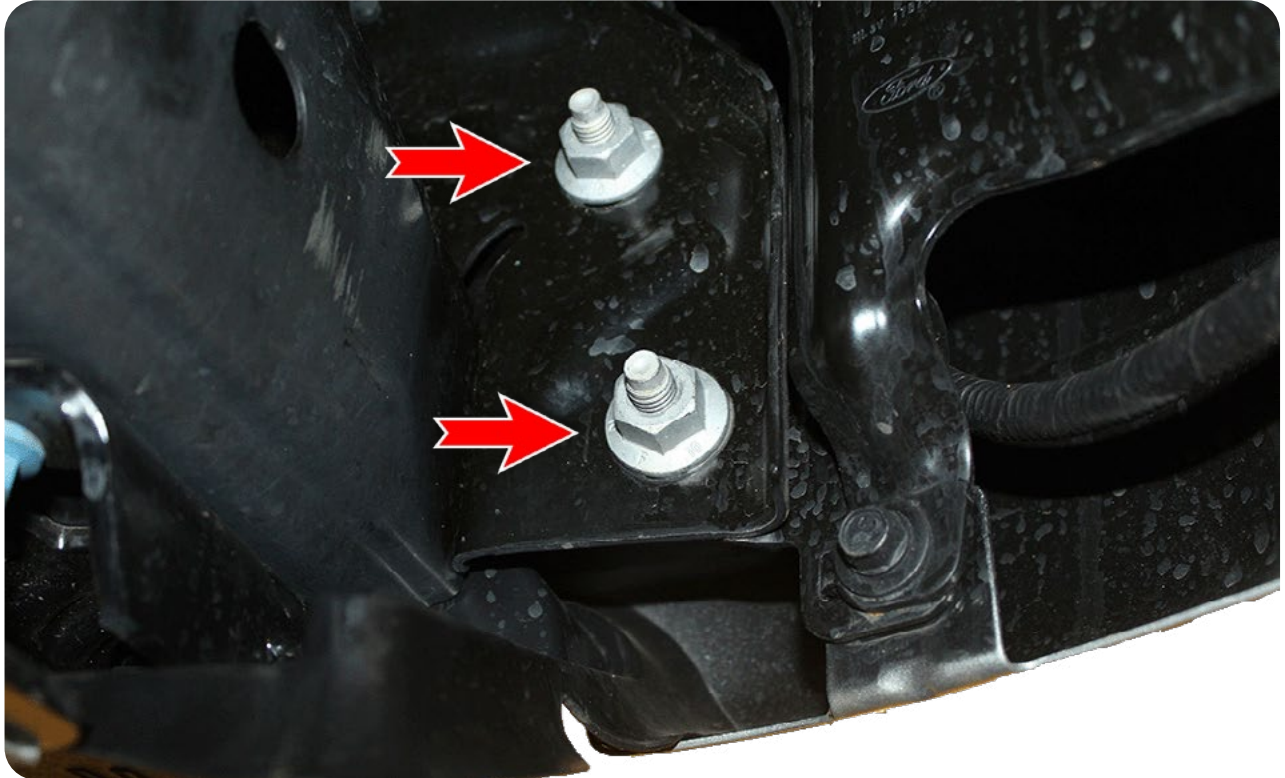

EDGE FRONT BUMPER 2021-UP/FORD F-150 RAPTOR

REMOVAL

□ STEP 6

- Remove the inter cooler guard bolts by using a (10mm socket) and remove the shutter motor from the guard. Zip tie the shutter motor to the wiring harness once it is installed on your ADD bumper.
- If you have a **2024 F-150 Raptor**, Follow the install guide for the Shutter Motor Bracket.
https://www.addictivedesertdesigns.com/cdn/shop/files/ADD_InstallGuide_AC1300900NA.pdf?v=4894805209185784070

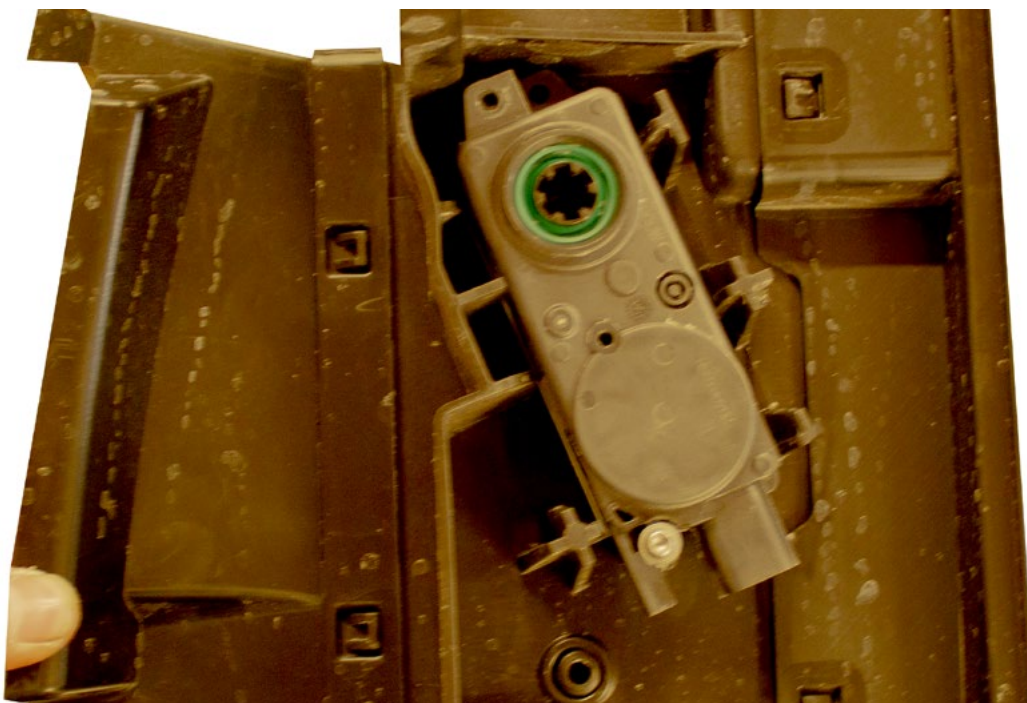

EDGE FRONT BUMPER 2021-UP/FORD F-150 RAPTOR

REMOVAL

□ STEP 7

Remove the tow hooks and the skid plate mount by using a (15mm socket) and a (13mm socket).

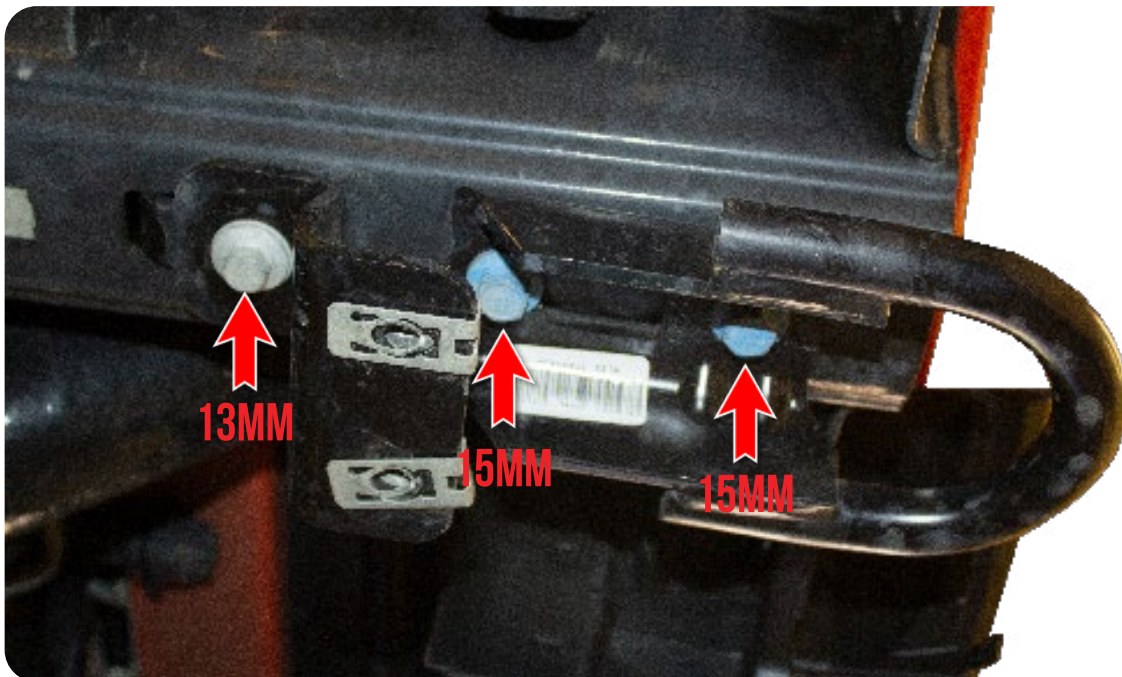
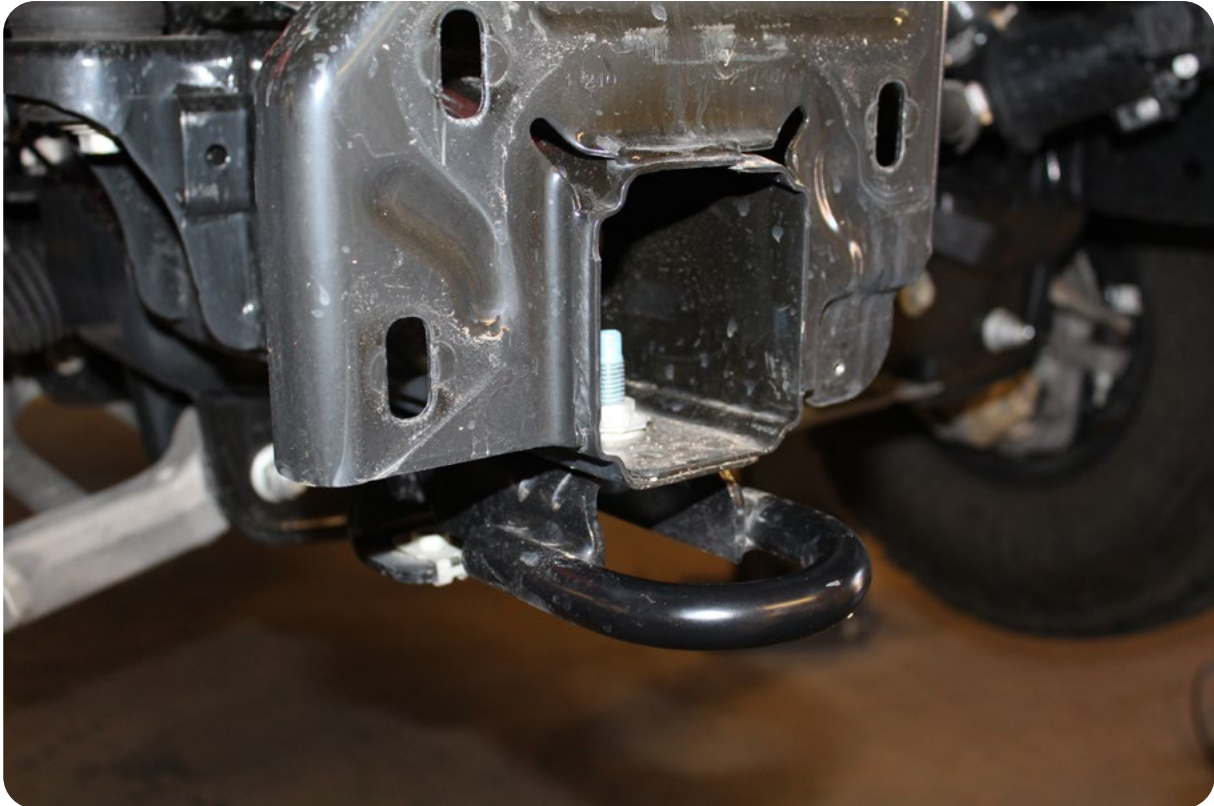



EDGE FRONT BUMPER 2021-UP/FORD F-150 RAPTOR

REMOVAL

□ STEP 8

Remove the OEM nut clips for the skid plate bottom mounts and replace with the provided (E) 3/8" nut clips.

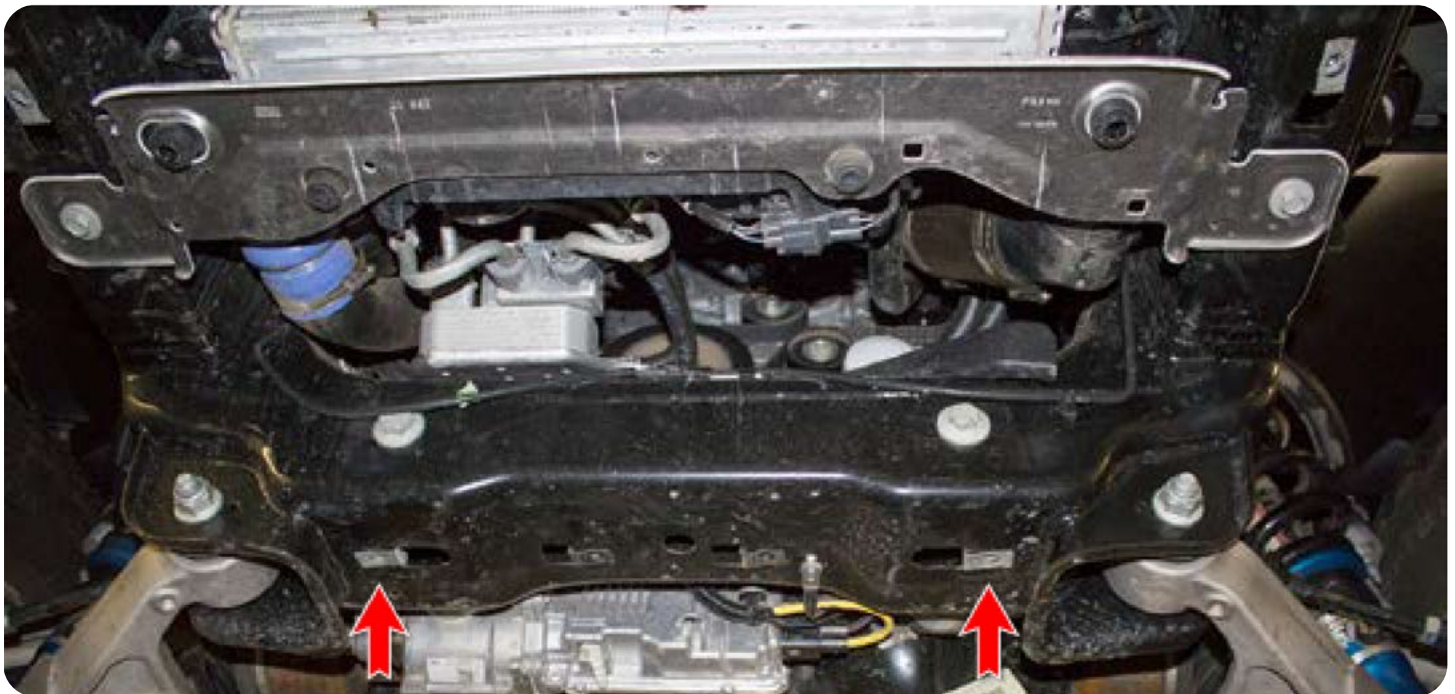

EDGE FRONT BUMPER 2021-UP/FORD F-150 RAPTOR

REMOVAL

□ STEP 9

Using a (10mm socket), remove the covers to expose the wire harness.

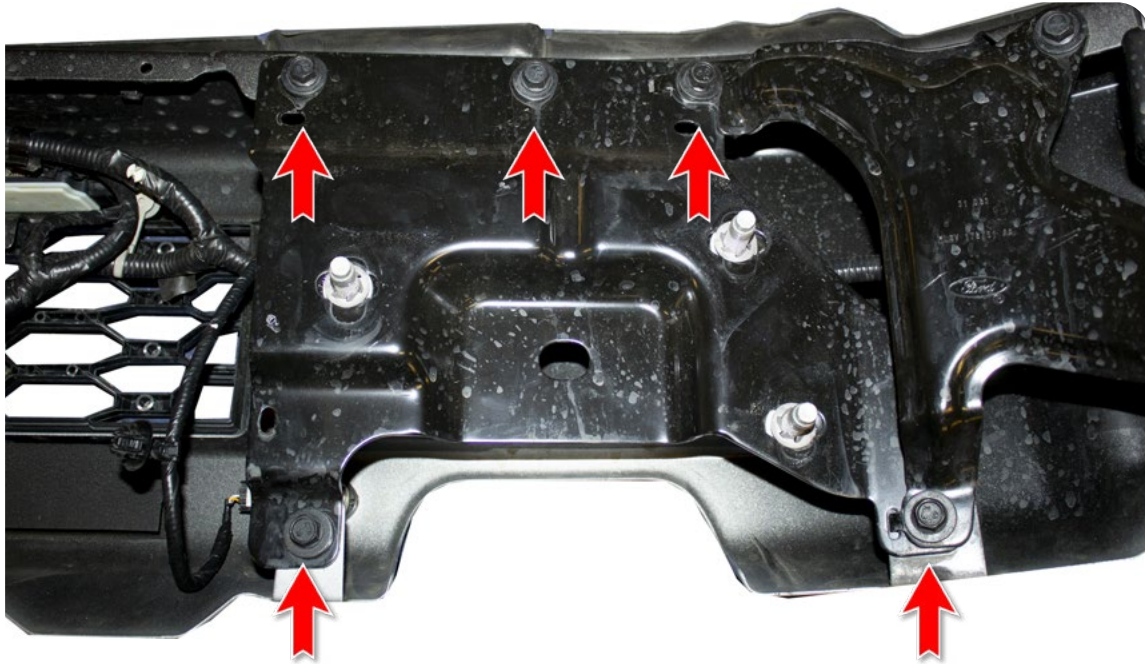



INSTALLATION GUIDE

EDGE FRONT BUMPER
2021-UP/FORD F-150 RAPTOR

REMOVAL



EDGE FRONT BUMPER 2021-UP/FORD F-150 RAPTOR

REMOVAL

□ STEP 10

Remove all four parking sensors and bezels from the stock bumper and remove wire harness.

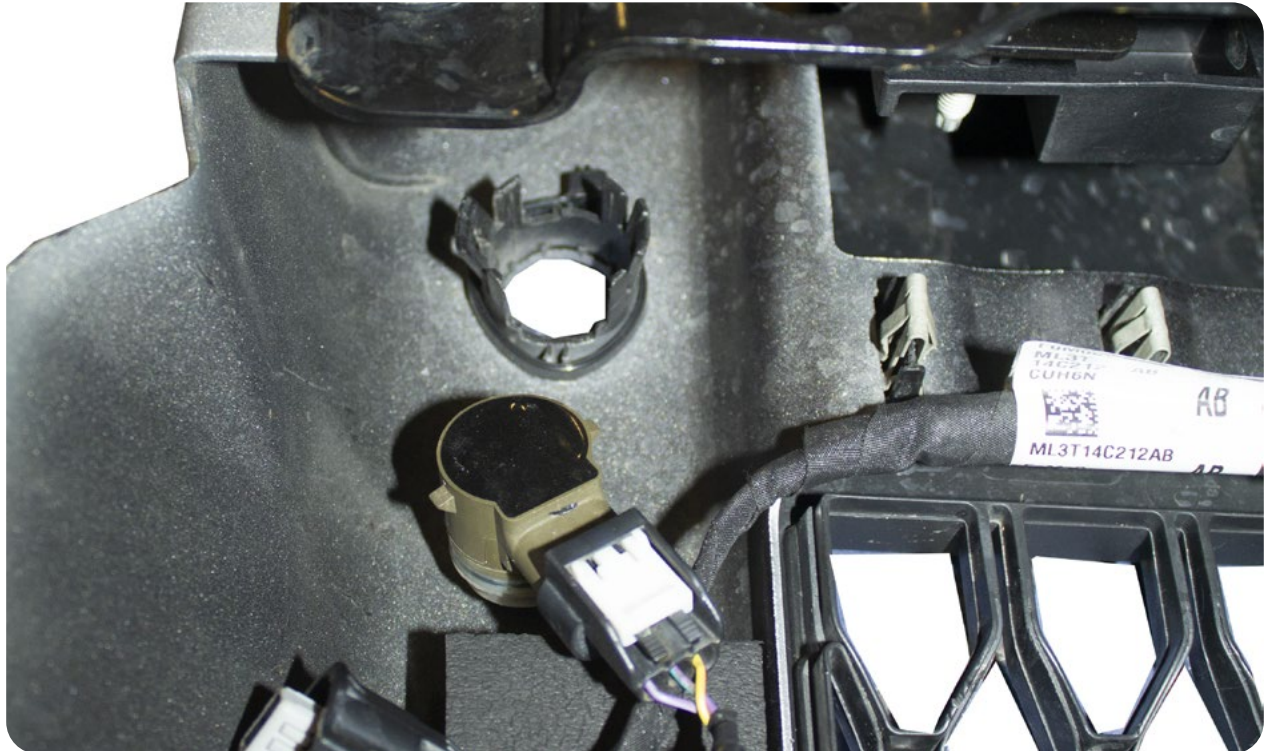

Spread these two tabs to release the sensor from its mounting ring.



EDGE FRONT BUMPER 2021-UP/FORD F-150 RAPTOR

INSTALL

□ STEP 11

Now would be a good time to install your light configuration. If you're installing Baja LP4's, Ensure to use the provided (D) fender washers as a spacer between the bumper and light bracket to center the light in the cutout.

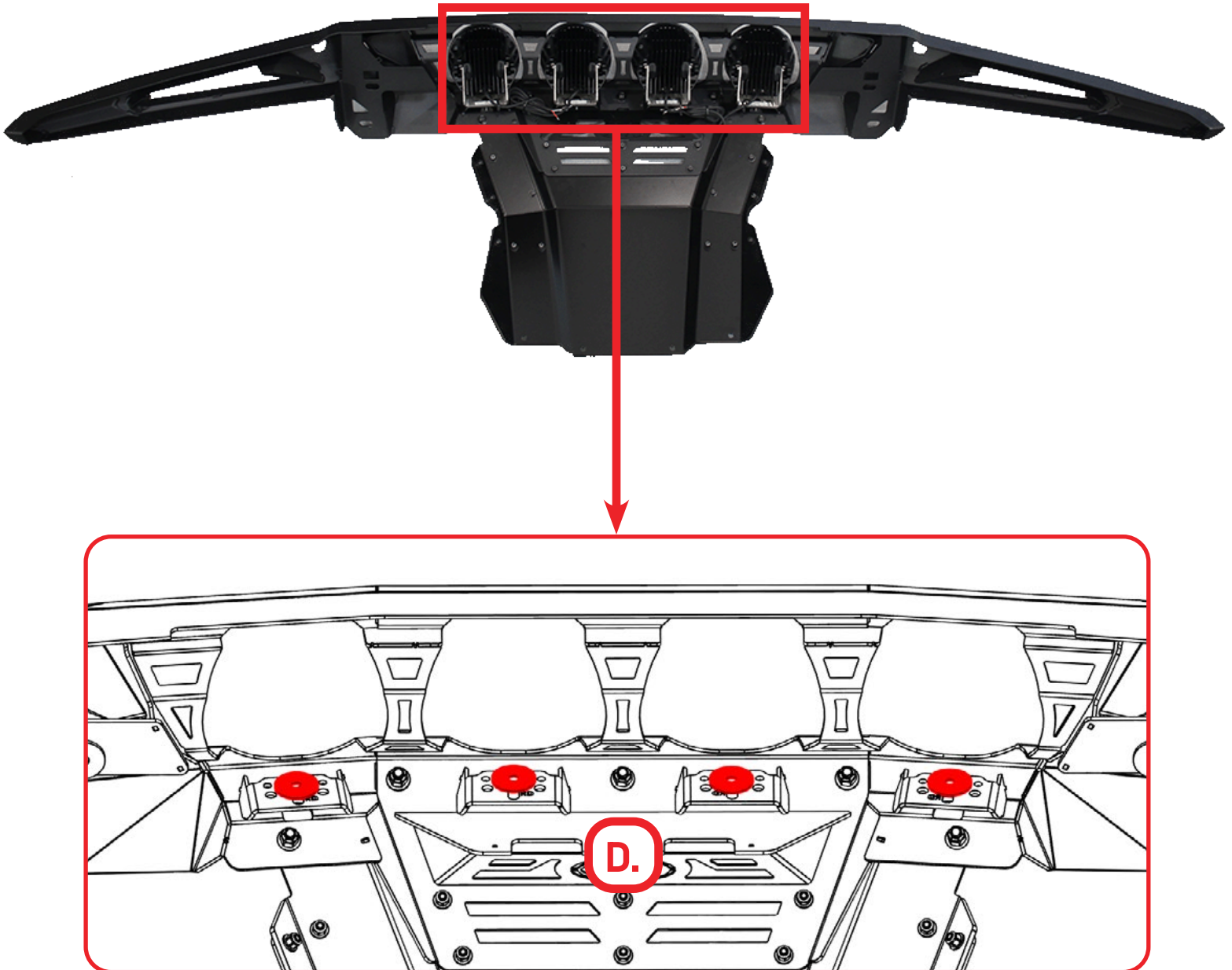



INSTALLATION GUIDE

EDGE FRONT BUMPER 2021-UP/FORD F-150 RAPTOR

INSTALL

□ STEP 12

Install the sensor bezels into the ADD bumper. ****If the bezels do not click into place you may have to trim the tabs to match the thickness of the bumper as shown below****

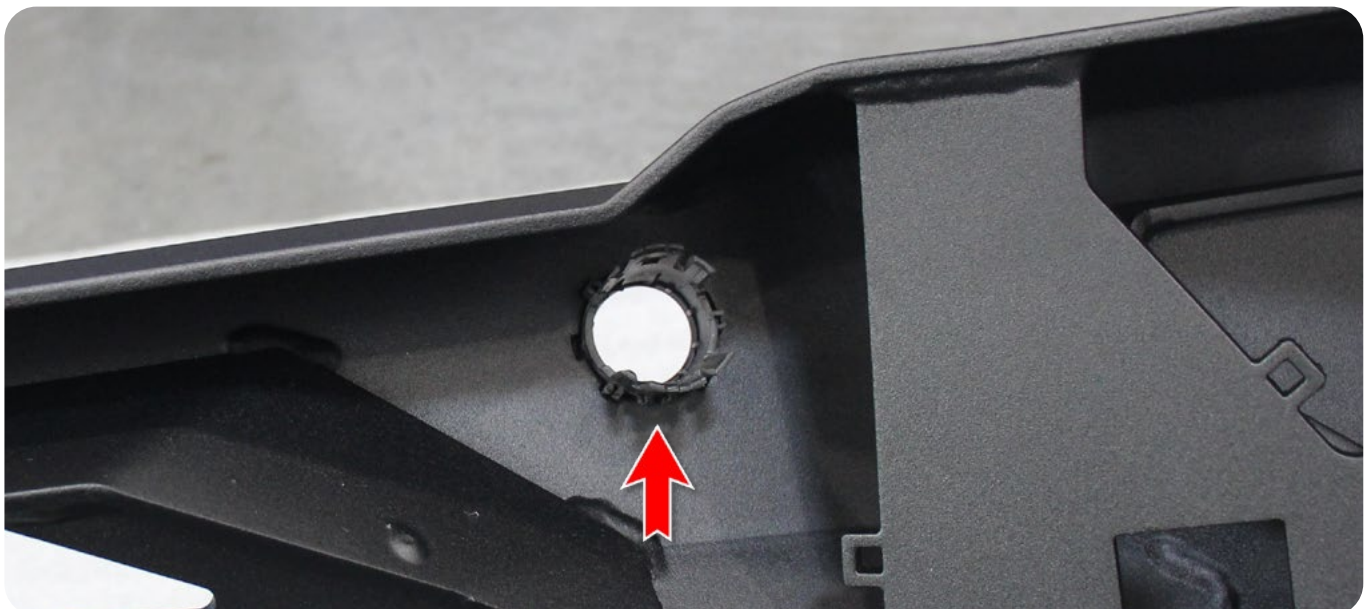
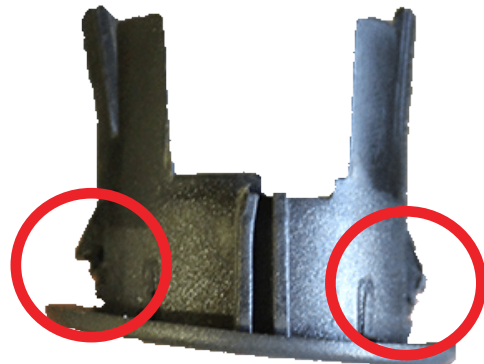
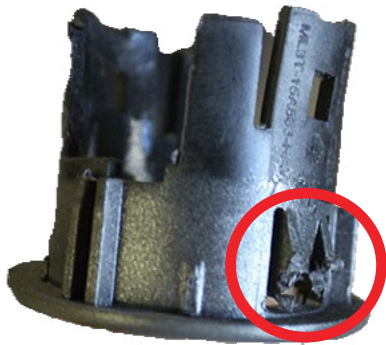

EDGE FRONT BUMPER 2021-UP/FORD F-150 RAPTOR

INSTALL

□ STEP 13

Passenger outer sensor orientation



EDGE FRONT BUMPER 2021-UP/FORD F-150 RAPTOR

INSTALL

□ STEP 14

Driver outer sensor orientation



EDGE FRONT BUMPER 2021-UP/FORD F-150 RAPTOR

INSTALL

□ STEP 15

Driver inner sensor orientation.



EDGE FRONT BUMPER 2021-UP/FORD F-150 RAPTOR

INSTALL

□ STEP 16

Passenger inner sensor orientation.





INSTALLATION GUIDE

EDGE FRONT BUMPER 2021-UP/FORD F-150 RAPTOR

INSTALL

□ STEP 17

Route the wiring harness underneath the lights and zip tie to the light mounts as shown below.

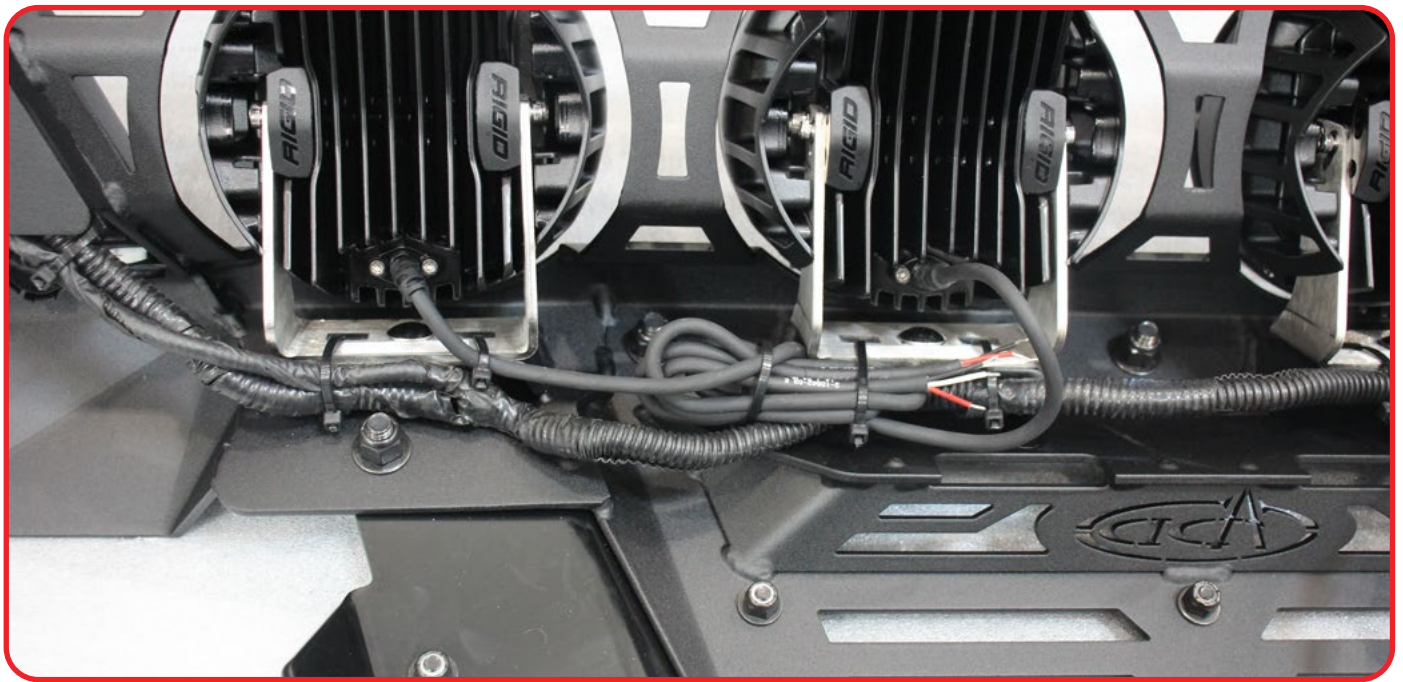



INSTALLATION GUIDE

EDGE FRONT BUMPER 2021-UP/FORD F-150 RAPTOR

INSTALL

STEP 18

Install the skid plate mounting bracket with the provided (A, C1, C2) 3/8" hardware using a (9/16 wrench) and a (7/32 allen).

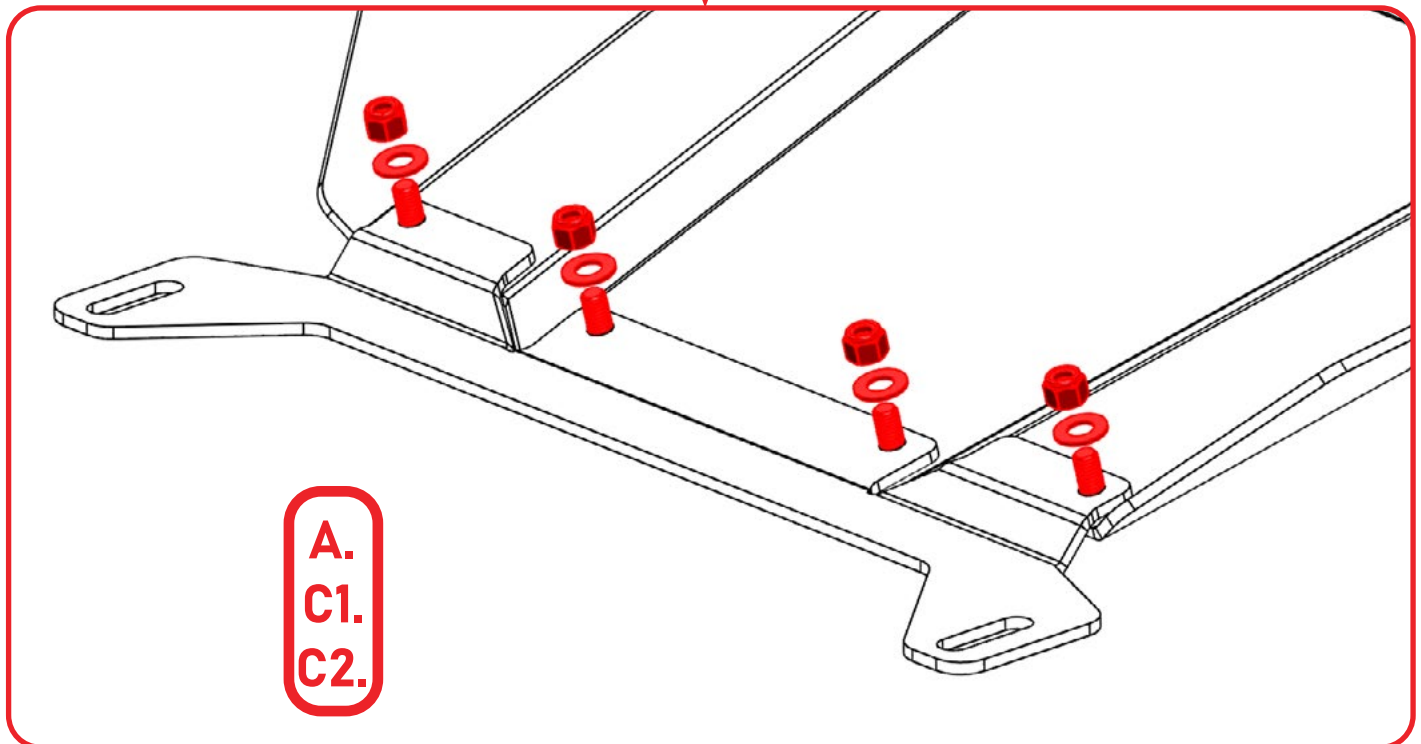



INSTALLATION GUIDE

EDGE FRONT BUMPER 2021-UP/FORD F-150 RAPTOR

INSTALL

□ STEP 19

Install the provided (E) 3/8" U-Nut.

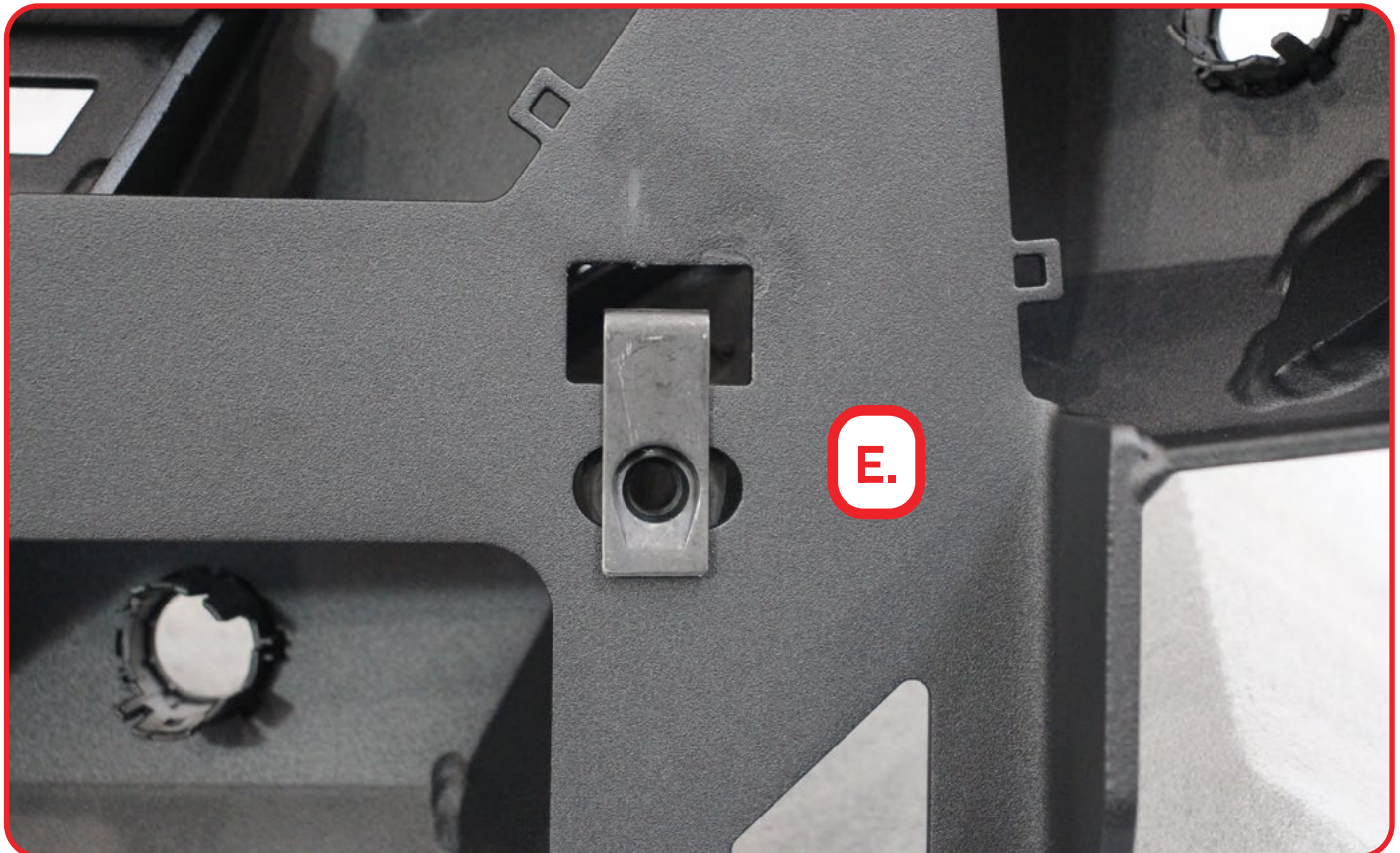



INSTALLATION GUIDE

EDGE FRONT BUMPER 2021-UP/FORD F-150 RAPTOR

INSTALL

□ STEP 20

With a helping hand, install the bumper with the provided **(B, D)** 3/8" Hardware using a (9/16 socket).

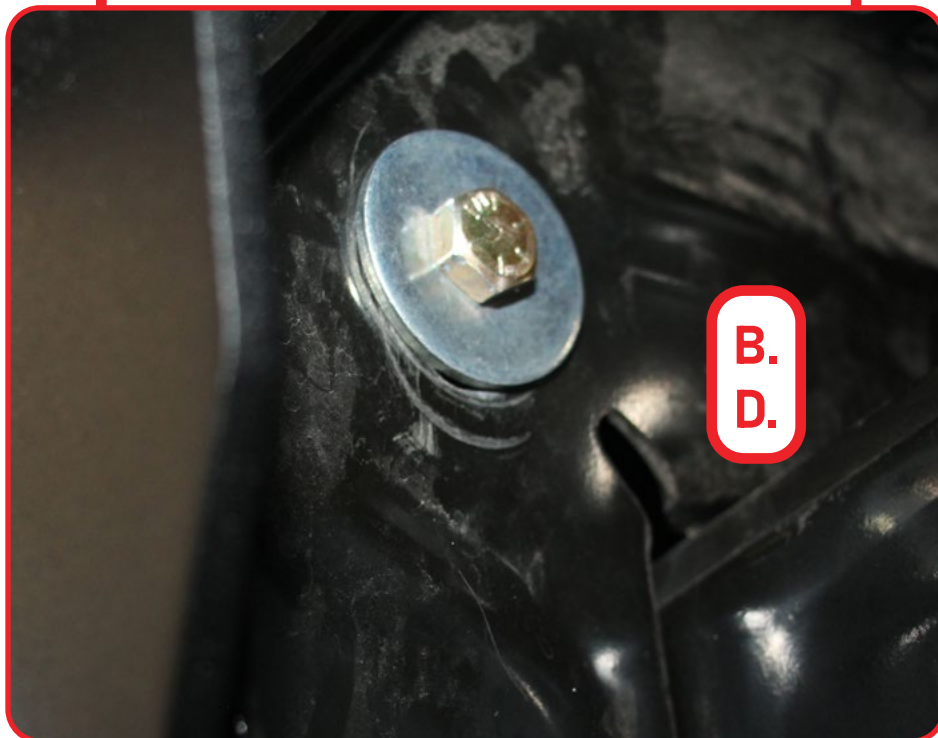



INSTALLATION GUIDE

EDGE FRONT BUMPER 2021-UP/FORD F-150 RAPTOR

INSTALL

□ STEP 21

Install the provided **(F, F1, F2)** 1/2" hardware using a (3/4" wrench) and a (5/16 allen).





INSTALLATION GUIDE

EDGE FRONT BUMPER 2021-UP/FORD F-150 RAPTOR

INSTALL

□ STEP 22

If you are not happy with the fitment on the sides, Refer to the next page for shimming notes. Install the provided **(D)** 3/8" fender washer between the bumper and frame horn to bring the pitch up. Install the provided **(F1)** 1/2" washer between the bumper and frame horn to bring the pitch down.





INSTALLATION GUIDE

EDGE FRONT BUMPER
2021-UP/FORD F-150 RAPTOR

INSTALL



PITCH UP

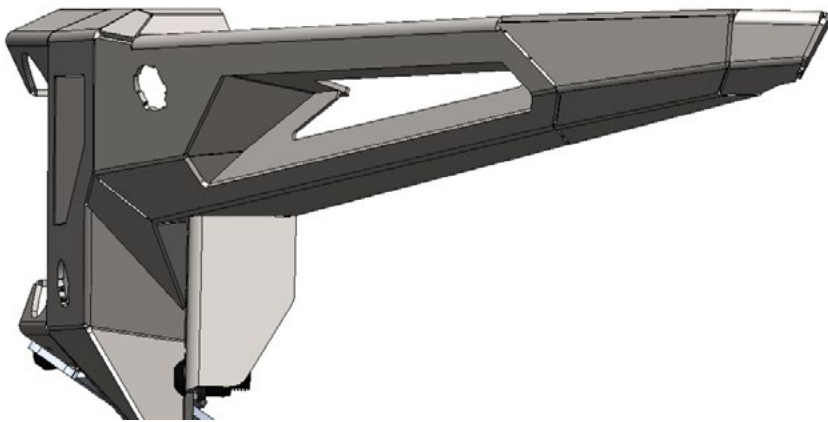

PITCH DOWN

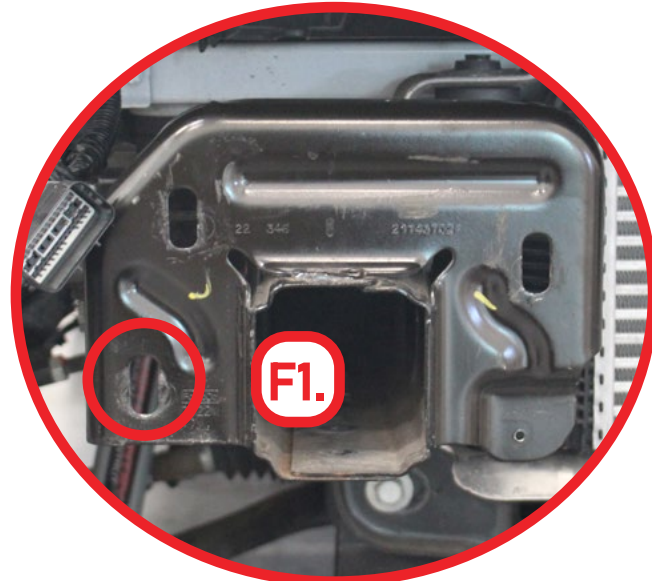
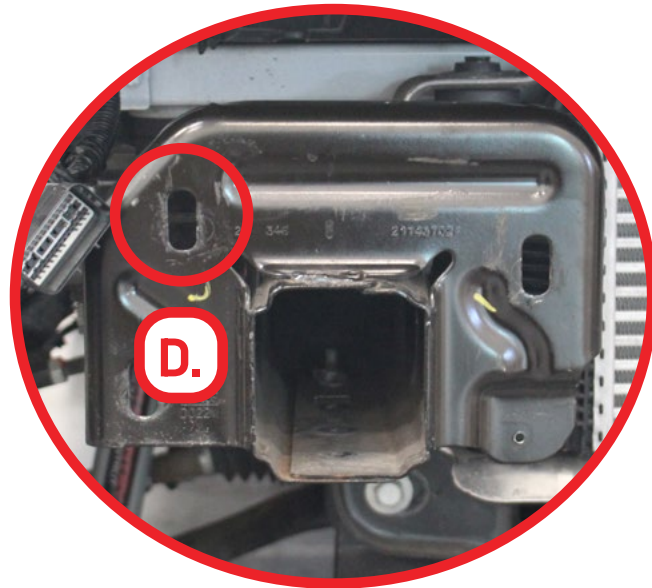
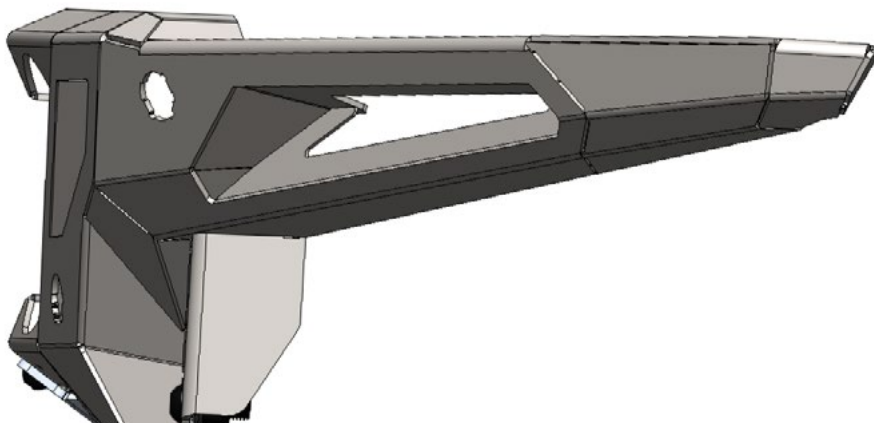

EDGE FRONT BUMPER 2021-UP/FORD F-150 RAPTOR

INSTALL

STEP 23

Install the hardware removed from step 1.



EDGE FRONT BUMPER 2021-UP/FORD F-150 RAPTOR

INSTALL

□ STEP 24

Plug in the wire harness. ****Ensure the clip is fully pushed down when plugged in as shown below****

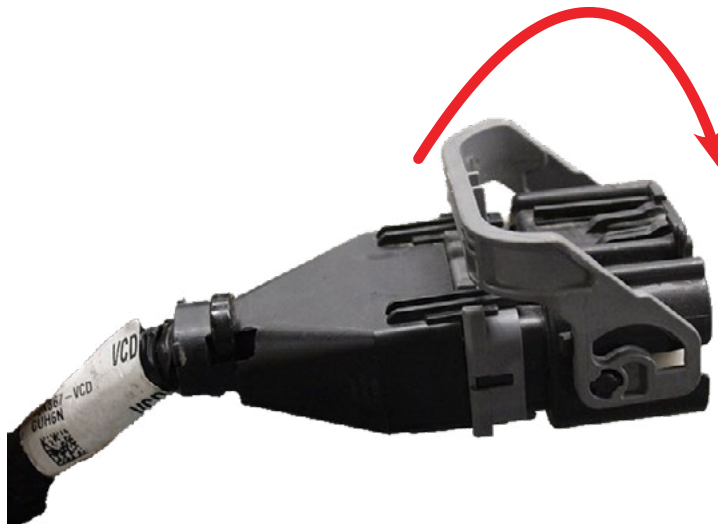
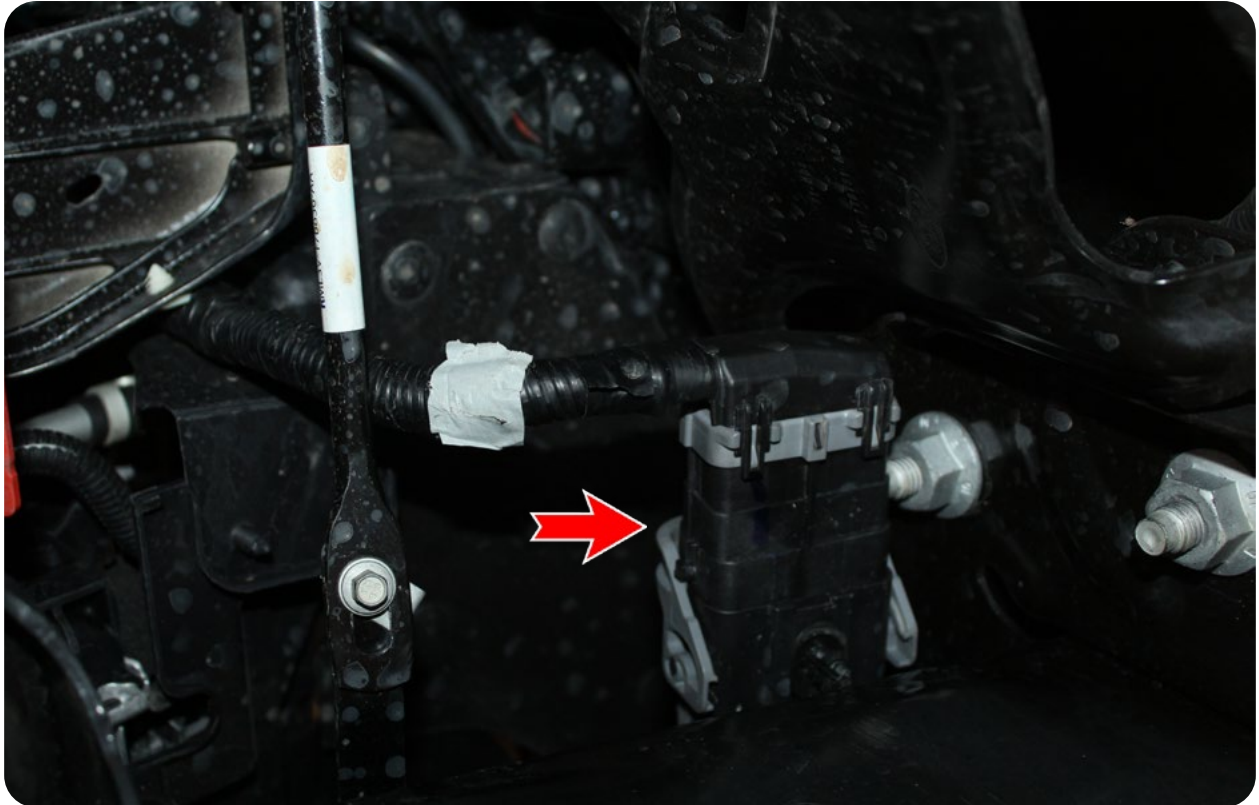



INSTALLATION GUIDE

EDGE FRONT BUMPER 2021-UP/FORD F-150 RAPTOR

FINAL

STEP 25

Stand back and enjoy your new ADD Edge Front Bumper.

Check and re-tighten all mounting bolts after 100 miles and periodically thereafter.



THIS PRODUCT IS PROTECTED BY ONE OR MORE U.S. PATENTS
WWW.ADDICTIVEDESERTDESIGNS.COM/PATENTS

FOR ADDITIONAL SUPPORT OR TECHNICAL QUESTIONS,
PLEASE CALL 480-671-0820 OR
EMAIL INFO@ADDICTIVEDESERTDESIGNS.COM