

7929 Lincoln Ave. Riverside, CA 92504
Phone: 951.689.ICON | Fax: 951.689.1016

PART #	DESCRIPTION
91001	F-SERIES BILLET SHACKLE KIT

COMPONENTS INCLUDED	
(2) 194048 F-SERIES BILLET SHACKLE W/ BUSHING	
HARDWARE INCLUDED	
N/A	
TOOLS REQUIRED	
FLOOR JACK JACK STANDS RATCHET IMPACT	TORQUE WRENCH 21MM SOCKET / WRENCH 24MM SOCKET / WRENCH
TECH NOTES	
<p>1. WORKS WITH 2010 AND NEWER F150 AND F250 TRUCKS, INCLUDING RAPTORS WITH LEAF SPRINGS.</p> <p>2. PROVIDES 1" OF DROP.</p> <p>3. ESTIMATED INSTALL TIME: 2 HOURS</p>	



WARNING!

**** READ ALL INSTRUCTIONS THOROUGHLY FROM START TO FINISH BEFORE BEGINNING INSTALLATION! IF THESE INSTRUCTIONS ARE NOT PROPERLY FOLLOWED SEVERE FRAME, SUSPENSION AND TIRE DAMAGE MAY RESULT TO THE VEHICLE!**

**** ICON VEHICLE DYNAMICS RECOMMENDS THAT YOU EXERCISE EXTREME CAUTION WHEN WORKING UNDER A VEHICLE THAT IS SUPPORTED WITH JACK STANDS.**

**** ICON VEHICLE DYNAMICS RECOMMENDS ALL INSTALLATION TO BE PERFORMED BY A PROFESSIONAL SHOP/SERVICE TECHNICIAN. PRODUCT FAILURE CAUSED BY IMPROPER INSTALLATION WILL NOT BE COVERED UNDER ICON'S WARRANTY POLICY.**

INSTALLATION

- Place the truck on a flat surface with the parking brake engaged, chock the front tires.
- Use a suitable floor jack in the manufacturer designated spot on the frame to lift the rear of the truck, then place a suitable jack stand under the frame and set the truck down securely on the jack stand. NEVER WORK UNDER AN UNSUPPORTED VEHICLE. Remove the rear wheels and tires.
- Use the floor jack to support the rear axle.
- Use a 24mm to loosen and remove the nut holding the stock shackle to the frame mount. Some models, it's a 21mm for the bolt and the nut is captured inside the mount.
- With the bolt removed, you will need to jack up the axle so you can loosen and remove the bolt that holds the shackle to the leaf spring. A 24mm will loosen the nut while a 21mm can hold the bolt from spinning. Slide the bolt out and remove the shackle.
- Install the new ICON billet shackle as shown and install the OEM bolts in the same manner they were removed. The upper bolt will need to be installed prior to fitting the shackle into the frame mount. [FIGURE 1 & 2]

FIG.1

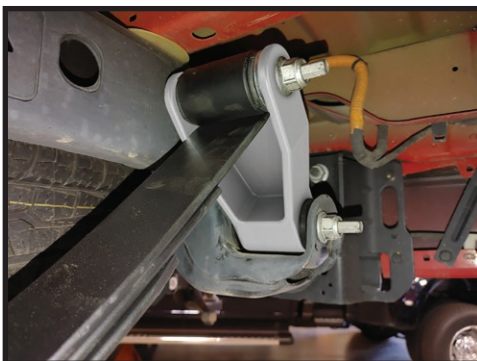

FIG.2



7. With both shackles installed, install the wheels and tires and lower the truck to the ground. Once on the ground, the bolts can be torqued to 175 ft-lbs.

NOTE: If the bolts are torqued with the suspension drooped out, it will cause premature wear and possible bushing failure.

VERIFY ALL FASTENERS ARE PROPERLY TORQUED BEFORE DRIVING VEHICLE.

RETORQUE ALL NUTS, BOLTS AND LUGS AFTER 100 MILES AND PERIODICALLY THEREAFTER.

ICON VEHICLE DYNAMICS LIMITED LIFETIME WARRANTY

ICON Vehicle Dynamics warrants to the original retail purchaser who owns the vehicle on which the product was originally installed. ICON Vehicle Dynamics does not warrant the product for finish, alterations, modifications and/or installation contrary to ICON Vehicle Dynamics instructions. ICON Vehicle Dynamics products are not designed, nor are they intended to be installed on vehicles used in race applications, for racing purposes or for similar activities. (A "race" is defined as any contest between two or more vehicles, or a contest of one or more vehicles against the clock, whether or not such contest is for a prize). This warranty does not include coverage for police or taxi vehicles, race vehicles, or vehicles used for government or commercial purposes. Also excluded from this warranty are sales outside of the United States of America and Canada.

ICON Vehicle Dynamics' obligation under this warranty is limited to the repair or replacement, at ICON Vehicle Dynamics' discretion, of the defective product. Any and all costs of removal, installation or re-installation, freight charges and incidental or consequential damages are expressly excluded from this warranty. Items that are subject to wear are not considered defective when worn and are not covered.

ICON Vehicle Dynamics components must be installed as a complete kit as shown in our current application guide. Any substitutions or exemptions of required components will immediately void the warranty. Some finish damage may happen to parts during shipping and is not covered under warranty.

This warranty is expressly in lieu of all other warranties expressed or implied. This warranty shall not apply to any product that has been improperly installed, modified or customized subject to accident, negligence, abuse or misuse.



ICON VEHICLE DYNAMICS®
PERFORMANCE SUSPENSION SYSTEMS AND SHOCK ABSORBERS

7929 Lincoln Ave. Riverside, CA 92504 Phone: 951.689.ICON Fax: 951.689.1016
www.iconvehicledynamics.com



FOLLOW US ON FACEBOOK!



7929 Lincoln Ave. Riverside, CA 92504
 Phone: 951.689.ICON | Fax: 951.689.1016

PART #	DESCRIPTION
91824	21-UP F150 TREMOR 2-3" 2.5 VS RR COILOVER KIT

COMPONENTS INCLUDED

(1) 194800RD 21-UP F150 TREMOR 2-3" 2.5 CO RR UPKG DRIV	(1) 194800RP 21-UP F150 TREMOR 2-3" 2.5 CO RR UPKG PASS
---	---

HARDWARE INCLUDED

(2) 250005 RESI BRACKETS	(2) 605144 3/8-12 X .750" FLANGED SELF-TAP BOLT
(2) 605131 3/8" SPLIT LOCK WASHER	(1) 611051 #36 HOSE CLAMPS (4)

611019 HARDWARE KIT

(6) 605101 3/8"-16 X 1.00" HHCS	(6) 605131 3/8" SPLIT LOCK WASHER
---------------------------------	-----------------------------------

611052 HARDWARE KIT

(4) 605205 7/16"-14 X 2.75" HHCS	(4) 605231 WASHER-1.00" X 0.469" X 0.125"
(4) 605230 7/16" SAE FLAT WASHER	

TOOLS REQUIRED

JACK JACK STANDS TORQUE WRENCH 8MM SOCKET / WRENCH 10MM SOCKET / WRENCH 18MM SOCKET / WRENCH	21MM SOCKET / WRENCH 27MM SOCKET / WRENCH 5/16" SOCKET / WRENCH 9/16" SOCKET / WRENCH 5/8" SOCKET / WRENCH
---	--

TECH NOTES

1. ESTIMATED INSTALL TIME: 2-3 HOURS.
2. YOUR ICON COILOVER ASSEMBLIES COME FACTORY CHARGED TO 250 PSI. RELEASING NITROGEN PRESSURE MAY LEAD TO SHOCK MALFUNCTION AND REDUCED RIDE QUALITY. FAILURE CAUSED BY LOW NITROGEN PRESSURE IS NOT COVERED UNDER ICON'S WARRANTY POLICY.
3. MUST BE USED WITH ICON UCA 98522DJ OR 98523DJ.
4. FOR TREMOR EQUIPPED TRUCKS ONLY.
5. THE SHOCKS SHIP AT ICON'S RECOMMENDED RIDE HEIGHT. ICON DOES NOT RECOMMEND ADJUSTING THE COIL BEYOND 1.75" OF THREADS BETWEEN THE BOTTOM OF THE TOP CAP AND THE TOP OF THE COIL NUT. ADJUSTING BEYOND 1.75" OF THREAD SHOWING WILL REDUCE RIDE QUALITY. DO NOT EXCEED 2.5" OF EXPOSED THREADS.



WARNING!

**** READ ALL INSTRUCTIONS THOROUGHLY FROM START TO FINISH BEFORE BEGINNING INSTALLATION! IF THESE INSTRUCTIONS ARE NOT PROPERLY FOLLOWED SEVERE FRAME, SUSPENSION AND TIRE DAMAGE MAY RESULT TO THE VEHICLE!**

**** ICON VEHICLE DYNAMICS RECOMMENDS THAT YOU EXERCISE EXTREME CAUTION WHEN WORKING UNDER A VEHICLE THAT IS SUPPORTED WITH JACK STANDS.**

**** ICON VEHICLE DYNAMICS RECOMMENDS ALL INSTALLATION TO BE PERFORMED BY A PROFESSIONAL SHOP/SERVICE TECHNICIAN. PRODUCT FAILURE CAUSED BY IMPROPER INSTALLATION WILL NOT BE COVERED UNDER ICON'S WARRANTY POLICY.**

4. Remove the 2 nuts from the lower shock mount using an 18mm socket/wrench. [FIGURE 2]

INSTALLATION

1. Using a properly rated jack, raise the front of the vehicle and support the frame rails with jack stands. Ensure the jack stands are secure and set properly before lowering the jack. NEVER WORK UNDER AN UNSUPPORTED VEHICLE. Remove the front wheels/tires.
2. Disconnect the tie rod from the spindle using a 21mm and 10mm wrench.
3. Disconnect the sway bar link from spindle using a 21mm and T45 torx wrench. [FIGURE 1]

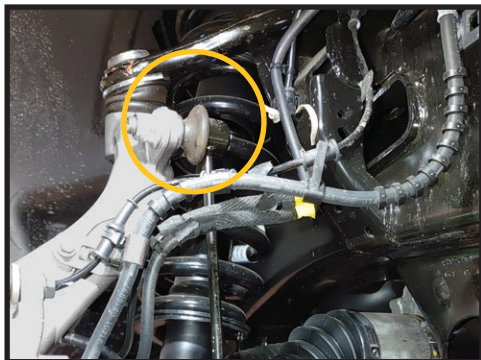

FIG.1



FIG.2

5. Support the spindle with a jack or strap and remove the lower control arm bolts from the frame using a 27 and 21mm socket/wrench. This will allow you to separate the lower arm and lower shock studs. **[FIGURE 3]**

FIG.3



If you prefer to leave the lower arm in place, use a hammer to push the studs out of the lower bar pin assembly.

6. Remove the 3 nuts from the top of the factory shock assembly with an 18mm socket/wrench. The coilover can then be removed completely. **[FIGURE 4]**

FIG.4



7. If the Lower arm was removed, re-install it at this time. Do not torque the pivot bolts until the truck is sitting on its own weight.

8. Using a hammer or a ball joint separator, separate the taper from the spindle. Remove the nut and disconnect the UCA from the spindle. if applicable, refer to ICON Delta Joint Upper Control Arm installation instruction at this time.

9. Install ICON coil-over assembly now, using supplied 3/8" bolts (605101) and washers (605131) using a 9/16" socket/wrench [Torque to 30 ft-lbs]. The top cap fitting points out, away from the frame. **[FIGURE 5]**

FIG.5



10. Use the supplied 7/16" bolts and washers to secure the ICON coil-over to the lower arm using a 5/8" wrench/socket. [Torque to 50 ft-lbs] The bar pin is installed to offset the shock forward to increase axle clearance. Each 7/16" bolt will get 2 washers, the thicker black oxide washer will go against the Lower control arm, while the thinner yellow zinc washer will go against the head of the bolt. [FIGURE 6 & 7]

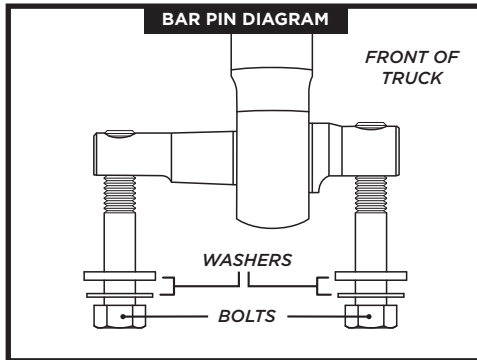

FIG.6



FIG.7

11. Connect the upper control arm to the knuckle using an 18mm socket/wrench. [Torque OEM balljoint to factory spec] [75 ft-lbs for the ICON DELTA JOINT]

12. Connect the tie rod to the spindle using a 21mm and 10mm wrench. [Torque to factory spec]

13. Connect the swaybar link to the spindle using a 21mm and T45 torx wrench.

14. Hold the Reservoir bracket in position as shown. Mark and center punch the bolt hole location. Use a 11/32" drill bit and drill the hole. Then use supplied self-tapping bolt (605144) with lock washer (605131) to mount the reservoir bracket using a 9/16" socket/wrench. [FIGURE 8]

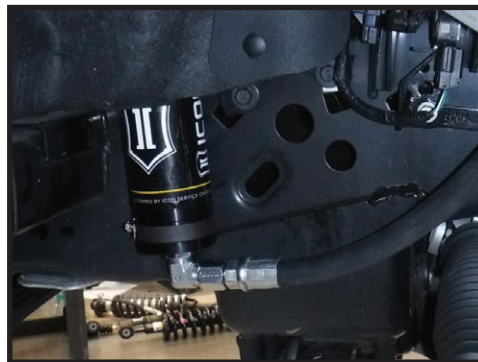

FIG.8

15. Mount the reservoir to the bracket using supplied hose clamps and a flat head screw driver or 5/16" socket/wrench.

16. Repeat steps for passenger side.

17. Install Wheels and lower vehicle to the ground. [Torque to factory spec]

18. If the lower arms were removed from the frame pivots, tighten the bolts now. [Torque to factory spec]

19. Have the truck professionally aligned.

VERIFY ALL FASTENERS ARE PROPERLY TORQUED BEFORE DRIVING VEHICLE.

RETORQUE ALL NUTS, BOLTS AND LUGS AFTER 100 MILES AND PERIODICALLY THEREAFTER.

2.5 VS SERIES SHOCK & COILOVER TECHNICAL INFORMATION

MAINTENANCE

ICON shock absorbers are a high quality rebuildable race style shock absorber designed for optimal performance. With a unit of this caliber on your vehicle, routine maintenance is required to keep them looking and operating in like new condition. Residual oil and assembly lube may be present at all seal paths from the factory out of the box and is considered normal. Pooling of oil however is not acceptable at any time and one should contact the ICON dealer where purchased.

BELOW ARE GUIDELINES BASED ON HOW YOU USE YOUR VEHICLE BUT YOUR MILEAGE MAY VARY:

STREET USE:

- Send in for factory servicing every 40,000 miles or if a leak develops, ride quality decreases, or they begin to make excessive noise.
- Remove any buildup of road salt, mud, or debris from shocks and coil springs anytime accrued
- Clean with mild soap and water with each oil change or anytime you notice build up.
- Wax the cylinders yearly with automotive wax to prevent corrosion.
- Check nitrogen pressure yearly. (252004 charge needle assembly available at any ICON distributor)
- Check bearings for excessive wear yearly.
- DO NOT apply any type of lube to the upper and lower bearings.

STREET/DIRT:

- Send in for factory servicing every 15,000 miles or if a leak develops, ride quality decreases, or they begin to make excessive noise.
- Clean with mild soap and water with each oil change, offroad trip, or anytime you notice build up.
- Wax the cylinders yearly with automotive wax to prevent corrosion.
- Check nitrogen pressure each dirt outing. (252004 charge needle assembly available at any ICON distributor)
- Check bearings for excessive wear yearly.
- DO NOT apply any type of lube to the upper and lower bearings.

DIRT USE:

- Send in for factory servicing every 1,000 miles.
- Check nitrogen pressure each outing. (252004 charge needle assembly available at any ICON distributor)
- Remove any buildup of mud or debris from shocks and coil springs after every outing.

SELF-SERVICE:

- Contact ICON for service kits & tools at (951) 689-4266.

PRODUCT REGISTRATION

Please visit: <http://www.iconvehicledynamics.com/tech-support/registration/> to register your product.

ICON VEHICLE DYNAMICS SHOCK ABSORBER WARRANTY

This shock absorber has a 1 year warranty against any manufacturer's defects. If a shock fails within the initial year of ownership, the shock must be shipped to ICON Vehicle Dynamics for inspection and service. If a shock is inspected and it has been determined the shock failed due to neglect, damage caused by improper installation or any other reason besides "normal wear and tear", the owner of said shock is responsible for all service costs. This includes labor, parts, and shipping.

ICON Vehicle Dynamics warrants to the original retail purchaser who owns the vehicle on which the product was originally installed. ICON Vehicle Dynamics does not warrant the product for finish, alterations, modifications and/or installation contrary to ICON Vehicle Dynamics instructions. ICON Vehicle Dynamics products are not designed, nor are they intended to be installed on vehicles used in race applications, for racing purposes or for similar activities. (A "race" is defined as any contest between two or more vehicles, or a contest of one or more vehicles against the clock, whether or not such contest is for a prize). This warranty does not include coverage for police or taxi vehicles, race vehicles, or vehicles used for government or commercial purposes. Also excluded from this warranty are sales outside of the United States of America and Canada.

ICON Vehicle Dynamics' obligation under this warranty is limited to the repair or replacement, at ICON Vehicle Dynamics' discretion, of the defective product. Any and all costs of removal, installation or re-installation, freight charges and incidental or consequential damages are expressly excluded from this warranty. Items that are subject to wear are not considered defective when worn and are not covered.

ICON Vehicle Dynamics components must be installed as a complete kit as shown in our current application guide. Any substitutions or exemptions of required components will immediately void the warranty. Some finish damage may happen to parts during shipping and is not covered under warranty.

This warranty is expressly in lieu of all other warranties expressed or implied. This warranty shall not apply to any product that has been improperly installed, modified or customized subject to accident, negligence, abuse or misuse.

To send a shock in for warranty please visit our website <http://www.iconvehicledynamics.com/tech-support/shock-service/>



ICON VEHICLE DYNAMICS®
PERFORMANCE SUSPENSION SYSTEMS AND SHOCK ABSORBERS

7929 Lincoln Ave. Riverside, CA 92504 Phone: 951.689.ICON Fax: 951.689.1016
www.iconvehicledynamics.com



FOLLOW US ON FACEBOOK!



7929 Lincoln Ave. Riverside, CA 92504
Phone: 951.689.ICON | Fax: 951.689.1016

PART #	DESCRIPTION
94000	21-23 F150 4WD FRONT KNUCKLE KIT

COMPONENTS INCLUDED	
(1) 197060D 21 F150 4WD LIFTED STEERING KNUCKLE DRVR	(1) 197060P 21 F150 4WD LIFTED STEERING KNUCKLE PASS
HARDWARE INCLUDED	
(1) 605969 VIBRATITE RED 2ML BULLET	
TOOLS REQUIRED	
JACK JACK STAND RATCHET EXTENSIONS TORQUE WRENCH HAMMER / DEADBLOW HAMMER BALL JOINT SEPERATOR	T45 TORX 5MM HEX KEY 8MM SOCKET / WRENCH 10MM SOCKET / WRENCH 13MM SOCKET / WRENCH 18MM SOCKET / WRENCH 21MM SOCKET / WRENCH 36MM SOCKET / WRENCH
TECH NOTES	
<ol style="list-style-type: none"> ESTIMATED INSTALL TIME: 3-4 HOURS 4WD EQUIPPED VEHICLES ONLY WILL NOT WORK ON CCD EQUIPPED TRUCKS MUST USE ICON UPPER CONTROL ARM: #98522DJ ALL OEM HARDWARE FROM THE KNUCKLE REMOVAL WILL BE REUSED ON THE ICON KNUCKLE. 	



WARNING!
<p>** READ ALL INSTRUCTIONS THOROUGHLY FROM START TO FINISH BEFORE BEGINNING INSTALLATION! IF THESE INSTRUCTIONS ARE NOT PROPERLY FOLLOWED SEVERE FRAME, SUSPENSION AND TIRE DAMAGE MAY RESULT TO THE VEHICLE!</p> <p>** ICON VEHICLE DYNAMICS RECOMMENDS THAT YOU EXERCISE EXTREME CAUTION WHEN WORKING UNDER A VEHICLE THAT IS SUPPORTED WITH JACK STANDS.</p> <p>** ICON VEHICLE DYNAMICS RECOMMENDS ALL INSTALLATION TO BE PERFORMED BY A PROFESSIONAL SHOP/SERVICE TECHNICIAN. PRODUCT FAILURE CAUSED BY IMPROPER INSTALLATION WILL NOT BE COVERED UNDER ICON'S WARRANTY POLICY.</p>

INSTALLATION

- Lift vehicle and securely place heavy duty jack stands under the manufacturer recommended lifting locations for the front of the vehicle. Take care when lifting the vehicle, and allow 3-4" of ground clearance from the tire. NEVER WORK UNDER AN UNSUPPORTED VEHICLE. Remove the wheels/tires.
- Begin by removing the sway bar link from the upper part of the knuckle using a T45 torx and 21mm wrench. [FIGURE 1]

FIG.1



3. Next, remove the ABS and brake line bracket from the knuckle using a 10mm. [FIGURE 2]

FIG.2



4. Remove the brake caliper from the knuckle using a 21mm. Once removed, use a wire hanger or string to support the caliper so it does not hang by the brake line. Remove the rotor and set it aside. [FIGURE 3 & 4]

FIG.3



FIG.4



5. Remove the 3 bolts holding the rotor rock shield from the knuckle using an 8mm. [FIGURE 5 & 6]

FIG.5



FIG.6



6. Remove the speed sensor from the top side of the knuckle, behind the rock shield using a 5mm hex key. [FIGURE 7]

FIG.7



7. Remove the CV axle nut from the hub. Depending on the hub style of your truck, it will be a 13mm or a 36mm socket. If the truck is equipped with electric hubs, also, remove the 4x 8mm bolts from the backside of the knuckle. This will allow the locking portion to be removed with the CV axle shaft. [FIGURE 8, 9 & 10]

FIG.8

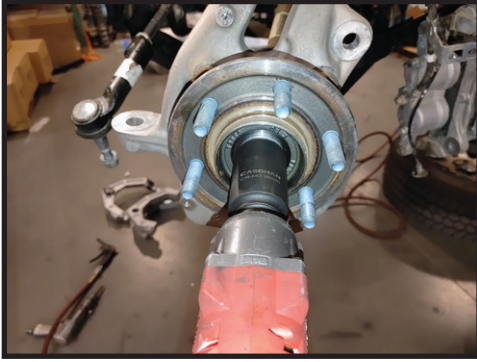

FIG.9

FIG.10



8. Next, loosen the upper balljoint nut using a 18mm. Leave the nut loosely installed. Use a ball joint separator to dislodge the ball joint stud from the knuckle. A hammer can also be used by striking the side of the knuckle. [FIGURE 11 & 12]

FIG.11

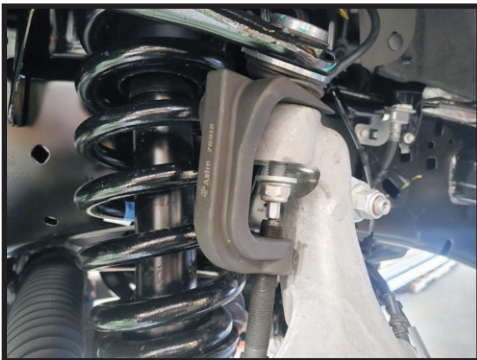

FIG.12



9. Repeat this process on the lower ball joint. Use a 24mm to loosen the nut. [FIGURE 13]

FIG.13



10. The knuckle can now be removed. The upper control arm might be under pressure, take caution when removing the nut. Tilt the arm out and remove the CV axle from the hub, a dead blow hammer can be used to persuade it. Now remove the lower ball joint nut and set the knuckle down.

11. With the knuckle out of the vehicle, the hub can be removed and transfer to the new ICON knuckle, using an 18mm.
[FIGURE 14 & 15]

FIG.14

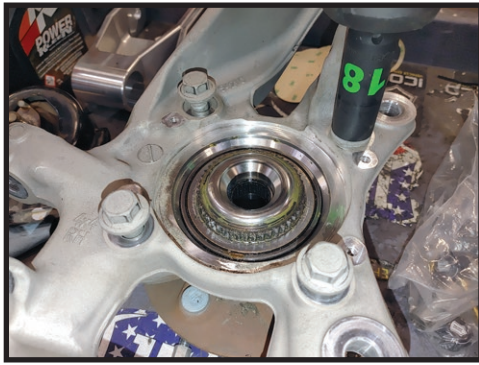
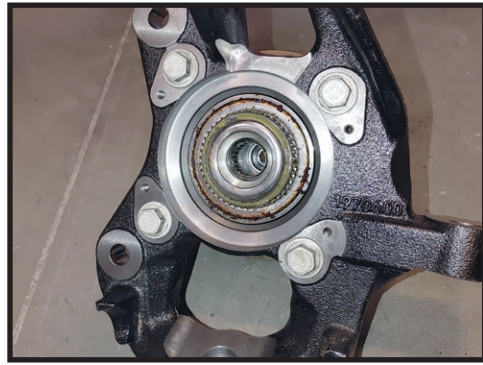

FIG.15



12. Move on to the coilover and upper control arm instructions now. Some steps might be redundant.

13. With the ICON coilover and upper control arm installed, the ICON knuckle can be reinstalled in the reverse order of removal of the OEM knuckle. Be sure to torque all bolts to OEM spec. Red thread locker should be used on the hub and brake caliper bolts and CV axle nut.

VERIFY ALL FASTENERS ARE PROPERLY TORQUED BEFORE DRIVING VEHICLE.

RETORQUE ALL NUTS, BOLTS AND LUGS AFTER 100 MILES AND PERIODICALLY THEREAFTER.

ICON VEHICLE DYNAMICS LIMITED LIFETIME WARRANTY

ICON Vehicle Dynamics warrants to the original retail purchaser who owns the vehicle on which the product was originally installed. ICON Vehicle Dynamics does not warrant the product for finish, alterations, modifications and/or installation contrary to ICON Vehicle Dynamics instructions. ICON Vehicle Dynamics products are not designed, nor are they intended to be installed on vehicles used in race applications, for racing purposes or for similar activities. (A "race" is defined as any contest between two or more vehicles, or a contest of one or more vehicles against the clock, whether or not such contest is for a prize). This warranty does not include coverage for police or taxi vehicles, race vehicles, or vehicles used for government or commercial purposes. Also excluded from this warranty are sales outside of the United States of America and Canada.

ICON Vehicle Dynamics' obligation under this warranty is limited to the repair or replacement, at ICON Vehicle Dynamics' discretion, of the defective product. Any and all costs of removal, installation or re-installation, freight charges and incidental or consequential damages are expressly excluded from this warranty. Items that are subject to wear are not considered defective when worn and are not covered.

ICON Vehicle Dynamics components must be installed as a complete kit as shown in our current application guide. Any substitutions or exemptions of required components will immediately void the warranty. Some finish damage may happen to parts during shipping and is not covered under warranty.

This warranty is expressly in lieu of all other warranties expressed or implied. This warranty shall not apply to any product that has been improperly installed, modified or customized subject to accident, negligence, abuse or misuse.



7929 Lincoln Ave. Riverside, CA 92504 Phone: 951.689.ICON Fax: 951.689.1016
www.iconvehicledynamics.com



FOLLOW US ON FACEBOOK!



7929 Lincoln Ave. Riverside, CA 92504
 Phone: 951.689.ICON | Fax: 951.689.1016

PART #	DESCRIPTION
97721P	21-23 F150 4WD TREMOR REAR 2.5 VS PB PAIR

COMPONENTS INCLUDED	
(2) 194901P-AL 21-23 F150 4WD TREMOR REAR 2.5 AL VS PB	
HARDWARE INCLUDED	
(8) 257164 HEIM SPACER COM10 SPACER X .500 X 1.500 CZINC	
TOOLS REQUIRED	
JACK JACK STANDS PRY BAR TORQUE WRENCH	10MM SOCKET / WRENCH 15MM SOCKET / WRENCH 18MM SOCKET / WRENCH
TECH NOTES	
1. ESTIMATED INSTALL TIME: 1-2 HOURS	
2. YOUR ICON SHOCK ASSEMBLIES COME FACTORY CHARGED TO 250 PSI. RELEASING NITROGEN PRESSURE MAY LEAD TO SHOCK MALFUNCTION AND REDUCED RIDE QUALITY. FAILURE CAUSED BY LOW NITROGEN PRESSURE IS NOT COVERED UNDER ICON'S WARRANTY POLICY.	



WARNING!

**** READ ALL INSTRUCTIONS THOROUGHLY FROM START TO FINISH BEFORE BEGINNING INSTALLATION! IF THESE INSTRUCTIONS ARE NOT PROPERLY FOLLOWED SEVERE FRAME, SUSPENSION AND TIRE DAMAGE MAY RESULT TO THE VEHICLE!**

**** ICON VEHICLE DYNAMICS RECOMMENDS THAT YOU EXERCISE EXTREME CAUTION WHEN WORKING UNDER A VEHICLE THAT IS SUPPORTED WITH JACK STANDS.**

**** ICON VEHICLE DYNAMICS RECOMMENDS ALL INSTALLATION TO BE PERFORMED BY A PROFESSIONAL SHOP/SERVICE TECHNICIAN. PRODUCT FAILURE CAUSED BY IMPROPER INSTALLATION WILL NOT BE COVERED UNDER ICON'S WARRANTY POLICY.**

INSTALLATION

1. Using a properly rated jack, raise the rear of the vehicle and support the frame rails with jack stands. Ensure the jack stands are secure and set properly before lowering the jack. **NEVER WORK UNDER AN UNSUPPORTED VEHICLE.**



FIG.1

2. Remove the factory rear shocks using a 15mm and 18mm socket/wrench. [FIGURE 1]

3. The passenger side upper shock mount needs to be sanded slightly in order for adequate top cap clearance throughout the travel. Sand mount as shown. [FIGURE 2 & 3]



FIG.2

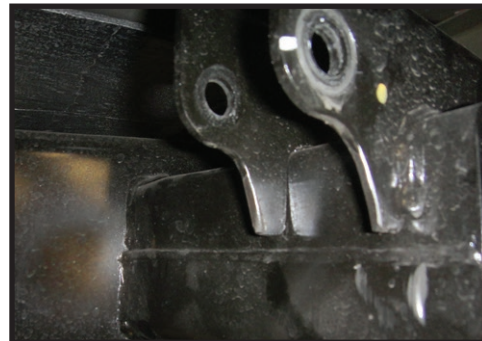

FIG.3

4. Paint exposed metal to prevent rust.

5. Install the ICON rear shocks using a 15mm and an 18mm socket/wrench. Note that the reservoir points away from the axle. [Torque to factory spec] [FIGURE 4, 5 & 6]

FIG.4



FIG.5



FIG.6



***VERIFY ALL FASTENERS ARE PROPERLY TORQUED BEFORE DRIVING VEHICLE.
RETORQUE ALL NUTS, BOLTS AND LUGS AFTER 100 MILES AND PERIODICALLY THEREAFTER.***



2.5 VS SERIES SHOCK & COILOVER TECHNICAL INFORMATION

MAINTENANCE

ICON shock absorbers are a high quality rebuildable race style shock absorber designed for optimal performance. With a unit of this caliber on your vehicle, routine maintenance is required to keep them looking and operating in like new condition. Residual oil and assembly lube may be present at all seal paths from the factory out of the box and is considered normal. Pooling of oil however is not acceptable at any time and one should contact the ICON dealer where purchased.

BELOW ARE GUIDELINES BASED ON HOW YOU USE YOUR VEHICLE BUT YOUR MILEAGE MAY VARY:

STREET USE:

- Send in for factory servicing every 40,000 miles or if a leak develops, ride quality decreases, or they begin to make excessive noise.
- Remove any buildup of road salt, mud, or debris from shocks and coil springs anytime accrued
- Clean with mild soap and water with each oil change or anytime you notice build up.
- Wax the cylinders yearly with automotive wax to prevent corrosion.
- Check nitrogen pressure yearly. (252004 charge needle assembly available at any ICON distributor)
- Check bearings for excessive wear yearly.
- DO NOT apply any type of lube to the upper and lower bearings.

STREET/DIRT:

- Send in for factory servicing every 15,000 miles or if a leak develops, ride quality decreases, or they begin to make excessive noise.
- Clean with mild soap and water with each oil change, offroad trip, or anytime you notice build up.
- Wax the cylinders yearly with automotive wax to prevent corrosion.
- Check nitrogen pressure each dirt outing. (252004 charge needle assembly available at any ICON distributor)
- Check bearings for excessive wear yearly.
- DO NOT apply any type of lube to the upper and lower bearings.

DIRT USE:

- Send in for factory servicing every 1,000 miles.
- Check nitrogen pressure each outing. (252004 charge needle assembly available at any ICON distributor)
- Remove any buildup of mud or debris from shocks and coil springs after every outing.

SELF-SERVICE:

- Contact ICON for service kits & tools at (951) 689-4266.

PRODUCT REGISTRATION

Please visit: <http://www.iconvehicledynamics.com/tech-support/registration/> to register your product.

ICON VEHICLE DYNAMICS SHOCK ABSORBER WARRANTY

This shock absorber has a 1 year warranty against any manufacturer's defects. If a shock fails within the initial year of ownership, the shock must be shipped to ICON Vehicle Dynamics for inspection and service. If a shock is inspected and it has been determined the shock failed due to neglect, damage caused by improper installation or any other reason besides "normal wear and tear", the owner of said shock is responsible for all service costs. This includes labor, parts, and shipping.

ICON Vehicle Dynamics warrants to the original retail purchaser who owns the vehicle on which the product was originally installed. ICON Vehicle Dynamics does not warrant the product for finish, alterations, modifications and/or installation contrary to ICON Vehicle Dynamics instructions. ICON Vehicle Dynamics products are not designed, nor are they intended to be installed on vehicles used in race applications, for racing purposes or for similar activities. (A "race" is defined as any contest between two or more vehicles, or a contest of one or more vehicles against the clock, whether or not such contest is for a prize). This warranty does not include coverage for police or taxi vehicles, race vehicles, or vehicles used for government or commercial purposes. Also excluded from this warranty are sales outside of the United States of America and Canada.

ICON Vehicle Dynamics' obligation under this warranty is limited to the repair or replacement, at ICON Vehicle Dynamics' discretion, of the defective product. Any and all costs of removal, installation or re-installation, freight charges and incidental or consequential damages are expressly excluded from this warranty. Items that are subject to wear are not considered defective when worn and are not covered.

ICON Vehicle Dynamics components must be installed as a complete kit as shown in our current application guide. Any substitutions or exemptions of required components will immediately void the warranty. Some finish damage may happen to parts during shipping and is not covered under warranty.

This warranty is expressly in lieu of all other warranties expressed or implied. This warranty shall not apply to any product that has been improperly installed, modified or customized subject to accident, negligence, abuse or misuse.

To send a shock in for warranty please visit our website <http://www.iconvehicledynamics.com/tech-support/shock-service/>

ICON VEHICLE DYNAMICS LIABILITY DISCLAIMER

ICON does not make any representations or warranties regarding the fitness of any ICON product for a particular installation or conformance of any ICON product with a particular vehicle application. Installation of any ICON suspension system is at the sole discretion of the end user and in making a purchase of any ICON suspension system, the purchaser assumes the responsibility and liability for any and all damage or injury, of any kind or nature whatsoever, caused by, resulting from, arising out of, or occurring in connection with the use or installation of any ICON suspension system. ICON is not liable for and specifically disavows any installation that is not in conformance with original equipment manufacturer's recommendations or instructions. Purchaser agrees that in the event of any claim or lawsuit arising out of the installation or use of an ICON suspension system, purchaser shall indemnify and hold harmless ICON, its agents, employees, officers and owners from and against any and all loss, expense, damage or injury that ICON may sustain as the result of such claim. [ICON defers to and recommends recalibration after suspension installation on 2018 model Toyota vehicles and other manufacturers who make any similar recommendations.]

7929 Lincoln Ave. Riverside, CA 92504
 Phone: 951.689.ICON | Fax: 951.689.1016

PART #	DESCRIPTION
98523DJ	21-23 F150 BILLET UCA DJ PRO KIT

COMPONENTS INCLUDED	
(1) 197521 21 F150 BILLET UCA DRVR DJ PRO	(1) 197522 21 F150 BILLET UCA PASS DJ PRO
HARDWARE INCLUDED	
(4) 157520 L-R ADJ SLEEVE 1.00-14L / .75-16 (2) 177158DJ 21-23 F150 DELTA JOINT PRO (4) 197502 HEIM SPACER RSMX12 X 14MM X 2.125 CZINC (4) 197503 HEIM SPACER RSMX12 X 14MM X 2.775 CZINC (4) 295511 ROD END JM12T F1 FIT	(2) 295570 RETAINING RING WHT-237 SS (2) 295571 -035 O-RING (2) 297165 DELTA PRO BILLET UCA DUST COVER (8) 605002 6-32 X .500 SHCS 18-8 (8) 605145 3/8-16 X 1.000 12PT (1) 605968 BLUE THREAD LOCKER 2ML BULLET
TOOLS REQUIRED	
JACK JACK STANDS TORQUE WRENCH 10MM SOCKET / WRENCH 18MM SOCKET / WRENCH	21MM SOCKET / WRENCH 27MM SOCKET / WRENCH 9/16" SOCKET / WRENCH 5/8" SOCKET / WRENCH T45 TORX
TECH NOTES	
<p>1. ALL ICON UPPER CONTROL ARMS HAVE BEEN ENGINEERED TO ALLOW FOR THE MOST POSSIBLE CASTER, WHILE STILL ALLOWING THE VEHICLE TO BE PROPERLY ALIGNED. NOTIFY YOUR PROFESSIONAL ALIGNMENT SHOP OF THIS INFORMATION SO THAT MAXIMUM RIDE QUALITY CAN BE ACHIEVED.</p> <p>2. ICON DELTA JOINTS ARE PRE-GREASED FROM THE FACTORY. ICON RECOMMENDS GREASING THE DELTA JOINT EVERY 3,000 MILES (OR EVERY OIL CHANGE). ADD NEW GREASE UNTIL ALL OF THE OLD GREASE IS EXPELLED FROM THE BOTTOM OF THE DELTA JOINT ASSEMBLY, WIPE AWAY EXCESS WITH A RAG OR SHOP TOWEL.</p> <p>3. DO NOT EXCEED 1.875" ADJUSTMENT FROM THE CENTER OF THE ROD END TO THE EDGE OF THE BILLET UPPER CONTROL ARM. FAILURE CAUSED BY EXCESSIVE ADJUSTMENT WILL NOT BE COVERED UNDER ICON'S WARRANTY POLICY. REFER TO TECH NOTE #3 PHOTO ON PAGE 5.</p>	

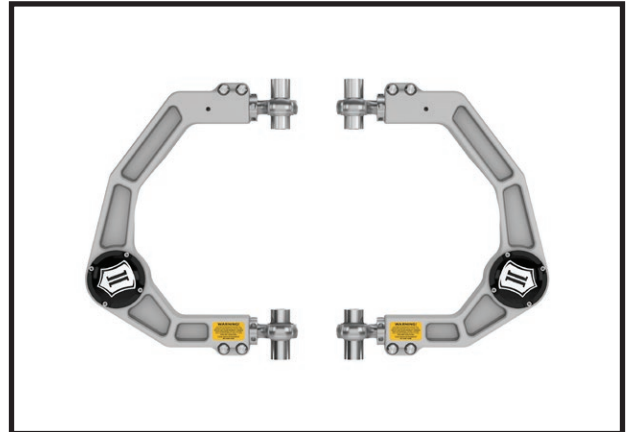

WARNING!
<p>** READ ALL INSTRUCTIONS THOROUGHLY FROM START TO FINISH BEFORE BEGINNING INSTALLATION! IF THESE INSTRUCTIONS ARE NOT PROPERLY FOLLOWED SEVERE FRAME, SUSPENSION AND TIRE DAMAGE MAY RESULT TO THE VEHICLE!</p> <p>** ICON VEHICLE DYNAMICS RECOMMENDS THAT YOU EXERCISE EXTREME CAUTION WHEN WORKING UNDER A VEHICLE THAT IS SUPPORTED WITH JACK STANDS.</p> <p>** ICON VEHICLE DYNAMICS RECOMMENDS ALL INSTALLATION TO BE PERFORMED BY A PROFESSIONAL SHOP/SERVICE TECHNICIAN. PRODUCT FAILURE CAUSED BY IMPROPER INSTALLATION WILL NOT BE COVERED UNDER ICON'S WARRANTY POLICY.</p>

INSTALLATION

- Using a properly rated jack, raise the front of the vehicle and support the frame rails with jack stands. Ensure the jack stands are secure and set properly before lowering the jack. NEVER WORK UNDER AN UNSUPPORTED VEHICLE. Remove the front wheels.
- Remove the coilover/strut assembly to gain access to the upper control arm bolts.
- Remove the 2 nuts from the lower shock mount using an 18mm socket/wrench (5/8" on ICON coilover).
- Support the spindle with a jack or strap and remove the lower control arm bolts from the frame using a 27 and 21mm socket/wrench. This will allow you to separate the lower arm and lower shock studs. [FIGURE 1]

FIG.1



- If you prefer to leave the lower arm in place, use a hammer to press the studs out of the lower bar pin assembly.
 - If ICON coilover is already installed, you do not need to remove the lower control arm from the frame.
- Disconnect the tie rod from the knuckle using a 21mm and 10mm wrench.

6. Remove the 3 nuts from the top of the factory shock assembly with an 18mm socket/wrench (9/16" for ICON coilover). The coilover can then be removed completely. [FIGURE 2]

FIG.2



7. If the lower arm was removed, Reinstall it now, only snugging the bolts in place (They will be torqued at the end).

8. If truck is equipped with Dynamic Bending Headlamps (Automatic ride height adjusting headlights) you will need to remove the bracket. Use a flat blade screwdriver or pry bar to carefully pop the socket off the ball. [FIGURE 3]

FIG.3



9. Remove the sway-bar link and upper control arm from the spindle. Support spindle with a jack or strap to prevent the CV (4x4) or brake lines from over extending (18mm, 21mm, T45 Torx). [FIGURE 4]

FIG.4



10. Remove the UCA from the frame using a 21mm and 18mm socket/wrench.

11. The spacers are installed as pictured, Narrow spacers go towards the coilover. Wide spacers go away from the coilover. [FIGURE 5]

FIG.5

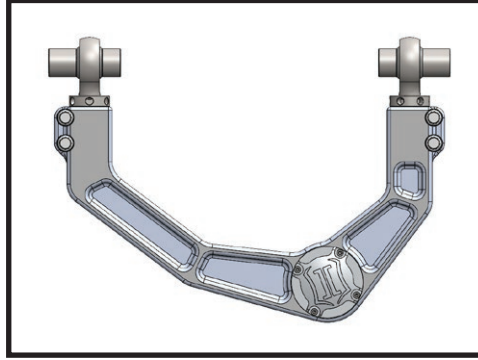

12. If truck is equipped with Dynamic Bending Headlamps (automatic height adjusting headlights) you will need to install the bracket (sold separately) on the driver side billet UCA or the factory ball stud on the tube UCA. The factory ball stud takes a 8mm and 11mm wrench. [FIGURE 6]

FIG.6

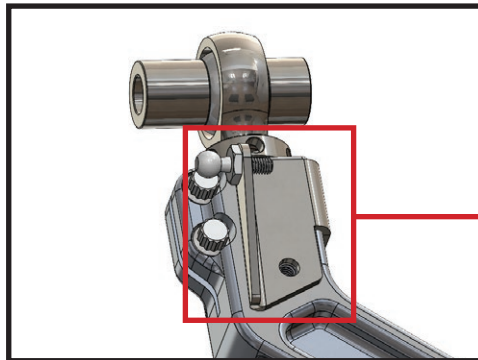

*BILLET UCA
WITH BRACKET*

13. If equipped with the Continuous Control Damping (CCD) or Dynamic Bending Headlamps, the bracket on the frame will need to be removed and moved down 3/4". Remove 11mm bolt that holds the bracket onto the frame. [FIGURE 7]

FIG.7

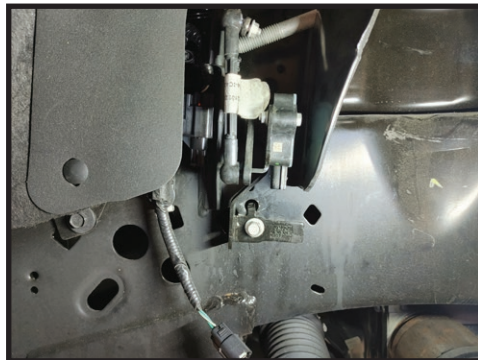

14. Use a screwdriver to lift the clip nut and relocate it down 3/4". Mark the center of the hole and drill it out to 1/2". [FIGURE 8, 9, 10]

FIG.8

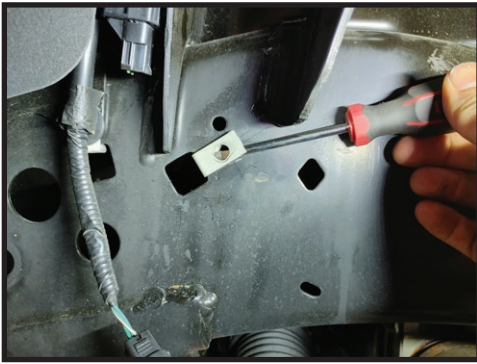

FIG.9

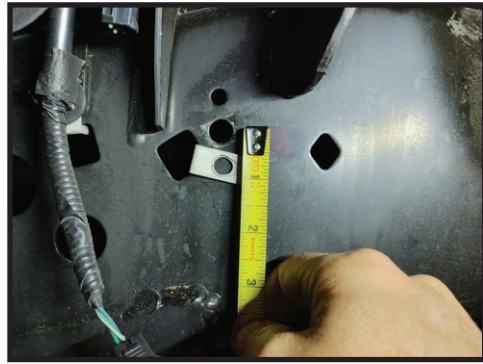
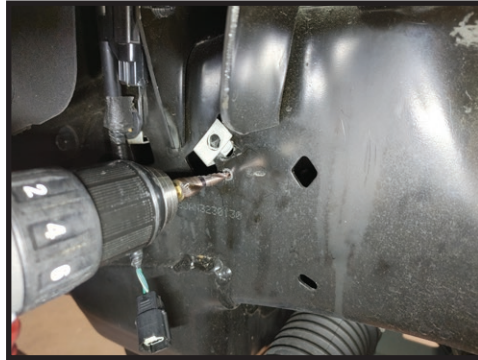
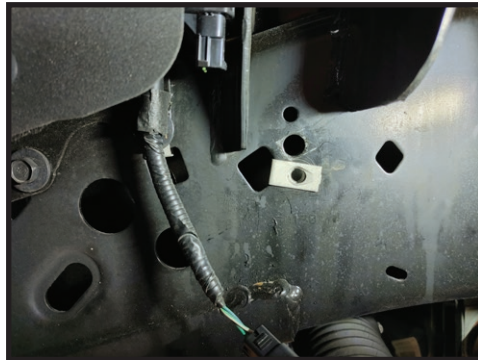

FIG.10



15. Place clip nut into the new hole. [FIGURE 11]

FIG.11



16. Install the bracket and sensor tab into the old bolt hole and use the factory hardware to secure it into the new location.

17. Place the ICON upper control arm into the mounts on the chassis and hand tighten using OEM hardware.

18. Reinstall OEM shock or refer to ICON coil over assembly instructions now.

19. Install tapered pin of UCA into the spindle and tighten using the supplied nut and 18mm socket/wrench. [Torque to 75 ft-lbs] [FIGURE 12]

FIG.12



20. Tighten the UCA bolts at the chassis using a 21mm and 18mm socket/wrench. [Torque to factory spec]
21. Install the Delta Joint dust cap and o-ring using the 4 socket head screws.
22. Repeat steps on opposite side.
23. Reinstall wheels and carefully lower vehicle to the ground. [Torque lug nuts to factory spec]
24. If the lower control arm was removed, now is the time to tighten the frame bolts. [Torque to factory spec]
25. Have the vehicle professionally aligned.



[TECH NOTE #3]

VERIFY ALL FASTENERS ARE PROPERLY TORQUED BEFORE DRIVING VEHICLE.

RETORQUE ALL NUTS, BOLTS AND LUGS AFTER 100 MILES AND PERIODICALLY THEREAFTER.

ICON VEHICLE DYNAMICS LIMITED LIFETIME WARRANTY

ICON Vehicle Dynamics warrants to the original retail purchaser who owns the vehicle on which the product was originally installed. ICON Vehicle Dynamics does not warrant the product for finish, alterations, modifications and/or installation contrary to ICON Vehicle Dynamics instructions. ICON Vehicle Dynamics products are not designed, nor are they intended to be installed on vehicles used in race applications, for racing purposes or for similar activities. (A "race" is defined as any contest between two or more vehicles, or a contest of one or more vehicles against the clock, whether or not such contest is for a prize). This warranty does not include coverage for police or taxi vehicles, race vehicles, or vehicles used for government or commercial purposes. Also excluded from this warranty are sales outside of the United States of America and Canada.

ICON Vehicle Dynamics' obligation under this warranty is limited to the repair or replacement, at ICON Vehicle Dynamics' discretion, of the defective product. Any and all costs of removal, installation or re-installation, freight charges and incidental or consequential damages are expressly excluded from this warranty. Items that are subject to wear are not considered defective when worn and are not covered.

ICON Vehicle Dynamics components must be installed as a complete kit as shown in our current application guide. Any substitutions or exemptions of required components will immediately void the warranty. Some finish damage may happen to parts during shipping and is not covered under warranty.

This warranty is expressly in lieu of all other warranties expressed or implied. This warranty shall not apply to any product that has been improperly installed, modified or customized subject to accident, negligence, abuse or misuse.



ICON VEHICLE DYNAMICS®
PERFORMANCE SUSPENSION SYSTEMS AND SHOCK ABSORBERS

7929 Lincoln Ave. Riverside, CA 92504 Phone: 951.689.ICON Fax: 951.689.1016
www.iconvehicledynamics.com



FOLLOW US ON FACEBOOK!



7929 Lincoln Ave. Riverside, CA 92504
Phone: 951.689.ICON | Fax: 951.689.1016

PART #	DESCRIPTION
198510	17-20 RAPTOR MULTI RATE LEAF SPRING KIT

COMPONENTS INCLUDED	
(1) 198510 17-20 RAPTOR F150 MULTI-RATE LEAF SPRING W/ ADD A LEAF	
HARDWARE INCLUDED	
N/A	
TOOLS REQUIRED	
JACK JACK STANDS GRINDER W/ CUT-OFF WHEEL (OR SAWZALL) VISE GRIPS C-CLAMPS TORQUE WRENCH 9/16" SOCKET / WRENCH 3/4" SOCKET / WRENCH	15/16" SOCKET / WRENCH 10MM SOCKET / WRENCH 15MM SOCKET / WRENCH 18MM SOCKET / WRENCH 19MM SOCKET / WRENCH 21MM SOCKET / WRENCH 24MM SOCKET / WRENCH 27MM SOCKET / WRENCH
TECH NOTES	
<p>1. ICON MULTI-RATE LEAF SPRING KIT REQUIRES BUMP STOP SPACER KIT (95226) IF ICON HYDRAULIC BUMP STOP KIT (95121) IS NOT USED.</p> <p>2. ICON MULTI-RATE LEAF SPRING KIT REQUIRES HARDWARE KIT (95225H) FOR INSTALLATION.</p> <p>THE ICON MULTI-RATE LEAF SPRING IS MODULAR, MEANING THAT YOU CAN CONFIGURE THE SPRING PACK TO YOUR DESIRED SETTING FROM THESE AVAILABLE OPTIONS:</p> <p>OPTION #1 - THE SPRING IS SHIPPED AT THIS SETTING (LIGHTEST SPRING RATE).</p> <p>OPTION #2 - REPLACE THE 3RD SPRING (COUNTING FROM THE TOP DOWN, NOT INCLUDING THE HALF LENGTH REBOUND LEAF) WITH THE ADDITIONAL LEAF.</p> <p>OPTION #3 - PLACE THE ADDITIONAL LEAF IN THE 3RD SPRING POSITION (COUNTING FROM THE TOP DOWN, NOT INCLUDING THE HALF LENGTH REBOUND LEAF). DO NOT REMOVE LEAF FROM THE SPRING PACK.</p> <p>ICON'S MEASURED SPECS FROM OUR TEST TRUCK (2017 CREW CAB RAPTOR):</p> <p>OPTION #1 - LIFT HEIGHT OVER STOCK: + 1.00" (UNLOADED)</p> <p>OPTION #2 - LIFT HEIGHT OVER STOCK + 2.25" (UNLOADED) LIFT HEIGHT OVER STOCK WITH 400LBS IN BED: + 1.00"</p> <p>OPTION #3 - LIFT HEIGHT OVER STOCK: + 3.00" (UNLOADED) LIFT HEIGHT OVER STOCK WITH 850LBS IN BED: + .50"</p>	



WARNING!
<p>** READ ALL INSTRUCTIONS THOROUGHLY FROM START TO FINISH BEFORE BEGINNING INSTALLATION! IF THESE INSTRUCTIONS ARE NOT PROPERLY FOLLOWED SEVERE FRAME, SUSPENSION AND TIRE DAMAGE MAY RESULT TO THE VEHICLE!</p> <p>** ICON VEHICLE DYNAMICS RECOMMENDS THAT YOU EXERCISE EXTREME CAUTION WHEN WORKING UNDER A VEHICLE THAT IS SUPPORTED WITH JACK STANDS.</p> <p>** ICON VEHICLE DYNAMICS RECOMMENDS ALL INSTALLATION TO BE PERFORMED BY A PROFESSIONAL SHOP/SERVICE TECHNICIAN. PRODUCT FAILURE CAUSED BY IMPROPER INSTALLATION WILL NOT BE COVERED UNDER ICON'S WARRANTY POLICY.</p>

INSTALLATION

- Using a properly rated jack, raise the rear of the vehicle and support the frame rails with jack stands. Ensure the jack stands are secure and set properly before lowering the jack. NEVER WORK UNDER AN UNSUPPORTED VEHICLE. Remove the rear wheels.
- With a floor jack under the rear end, slightly raise the rear axle housing from full droop to remove tension from the shock, loosen and remove the shocks. Make sure the axle is well supported. Keep all of the hardware, it will be reused.
- Remove the parking brake bracket from the driver side front spring pocket using a 10mm to allow access to the spring bolt. With the screw removed, grind or cut the screw shorter to provide more room for the leaf spring in the pocket. [FIGURE 1 & 2]

FIG.1



FIG.2



- Remove the vent line from the axle and remove the vent fitting which also holds the brake line bracket to the axle tube. This will allow for additional flex in the lines so the axle may be drooped further.

5. Slowly lower the axle to unload the tension in the leaf spring. When the axle reaches full droop on the leaf springs jack the rear end back up about 1" to relieve any negative pressure in the spring and to insure that the axle weight is being supported by the jack.
6. Replace one side at a time so that the other side helps maintain pinion angle and prevents the drive shaft from pulling out. However, loosening the U-bolts slightly on both sides during the installation process reduces bind and aids in the installation.
7. Starting on the driver's side, remove the U-bolts and lower U-bolt plate. Lower the axle slightly to disengage the center pins from the block and axle pad. Remove the factory block.
8. Using a 21mm and a 24mm, loosen the upper shackle bolt and remove the nut from the lower shackle bolt. [FIGURE 3]

FIG.3



FIG.4



9. The front spring bolt cannot be removed because of interference with the gas tank and exhaust so it must be cut out. New bolts are supplied in the hardware kit (95225H). Remove the nut from the front spring bolt, it will be reused (27mm nut, 24mm head). Push the bolt back through the hole so that there is adequate shank exposed under the head of the bolt to cut the head off. This can be done with either an abrasive cutting disc or reciprocating saw. Clamping a vise grip on the nut end of the bolt helps hold the bolt while cutting. Cut the head off of the bolt. [FIGURE 4]
10. The spring is now only being held in by the shank of the front bolt and the lower rear shackle bolt. This is a heavy assembly so use caution when removing the bolts, use a helper if possible. Remove the bolts and remove the spring from the vehicle.
11. Remove the shackle from the stock spring noting the orientation of the shackle and the direction of the bolt, the open part of the formed metal shackle should be toward the spring. If the shackle is put on backward it can bind against the leaf pack under compression of the suspension. Install the shackle on the new spring, start the nut but DO NOT TIGHTEN.
12. Install the spring in the vehicle, again, its heavy so use a helper. Install the new front bolt in the opposite direction from factory, from the outside inward and start the nut but do not tighten. Install the lower shackle bolt, start the nut but do not tighten.
13. Trim the center pins: Cut off the excess thread leaving 2-3 threads above the nut on the center pins. [FIGURE 5]

FIG.5



FIG.6

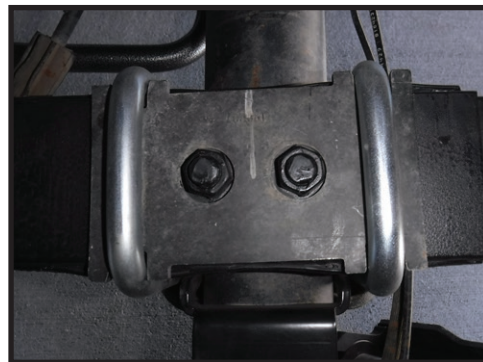

14. Raise the axle up to the spring and align the center pins in the spring pad. Place the clamp plate on top of the leaf pack. Install the new U-bolts using the openings in the spring plate to locate them correctly. Install the factory lower spring plate, washers and nuts. Take up the slack in the U-bolts but do not tighten. [FIGURE 6]
15. Repeat steps 7-14 on passenger side.
16. Raise the axle enough to reinstall the shocks. Tighten the U-bolts to approximately 40 ft-lbs. Final torque will be set with the truck sitting under its own weight on the ground.
17. Reattach the lower brake line bracket and vent line. Connect the parking brake bracket to the front driver side spring pocket using the shorter screw and torque to factory spec using a 10mm.
18. Reinstall the tires and lower the vehicle to the ground. Bounce the back of the truck a couple of times to let the bushings center at ride height.
19. Torque the front spring eye and shackle bolts: Front bolt 181 ft-lbs, Shackle bolts 89 ft-lbs.
20. Torque the U-bolts 145 ft-lbs.

RATE CHANGE INSTRUCTIONS:

- 1.** Using a properly rated jack, raise the rear of the vehicle and support the frame rails with jack stands. Ensure the jack stands are secure and set properly before lowering the jack. NEVER WORK UNDER AN UNSUPPORTED VEHICLE. Remove the rear wheels.
- 2.** With a floor jack under the rear end, slightly raise the rear axle housing from full droop to remove tension from the shock, loosen and remove the shocks. Make sure the axle is well supported. Keep all of the hardware, it will be reused.
- 3.** Remove the vent line from the axle and remove the vent fitting which also holds the brake line bracket to the axle tube. This will allow for additional flex in the lines so the axle may be drooped further.
- 4.** Slowly lower the axle to unload the tension in the leaf spring. When the axle reaches full droop on the leaf springs jack the rear end back up about 1" to relieve any negative pressure in the spring and to insure that the axle weight is being supported by the jack.
- 5.** Replace one side at a time so that the other side helps maintain pinion angle and prevents the drive shaft from pulling out. However loosening the U-bolts slightly on both sides during the installation process reduces bind and aids in the installation.
- 6.** Lower the axle so there is a couple of inches clearance between the leaf pack and the spring pad.
- 7.** Use a C-Clamp to clamp the first 3 leaves on the front and the first 2 leaves in the back together to help hold them in the vehicle and maintain their alignment. [FIGURE 1 & 2]

FIG.1



FIG.2



- 8.** Remove the cross bolts and sleeves from the spring retainers. Carefully loosen the center pins, it may be necessary to hold the head of the pins with a vise grip. There may be some residual force left in the spring before the nuts are fully off the center pin so it helps to use a C-Clamp near the middle of the pack also to slowly release the pressure.
- 9.** Remove the bottom 5 leaves of the pack.

SPRING RATE CHANGE OPTIONS:

Counting from the top down (not including the half length rebound leaf), you can either replace the 3rd spring with the add-a-leaf or leave the existing spring installed and make the add-a-leaf the new 3rd spring.

Add-a-leaf replaces #3 = 1.25" higher ride height (unloaded) and 20% higher spring rate
Add-a-leaf becomes #3 = 2.0" higher ride height (unloaded) and 40% higher spring rate

- 10.** Add or replace the additional leaf and additional separator plate to the pack. Line up all the holes and put the new center pins through the pack. The center pins are fine thread, use care not to damage the threads on assembly. [FIGURE 3]

FIG.3



- 11.** Put the bottom half of the pack back in the vehicle guiding the center pins up through the upper 3 leaves. A long drift punch helps to align the holes. It may be helpful to loosen the 2 C-Clamps slightly on the front and rear to help shift all leaves into position. Use a large C-Clamp near the middle to pull everything together until you can get the nuts started on the center pin.
- 12.** Tighten the center pins to 54 ft-lbs. Reinstall the cross bolts and sleeves in the retainer clips. Make sure the bolt go from the inside out with the head toward the frame for clearance. Trim the center pins: Cut off the excess thread 2-3 threads above the nut on the center pins.

MULTI-RATE LEAF SPRING RATE CHANGE OPTIONS

(General application for all models. Refer to these instructions for specific rates)

OPTION 1

ADDITIONAL
LEAF
NOT USED

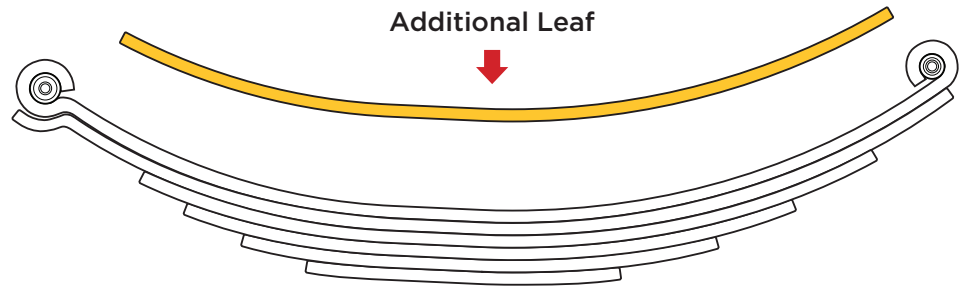

OPTION 2

ADDITIONAL
LEAF
REPLACES
LEAF

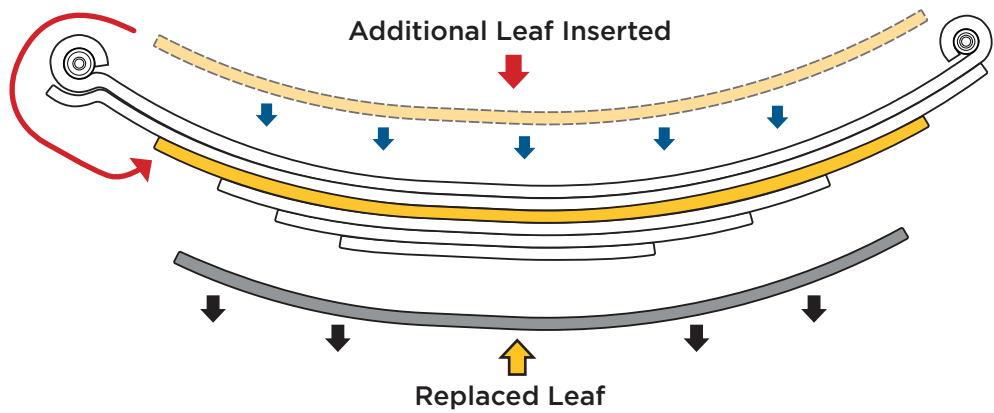

OPTION 3

ADDITIONAL
LEAF ADDED
TO PACK

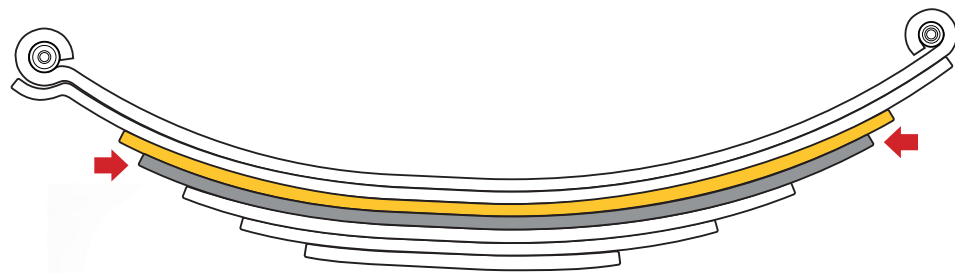

13. Raise the axle up to the spring and align the center pins in the spring pad. Place the clamp plate on top of the leaf pack. Install the U-bolts using the openings in the spring plate to locate them correctly. Install the factory lower spring plate, washers and nuts. Take up the slack in the U-bolts but **DO NOT TIGHTEN**.

14. Repeat process on opposite side.

15. Raise the axle enough to reinstall the shocks. Tighten the U-bolts to approximately 40 ft-lbs. Final torque will be set on the ground. Reattach the lower brake line bracket and vent line.

16. Reinstall the tires and lower the vehicle to the ground. Torque U-bolts to 145 ft-lbs.

VERIFY ALL FASTENERS ARE PROPERLY TORQUED BEFORE DRIVING VEHICLE.

RETORQUE ALL NUTS, BOLTS AND LUGS AFTER 100 MILES AND PERIODICALLY THEREAFTER.

ICON VEHICLE DYNAMICS LIMITED LIFETIME WARRANTY

ICON Vehicle Dynamics warrants to the original retail purchaser who owns the vehicle on which the product was originally installed. ICON Vehicle Dynamics does not warrant the product for finish, alterations, modifications and/or installation contrary to ICON Vehicle Dynamics instructions. ICON Vehicle Dynamics products are not designed, nor are they intended to be installed on vehicles used in race applications, for racing purposes or for similar activities. (A "race" is defined as any contest between two or more vehicles, or a contest of one or more vehicles against the clock, whether or not such contest is for a prize). This warranty does not include coverage for police or taxi vehicles, race vehicles, or vehicles used for government or commercial purposes. Also excluded from this warranty are sales outside of the United States of America and Canada.

ICON Vehicle Dynamics' obligation under this warranty is limited to the repair or replacement, at ICON Vehicle Dynamics' discretion, of the defective product. Any and all costs of removal, installation or re-installation, freight charges and incidental or consequential damages are expressly excluded from this warranty. Items that are subject to wear are not considered defective when worn and are not covered.

ICON Vehicle Dynamics components must be installed as a complete kit as shown in our current application guide. Any substitutions or exemptions of required components will immediately void the warranty. Some finish damage may happen to parts during shipping and is not covered under warranty.

This warranty is expressly in lieu of all other warranties expressed or implied. This warranty shall not apply to any product that has been improperly installed, modified or customized subject to accident, negligence, abuse or misuse.

ICON VEHICLE DYNAMICS LIABILITY DISCLAIMER

ICON does not make any representations or warranties regarding the fitness of any ICON product for a particular installation or conformance of any ICON product with a particular vehicle application. Installation of any ICON suspension system is at the sole discretion of the end user and in making a purchase of any ICON suspension system, the purchaser assumes the responsibility and liability for any and all damage or injury, of any kind or nature whatsoever, caused by, resulting from, arising out of, or occurring in connection with the use or installation of any ICON suspension system. ICON is not liable for and specifically disavows any installation that is not in conformance with original equipment manufacturer's recommendations or instructions. Purchaser agrees that in the event of any claim or lawsuit arising out of the installation or use of an ICON suspension system, purchaser shall indemnify and hold harmless ICON, its agents, employees, officers and owners from and against any and all loss, expense, damage or injury that ICON may sustain as the result of such claim. [If applicable, ICON defers to and recommends recalibration of any/all vehicle stability systems after suspension installation.]



ICON VEHICLE DYNAMICS®

PERFORMANCE SUSPENSION SYSTEMS AND SHOCK ABSORBERS

7929 Lincoln Ave. Riverside, CA 92504 Phone: 951.689.ICON Fax: 951.689.1016
www.iconvehicledynamics.com



FOLLOW US ON FACEBOOK!

