

7929 Lincoln Ave. Riverside, CA 92504
Phone: 951.689.ICON | Fax: 951.689.1016

PART #	DESCRIPTION
91824E	21-UP F150 TREMOR 2-3" 2.5 VS RR CDEV COILOVER KIT

COMPONENTS INCLUDED	
(1) 194800ED 21-UP F150 TREMOR 2-3" 2.5 CO RR CDEV UPKG DRIV	(1) 194800EP 21-UP F150 TREMOR 2-3" 2.5 CO RR CDEV UPKG PASS
HARDWARE INCLUDED	
(2) 250005 RESI BRACKETS (2) 605131 3/8" SPLIT LOCK WASHER (1) 255604-06 EXTENSIOIN HARNESS COIL 6FT	(2) 605144 3/8-12 X .750" FLANGED SELF-TAP BOLT (1) 611051 #36 HOSE CLAMPS (4) (1) 255604-08 EXTENSION HARNESS COIL 8FT
611019 HARDWARE KIT	
(6) 605101 3/8"-16 X 1.00" HHCS	(6) 605131 3/8" SPLIT LOCK WASHER
611052 HARDWARE KIT	
(4) 605205 7/16"-14 X 2.75" HHCS (4) 605230 7/16" SAE FLAT WASHER	(4) 605231 WASHER-1.00" X 0.469" X 0.125"
TOOLS REQUIRED	
JACK JACK STANDS TORQUE WRENCH 8MM SOCKET / WRENCH 10MM SOCKET / WRENCH 18MM SOCKET / WRENCH	21MM SOCKET / WRENCH 27MM SOCKET / WRENCH 5/16" SOCKET / WRENCH 9/16" SOCKET / WRENCH 5/8" SOCKET / WRENCH
TECH NOTES	
1. ESTIMATED INSTALL TIME: 2-3 HOURS	
2. YOUR ICON COILOVER ASSEMBLIES COME FACTORY CHARGED TO 250 PSI. RELEASING NITROGEN PRESSURE MAY LEAD TO SHOCK MALFUNCTION AND REDUCED RIDE QUALITY. FAILURE CAUSED BY LOW NITROGEN PRESSURE IS NOT COVERED UNDER ICON'S WARRANTY POLICY.	
3. MUST BE USED WITH ICON UCA 98522DJ OR 98523DJ.	
4. FOR TREMOR EQUIPPED TRUCKS ONLY.	
5. THE SHOCKS SHIP AT ICON'S RECOMMENDED RIDE HEIGHT. ICON DOES NOT RECOMMEND ADJUSTING THE COIL BEYOND 1.75" OF THREADS BETWEEN THE BOTTOM OF THE TOP CAP AND THE TOP OF THE COIL NUT. ADJUSTING BEYOND 1.75" OF THREAD SHOWING WILL REDUCE RIDE QUALITY. DO NOT EXCEED 2.5" OF EXPOSED THREADS.	



WARNING!
** READ ALL INSTRUCTIONS THOROUGHLY FROM START TO FINISH BEFORE BEGINNING INSTALLATION! IF THESE INSTRUCTIONS ARE NOT PROPERLY FOLLOWED SEVERE FRAME, SUSPENSION AND TIRE DAMAGE MAY RESULT TO THE VEHICLE!
** ICON VEHICLE DYNAMICS RECOMMENDS THAT YOU EXERCISE EXTREME CAUTION WHEN WORKING UNDER A VEHICLE THAT IS SUPPORTED WITH JACK STANDS.
** ICON VEHICLE DYNAMICS RECOMMENDS ALL INSTALLATION TO BE PERFORMED BY A PROFESSIONAL SHOP/SERVICE TECHNICIAN. PRODUCT FAILURE CAUSED BY IMPROPER INSTALLATION WILL NOT BE COVERED UNDER ICON'S WARRANTY POLICY.

4. Remove the 2 nuts from the lower shock mount using an 18mm socket/wrench. [FIGURE 2]

INSTALLATION

- Using a properly rated jack, raise the front of the vehicle and support the frame rails with jack stands. Ensure the jack stands are secure and set properly before lowering the jack. NEVER WORK UNDER AN UNSUPPORTED VEHICLE. Remove the front wheels/tires.
- Disconnect the tie rod from the spindle using a 21mm and 10mm wrench.
- Disconnect the sway bar link from spindle using a 21mm and T45 torx wrench. [FIGURE 1]

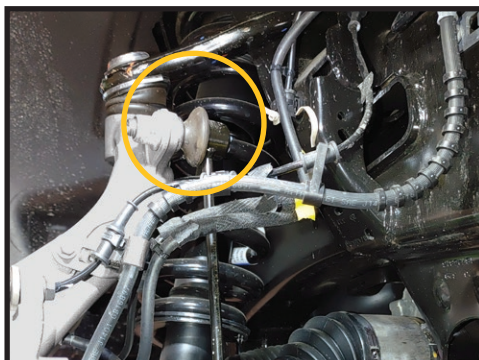

FIG.1



FIG.2

5. Support the spindle with a jack or strap and remove the lower control arm bolts from the frame using a 27 and 21mm socket/wrench. This will allow you to separate the lower arm and lower shock studs. [FIGURE 3]

FIG.3



If you prefer to leave the lower arm in place, use a hammer to push the studs out of the lower bar pin assembly.

6. Remove the 3 nuts from the top of the factory shock assembly with an 18mm socket/wrench. The coilover can then be removed completely. [FIGURE 4]

FIG.4



7. If the Lower arm was removed, re-install it at this time. Do not torque the pivot bolts until the truck is sitting on its own weight.

8. Using a hammer or a ball joint separator, separate the taper from the spindle. Remove the nut and disconnect the UCA from the spindle. if applicable, refer to ICON Delta Joint Upper Control Arm installation instruction at this time.

9. Install ICON coil-over assembly now, using supplied 3/8" bolts (605101) and washers (605131) using a 9/16" socket/wrench [Torque to 30 ft-lbs]. The top cap fitting points out, away from the frame. [FIGURE 5]

FIG.5



10. Use the supplied 7/16" bolts and washers to secure the ICON coil-over to the lower arm using a 5/8" wrench/socket. [Torque to 50 ft-lbs] The bar pin is installed to offset the shock forward to increase axle clearance. Each 7/16" bolt will get 2 washers, the thicker black oxide washer will go against the Lower control arm, while the thinner yellow zinc washer will go against the head of the bolt. [FIGURE 6 & 7]

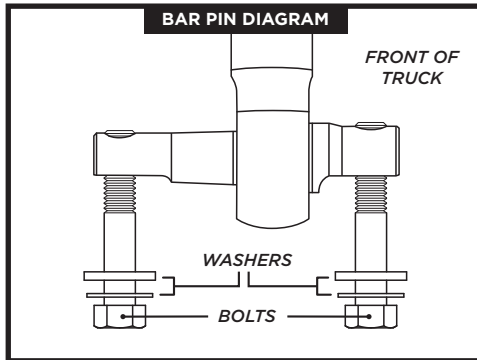

FIG.6



FIG.7

11. Connect the upper control arm to the knuckle using an 18mm socket/wrench. [Torque OEM balljoint to factory spec] [75 ft-lbs for the ICON DELTA JOINT]

12. Connect the tie rod to the spindle using a 21mm and 10mm wrench. [Torque to factory spec]

13. Connect the swaybar link to the spindle using a 21mm and T45 torx wrench.

14. Hold the Reservoir bracket in position as shown. Mark and center punch the bolt hole location. Use a 11/32" drill bit and drill the hole. Then use supplied self-tapping bolt (605144) with lock washer (605131) to mount the reservoir bracket using a 9/16" socket/wrench. [FIGURE 8]



FIG.8

15. Mount the reservoir to the bracket using supplied hose clamps and a flat head screw driver or 5/16" socket/wrench.

16. Repeat steps for passenger side.

17. Install Wheels and lower vehicle to the ground. [Torque to factory spec]

18. If the lower arms were removed from the frame pivots, tighten the bolts now. [Torque to factory spec]

19. Have the truck professionally aligned.

VERIFY ALL FASTENERS ARE PROPERLY TORQUED BEFORE DRIVING VEHICLE.

RETORQUE ALL NUTS, BOLTS AND LUGS AFTER 100 MILES AND PERIODICALLY THEREAFTER.

2.5 VS SERIES SHOCK & COILOVER TECHNICAL INFORMATION

MAINTENANCE

ICON shock absorbers are a high quality rebuildable race style shock absorber designed for optimal performance. With a unit of this caliber on your vehicle, routine maintenance is required to keep them looking and operating in like new condition. Residual oil and assembly lube may be present at all seal paths from the factory out of the box and is considered normal. Pooling of oil however is not acceptable at any time and one should contact the ICON dealer where purchased.

BELOW ARE GUIDELINES BASED ON HOW YOU USE YOUR VEHICLE BUT YOUR MILEAGE MAY VARY:

STREET USE:

- Send in for factory servicing every 40,000 miles or if a leak develops, ride quality decreases, or they begin to make excessive noise.
- Remove any buildup of road salt, mud, or debris from shocks and coil springs anytime accrued
- Clean with mild soap and water with each oil change or anytime you notice build up.
- Wax the cylinders yearly with automotive wax to prevent corrosion.
- Check nitrogen pressure yearly. (252004 charge needle assembly available at any ICON distributor)
- Check bearings for excessive wear yearly.
- DO NOT apply any type of lube to the upper and lower bearings.

STREET/DIRT:

- Send in for factory servicing every 15,000 miles or if a leak develops, ride quality decreases, or they begin to make excessive noise.
- Clean with mild soap and water with each oil change, offroad trip, or anytime you notice build up.
- Wax the cylinders yearly with automotive wax to prevent corrosion.
- Check nitrogen pressure each dirt outing. (252004 charge needle assembly available at any ICON distributor)
- Check bearings for excessive wear yearly.
- DO NOT apply any type of lube to the upper and lower bearings.

DIRT USE:

- Send in for factory servicing every 1,000 miles.
- Check nitrogen pressure each outing. (252004 charge needle assembly available at any ICON distributor)
- Remove any buildup of mud or debris from shocks and coil springs after every outing.

SELF-SERVICE:

- Contact ICON for service kits & tools at (951) 689-4266.

PRODUCT REGISTRATION

Please visit: <http://www.iconvehicledynamics.com/tech-support/registration/> to register your product.

ICON VEHICLE DYNAMICS SHOCK ABSORBER WARRANTY

This shock absorber has a 1 year warranty against any manufacturer's defects. If a shock fails within the initial year of ownership, the shock must be shipped to ICON Vehicle Dynamics for inspection and service. If a shock is inspected and it has been determined the shock failed due to neglect, damage caused by improper installation or any other reason besides "normal wear and tear", the owner of said shock is responsible for all service costs. This includes labor, parts, and shipping.

ICON Vehicle Dynamics warrants to the original retail purchaser who owns the vehicle on which the product was originally installed. ICON Vehicle Dynamics does not warrant the product for finish, alterations, modifications and/or installation contrary to ICON Vehicle Dynamics instructions. ICON Vehicle Dynamics products are not designed, nor are they intended to be installed on vehicles used in race applications, for racing purposes or for similar activities. (A "race" is defined as any contest between two or more vehicles, or a contest of one or more vehicles against the clock, whether or not such contest is for a prize). This warranty does not include coverage for police or taxi vehicles, race vehicles, or vehicles used for government or commercial purposes. Also excluded from this warranty are sales outside of the United States of America and Canada.

ICON Vehicle Dynamics' obligation under this warranty is limited to the repair or replacement, at ICON Vehicle Dynamics' discretion, of the defective product. Any and all costs of removal, installation or re-installation, freight charges and incidental or consequential damages are expressly excluded from this warranty. Items that are subject to wear are not considered defective when worn and are not covered.

ICON Vehicle Dynamics components must be installed as a complete kit as shown in our current application guide. Any substitutions or exemptions of required components will immediately void the warranty. Some finish damage may happen to parts during shipping and is not covered under warranty.

This warranty is expressly in lieu of all other warranties expressed or implied. This warranty shall not apply to any product that has been improperly installed, modified or customized subject to accident, negligence, abuse or misuse.

To send a shock in for warranty please visit our website <http://www.iconvehicledynamics.com/tech-support/shock-service/>



ICON VEHICLE DYNAMICS®
PERFORMANCE SUSPENSION SYSTEMS AND SHOCK ABSORBERS

7929 Lincoln Ave. Riverside, CA 92504 Phone: 951.689.ICON Fax: 951.689.1016
www.iconvehicledynamics.com



FOLLOW US ON FACEBOOK!



7929 Lincoln Ave. Riverside, CA 92504
Phone: 951.689.ICON | Fax: 951.689.1016

PART #	DESCRIPTION
93500	F-SERIES IIC INSTALL KIT

COMPONENTS INCLUDED	
(1) 254408 15-UP F-150 E-CONTROLLER MOUNT (1) 255600 IIC CONTROLLER (1) 255601 BLOCK OFF PLUG	(1) 255602 MAIN HARNESS IIC CONTROLLER (1) 255605-10 FUSE HOLDER 10 AMP (1) 255608 FUSE TAP MICRO2
HARDWARE INCLUDED	
(1) 605033 1/4 - 14 X .750 SELF DRILLING/ TAPPING SCREW (2) 605052 1/4-20 NYLOCK NUT (4) 605053 1/4 FLAT WASHER (2) 605054 1/4-20 X .750 BOLT (2) 605069 1/4-20 X 1.25 HHCS GR8 YZINC FULLY THREADED (2) 605750 BUTT CONNECTOR, 18GA, HEAT SHRINK	(3) 605751 TERMINAL CONNECTOR 5/16", 18 GA, HEAT SHRINK (1) 605755 FUSE, 5 AMP MICRO2 (1) 605760 WIRE LOOM 1/4" X 6-FT (1) 605926 5-1/2 X 0.14 NYLON CABLE TIE, BLACK PACK OF 100 (2) 605984 RUBBER STRIP 1" X 3" X 1/32", ADHESIVE BACK
F-150 SHOCK WIRES	
(1) 255604-06 6-FT WIRE (1) 255604-08 8-FT WIRE	(2) 255604-26 26-FT WIRE
FSD SHOCK WIRES:	
(1) 255604-06 6-FT WIRE (1) 255604-14 14-FT WIRE	(1) 255604-20 20-FT WIRE (1) 255604-30 30-FT WIRE
TOOLS REQUIRED	
FLUSH CUTS PHILLIPS HEAD SCREWDRIVER 1/4" DRILL BIT TORQUE WRENCH HEAT GUN	WIRE STRIPPER WIRE CRIMPER WIRE CUTTERS 8MM SOCKET / WRENCH 10MM SOCKET / WRENCH 7/16" SOCKET / WRENCH
TECH NOTES	
<ol style="list-style-type: none"> FOR 15-UP F-150 IIC INSTALL KIT INSTALLATION, SKIP TO PAGE 7. WIRE LENGTHS ARE MEASURED FOR A 4-DOOR SHORT BED. GOLD WIRE COLOR IN FIGURES DENOTES BASIC WIRE PATH (FOR CLARITY). SEE PAGE 13 FOR FSD WIRE ROUTING DIAGRAM. SEE PAGE 14 FOR F-150 WIRE ROUTING DIAGRAM. 	
FUSE OPTIONS	
F-150 FUSE: POWER 3	FSD FUSE: SNOW PLOW

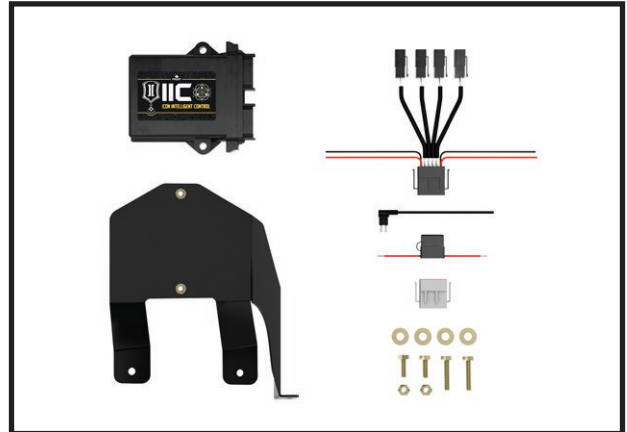

WARNING!

**** READ ALL INSTRUCTIONS THOROUGHLY FROM START TO FINISH BEFORE BEGINNING INSTALLATION! IF THESE INSTRUCTIONS ARE NOT PROPERLY FOLLOWED SEVERE FRAME, SUSPENSION AND TIRE DAMAGE MAY RESULT TO THE VEHICLE!**

**** ICON VEHICLE DYNAMICS RECOMMENDS THAT YOU EXERCISE EXTREME CAUTION WHEN WORKING UNDER A VEHICLE THAT IS SUPPORTED WITH JACK STANDS.**

**** ICON VEHICLE DYNAMICS RECOMMENDS ALL INSTALLATION TO BE PERFORMED BY A PROFESSIONAL SHOP/SERVICE TECHNICIAN. PRODUCT FAILURE CAUSED BY IMPROPER INSTALLATION WILL NOT BE COVERED UNDER ICON'S WARRANTY POLICY.**

17-UP FSD IIC INSTALL KIT INSTALLATION

1. Disconnect the battery using a 10MM.



FIG.1



FIG.2

2. Remove the plastic clip from the cowl. Use the supplied 1/4" hardware (605069, 605053, 605052) through the existing hole to hold the mount in place. Snug the bolt using (2) 7/16" wrenches. [FIGURE 1 & 2]

3. Make sure the bracket is sitting properly against the mounting surfaces and drill the upper bolt hole through the lip of the cowl using a 1/4" drill bit. Use the supplied 1/4" hardware (605054) with nuts and washers to fasten the mount to the cowl. Snug using (2) 7/16 wrenches. Mount the lower tab to the firewall using the supplied self-drilling screw. Tighten hand tight using a 3/8. Torque upper bolts to 50 in-lbs. [FIGURE 3 & 4]

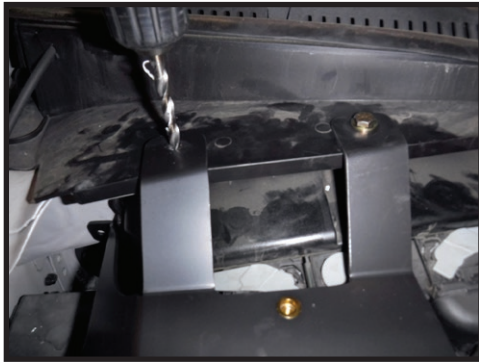

FIG.3



FIG.4

4. Place the adhesive rubber strips (PN: 605984) as shown. Mount the IIC using the supplied bolts (PN: 605069) and torque to 50 in-lbs. [FIGURE 5 & 6]



FIG.5



FIG.6

5. Insert the block off plug in the grey port. Insert the main harness into the black port. [FIGURE 7 & 8]



FIG.7



FIG.8

6. Route the 2 black (GRD) wires down along the side of the battery. Trim as necessary. Strip the wires and crimp the supplied terminal connectors (PN: 605751) on. Activate the heat shrink using a heat gun. Connect the terminal connectors to the ground on the fender using an 8mm. [FIGURE 9]

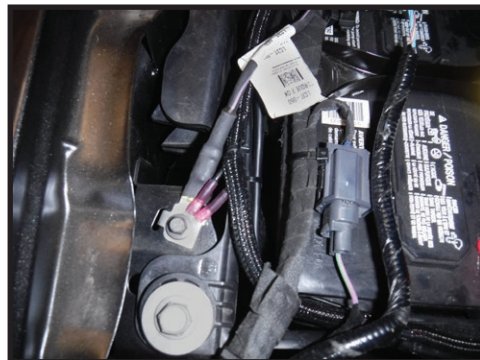

FIG.9

7. Route the Red wire labeled (PWR) to the positive battery terminal. Trim as necessary. Strip the wire and crimp the supplied butt connector (PN: 605750) on. Crimp the supplied inline fuse (PN: 255605-10) to the butt connector. Crimp the supplied terminal connector (PN: 605751) to the inline fuse. Activate the heat shrink using a heat gun. Connect the terminal connector to the battery using a 10mm. PICS: [FIGURE 10 & 11]

FIG.10

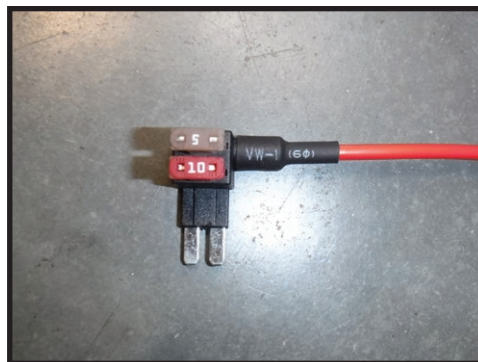

FIG.11



8. Remove the fuse box cover. Look up a diagram of the fuse box and locate the Snow Plow (10A) fuse. Insert the supplied 5A fuse (PN: 605755) in the top slot of the supplied fuse tap (PN: 255608). Remove the Snow Plow (10A) fuse from the fuse box and place in the lower slot of the fuse tap. [FIGURE 12]

FIG.12



9. Insert the fuse tap in the vacant Snow Plow slot of the fuse box. Connect the fuse tap to the red wire labeled (ACC) using the supplied butt connector (PN: 605750). Strip the wires and crimp to the butt connector. Activate heat shrink using a heat gun. Route the wire down to the side of the fuse box and put the cover on. Use supplied wire loom (PN: 605760) to protect wires. [FIGURE 13 & 14]

FIG.13



FIG.14



10. Connect the wires supplied in the shock kits to the main harness.

11. Connect the 14-FT wire (PN: 255604-14) to the Channel-4 plug. Write DF (Driver Front) on both wire plugs with a marker.

12. Connect the 6-FT wire (PN: 255604-06) to the Channel-3 plug. Write PF (Passenger Front) on both wire plugs with a marker.

13. Connect the 20-FT wire (PN: 255604-20) to the Channel-1 plug. Write PR (Passenger Rear) on both wire plugs with a marker.

14. Connect the 30-FT wire (PN: 255604-30) to the Channel-2 plug. Write DR (Driver Rear) on both wire plugs with a marker.

15. Route all 4 wires down next to the battery then down to the frame rail. Use the supplied zip-ties to fasten in place. [FIGURE 15 & 16]

FIG.15



FIG.16



16. At the frame rail, the 6-FT (labeled PF) wire and 20-FT (labeled PR) wire splits off going rearward on top of the frame rail. Plug the 6-FT (labeled PF) wire into the passenger front CDE-Shock solenoid and zip-tie the remaining wire. Be sure to leave some slack in the wire to ensure there is freedom of movement and the ability to unplug the wire from the shock. [FIGURE 17 & 18]

FIG.17



FIG.18



17. Continue routing the 20-FT (labeled PR) wire down the passenger side frame rail following the factory wire loom. [FIGURE 19 & 20]

FIG.19



FIG.20



18. Continue following the wire loom above the frame rail and to the passenger rear shock. Plug the 20-FT (labeled PR) wire into the passenger rear CDE-Shock solenoid and zip-tie the remaining wire. Be sure to leave some slack in the wire to ensure there is freedom of movement and the ability to unplug the wire from the shock. [FIGURE 21]

FIG.21



19. Route the other 2 wires (14-FT & 30-FT) along the crossmember following the factory loom. Carefully route the wires among the factory loom around the steering box pitman arm. [FIGURE 22 & 23]

FIG.22



FIG.23

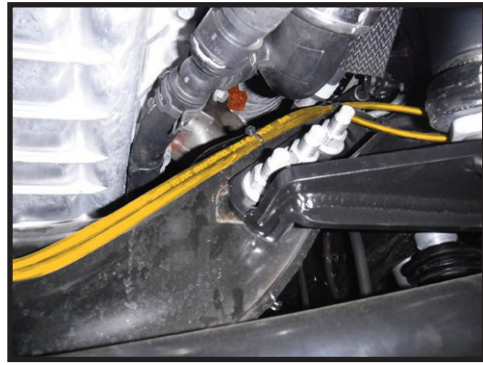

20. The 14-FT wire (labeled DF) splits off. Continue following the factory loom up the inside of the frame rail to the coil bucket. [FIGURE 24 & 25]

FIG.24



FIG.25



21. Plug into the driver front CDE-Shock solenoid and zip-tie the remaining wire. Be sure to leave some slack in the wire to ensure there is freedom of movement and the ability to unplug the wire from the shock. [FIGURE 26]

FIG.26



22. Route the 30-FT (labeled DR) wire to the back of the wheel well and along the factory wire harness. [FIGURE 27 & 28]

FIG.27



FIG.28



23. Follow the factory harness along the frame rail. [FIGURE 29 & 30]

FIG.29



FIG.30



24. Plug into the driver rear CDE-Shock solenoid and zip-tie the remaining wire. Be sure to leave some slack in the wire to ensure there is freedom of movement and the ability to unplug the wire from the shock. [FIGURE 31]

FIG.31



25. Connect the battery using a 10MM.

26. Download the ICON INTELLIGENT CONTROL App on your device. Open the app and turn on the vehicle.

VERIFY ALL FASTENERS ARE PROPERLY TORQUED BEFORE DRIVING VEHICLE.

RETORQUE ALL NUTS, BOLTS AND LUGS AFTER 100 MILES AND PERIODICALLY THEREAFTER.

15-UP F-150 IIC INSTALL KIT INSTALLATION

1. Disconnect the battery using a 10MM.
2. Remove the plastic clip from the cowl. Use the supplied 1/4" hardware (605069, 605053, 605052) through the existing hole to hold the mount in place. Snug the bolt using (2) 7/16" wrenches. [FIGURE 32 & 33]

FIG.32



FIG.33



3. Make sure the bracket is sitting properly against the mounting surfaces and drill the upper bolt hole through the lip of the cowl using a 1/4" drill bit. Use the supplied 1/4" hardware (605054) with nuts and washers to fasten the mount to the cowl. Snug using (2) 7/16" wrenches. Mount the lower tab to the firewall using the supplied self-drilling screw. Tighten hand tight using a 3/8. Torque upper bolts to 50 in-lbs. [FIGURE 34 & 35]

FIG.34

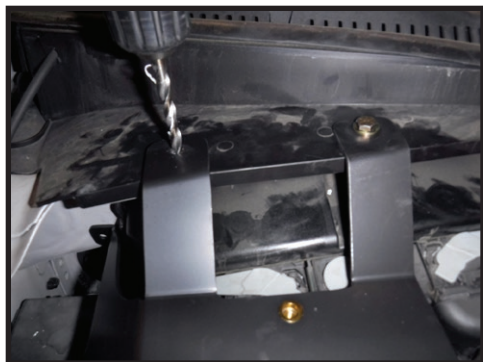

FIG.35



4. Place the adhesive rubber strips (PN: 605984) as shown. Mount the IIC using the supplied bolts 605069 and torque to 50 in-lbs. [FIGURE 36 & 37]

FIG.36



FIG.37



5. Insert the block off plug in the grey port. Insert the main harness into the black port. [FIGURE 38 & 39]

FIG.38



FIG.39



6. Route the 2 black (GRD) wires down along the side of the battery. Trim as necessary. Strip the wires and crimp the supplied terminal connectors (PN: 605751) on. Activate the heat shrink using a heat gun. Connect the terminal connectors to the ground on the fender using an 8mm. [FIGURE 40]

FIG.40



7. Route the Red wire labeled (PWR) to the positive battery terminal. Trim as necessary. Strip the wire and crimp the supplied butt connector (PN: 605750) on. Crimp the supplied inline fuse (PN: 255605-10) to the butt connector. Crimp the supplied terminal connector (PN: 605751) to the inline fuse. Activate the heat shrink using a heat gun. Connect the terminal connector to the battery using a 10mm. [FIGURE 41 & 42]

FIG.41

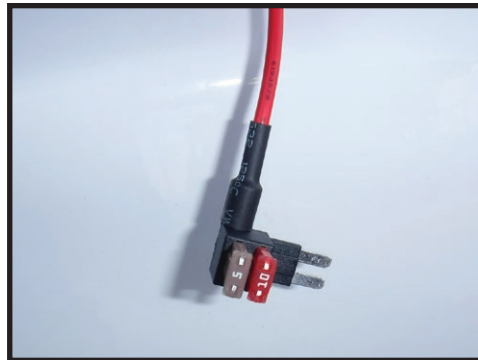

FIG.42



8. Remove the fuse box cover. Look up a diagram of the fuse box and locate the Vehicle Power 3 (10A) fuse. Insert the supplied 5A fuse (PN: 605755) in the top slot of the supplied fuse tap (PN: 255608). Remove the Vehicle Power 3 (10A) fuse from the fuse box and place in the lower slot of the fuse tap. [FIGURE 43]

FIG.43



9. Insert the fuse tap in the vacant Vehicle Power 3 slot of the fuse box. Connect the fuse tap to the red wire labeled (ACC) using the supplied butt connector (PN: 605750). Strip the wires and crimp to the butt connector. Activate heat shrink using a heat gun. Route the wire down to the side of the fuse box and put the cover on. Use supplied wire loom (PN: 605760) to protect wires. [FIGURE 44 & 45]

FIG.44



FIG.45



10. Connect the wires supplied in the shock kits to the main harness.
11. Connect the 8-FT wire (PN: 255604-08) to the Channel-4 plug. Write DF (Driver Front) on both wire plugs with a marker.
12. Connect the 6-FT wire (PN: 255604-06) to the Channel-3 plug. Write PF (Passenger Front) on both wire plugs with a marker.
13. Connect the 26-FT wire (PN: 255604-26) to the Channel-1 plug. Write PR (Passenger Rear) on both wire plugs with a marker.
14. Connect the 26-FT wire (PN: 255604-26) to the Channel-2 plug. Write DR (Driver Rear) on both wire plugs with a marker.
15. Route the wires down next to the battery then down to the front crossmember. Use the supplied zip-ties to fasten in place. Route the wires along the factory wire loom. [FIGURE 46 & 47]

FIG.46



FIG.47



16. At the crossmember, the 6-FT (labeled PF) wire splits off. Plug into the passenger front CDE-Shock solenoid and zip-tie the remaining wire. Be sure to leave some slack in the wire to ensure there is freedom of movement and the ability to unplug the wire from the shock. [FIGURE 48 & 49]

FIG.48



FIG.49

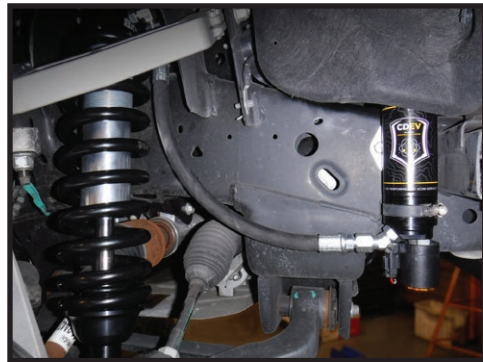

17. Route the 3 wires along the crossmember following the factory loom. At the driver side frame rail. The 8-FT wire (labeled DF) splits off. Plug into the driver front CDE-Shock solenoid and zip-tie the remaining wire. Be sure to leave some slack in the wire to ensure there is freedom of movement and the ability to unplug the wire from the shock. [FIGURE 50 & 51]

FIG.50



FIG.51



18. Route the 2 wires up the inside of the frame rail and over the shock bucket following the factory loom. [FIGURE 52 & 53]

FIG.52

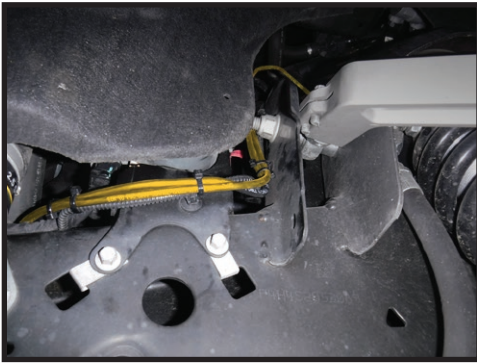
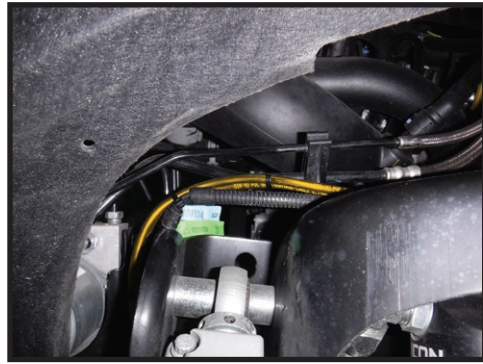

FIG.53



19. Route the wires to the back of the wheel well and along the factory wire harness. [FIGURE 54 & 55]

FIG.54



FIG.55

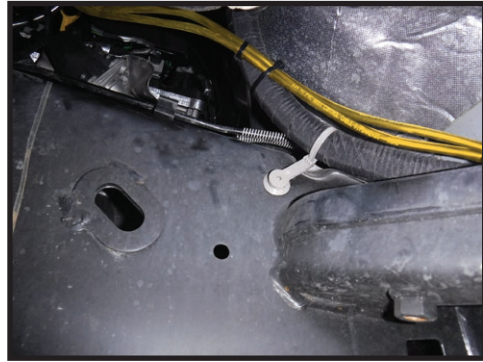

20. Follow the factory harness and brake lines along the frame rail. [FIGURE 56, 57 & 58]

FIG.56



FIG.57



FIG.58



21. At the crossmember above the back of the gas tank, the wires separate. The 26-FT wire (labeled DR) continues along the driver side frame rail, then crosses over the top of the frame rail at the spare tire. [FIGURE 59 & 60]

FIG.59



FIG.60



22. Plug into the driver rear CDE-Shock solenoid and zip-tie the remaining wire. Be sure to leave some slack in the wire to ensure there is freedom of movement and the ability to unplug the wire from the shock. Drill a 1/4" hole in the side of the shock mount and zip tie the wire to the shock mount using the drilled hole. [FIGURE 61 & 62]

FIG.61



FIG.62



23. Route the 26-FT wire (labeled PR) across the crossmember at the back of the gas tank. Plug into the passenger rear CDE-Shock solenoid and zip-tie the remaining wire. Be sure to leave some slack in the wire to ensure there is freedom of movement and the ability to unplug the wire from the shock. [FIGURE 63 & 64]

FIG.63



FIG.64



24. Connect the battery using a 10MM.

25. Download the ICON INTELLIGENT CONTROL App on your device. Open the app and turn on the vehicle.

VERIFY ALL FASTENERS ARE PROPERLY TORQUED BEFORE DRIVING VEHICLE.

RETORQUE ALL NUTS, BOLTS AND LUGS AFTER 100 MILES AND PERIODICALLY THEREAFTER.

ICON VEHICLE DYNAMICS LIMITED LIFETIME WARRANTY

ICON Vehicle Dynamics warrants to the original retail purchaser who owns the vehicle on which the product was originally installed. ICON Vehicle Dynamics does not warrant the product for finish, alterations, modifications and/or installation contrary to ICON Vehicle Dynamics instructions. ICON Vehicle Dynamics products are not designed, nor are they intended to be installed on vehicles used in race applications, for racing purposes or for similar activities. (A "race" is defined as any contest between two or more vehicles, or a contest of one or more vehicles against the clock, whether or not such contest is for a prize). This warranty does not include coverage for police or taxi vehicles, race vehicles, or vehicles used for government or commercial purposes. Also excluded from this warranty are sales outside of the United States of America and Canada.

ICON Vehicle Dynamics' obligation under this warranty is limited to the repair or replacement, at ICON Vehicle Dynamics' discretion, of the defective product. Any and all costs of removal, installation or re-installation, freight charges and incidental or consequential damages are expressly excluded from this warranty. Items that are subject to wear are not considered defective when worn and are not covered.

ICON Vehicle Dynamics components must be installed as a complete kit as shown in our current application guide. Any substitutions or exemptions of required components will immediately void the warranty. Some finish damage may happen to parts during shipping and is not covered under warranty.

This warranty is expressly in lieu of all other warranties expressed or implied. This warranty shall not apply to any product that has been improperly installed, modified or customized subject to accident, negligence, abuse or misuse.



ICON VEHICLE DYNAMICS®
PERFORMANCE SUSPENSION SYSTEMS AND SHOCK ABSORBERS

7929 Lincoln Ave. Riverside, CA 92504 Phone: 951.689.ICON Fax: 951.689.1016
www.iconvehicledynamics.com



FOLLOW US ON FACEBOOK!



WIRE ROUTING DIAGRAM: FSD

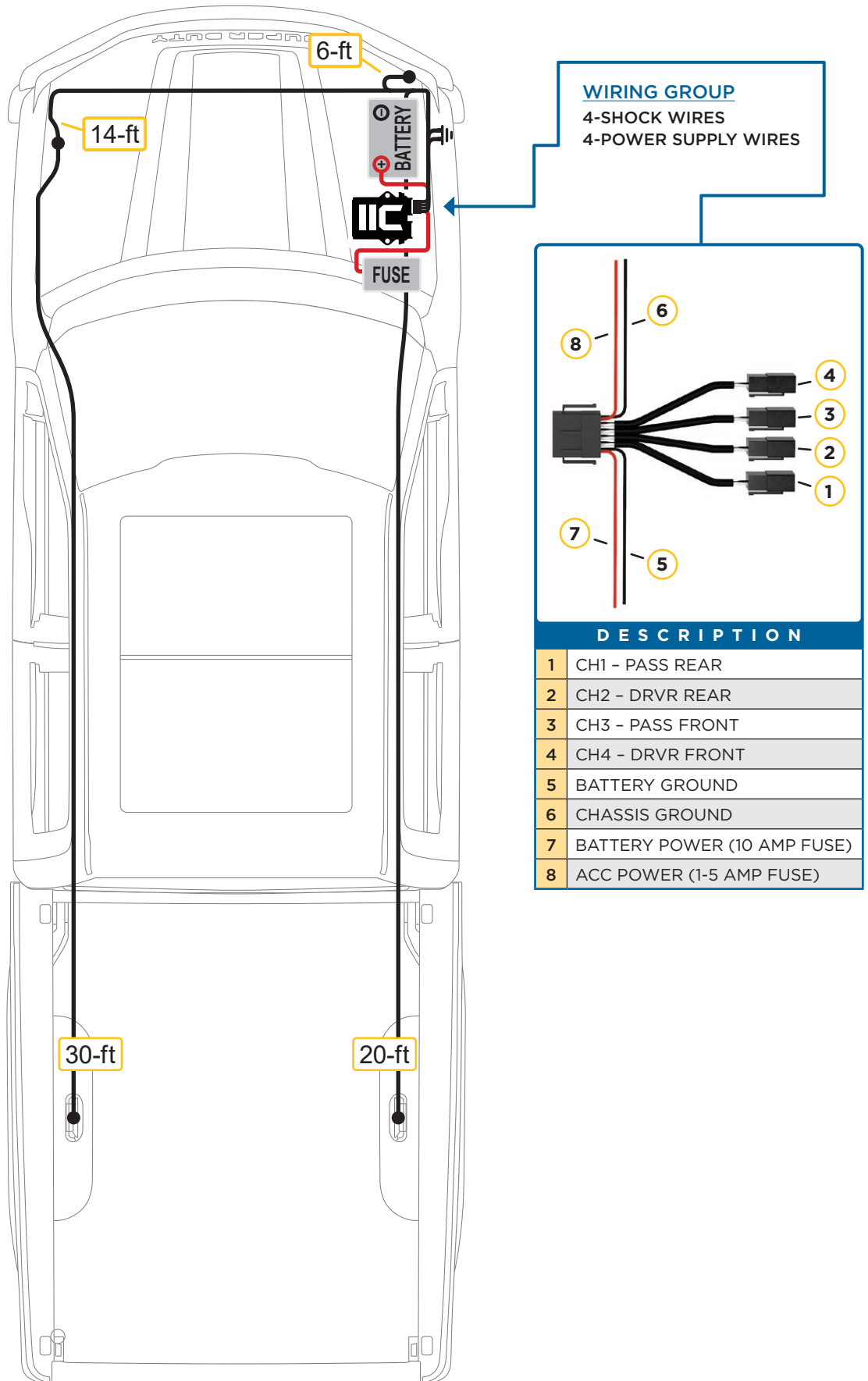

WIRE ROUTING DIAGRAM: F-150

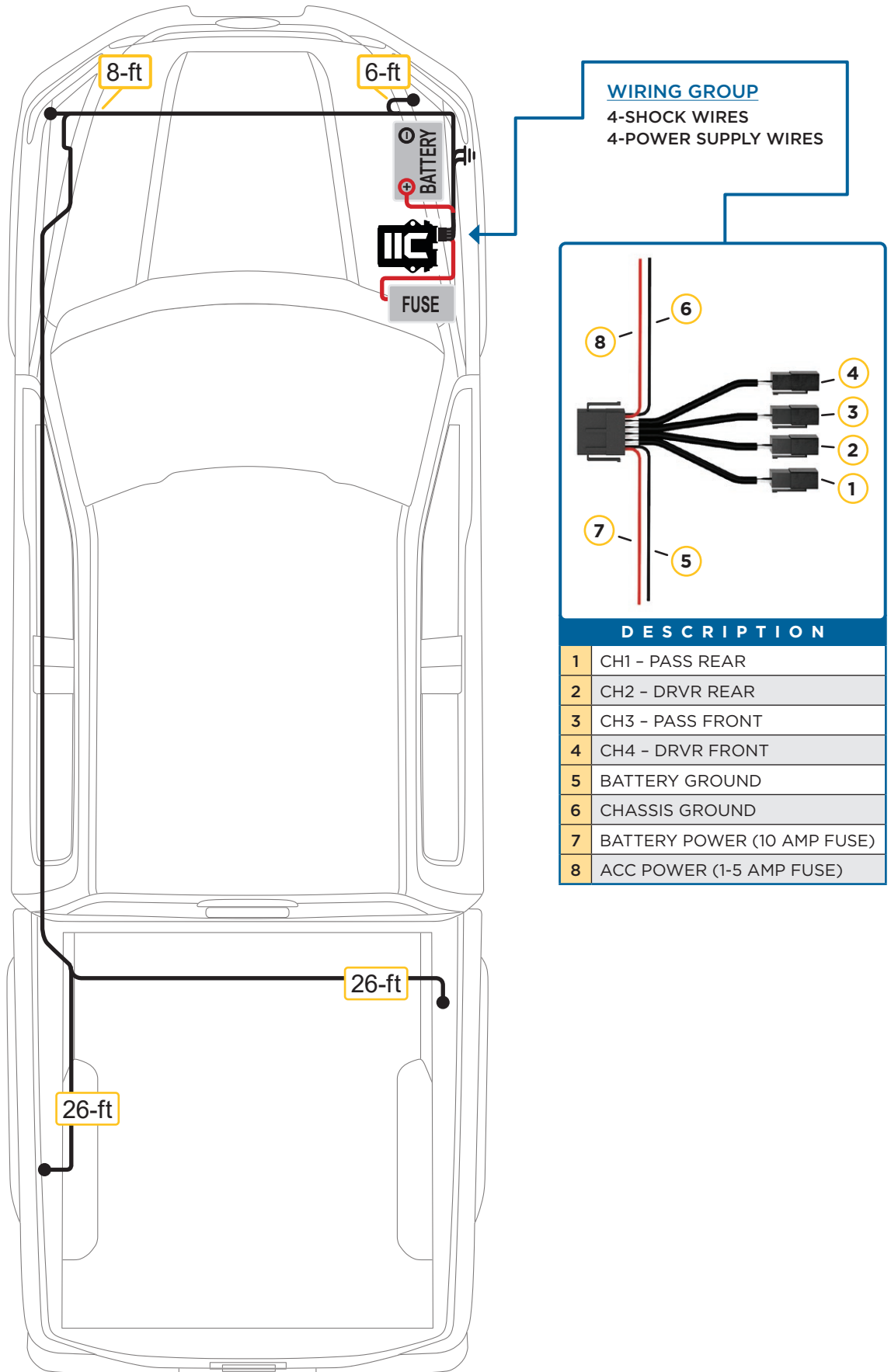

7929 Lincoln Ave. Riverside, CA 92504
Phone: 951.689.ICON | Fax: 951.689.1016

PART #	DESCRIPTION
94000	21-23 F150 4WD FRONT KNUCKLE KIT

COMPONENTS INCLUDED	
(1) 197060D 21 F150 4WD LIFTED STEERING KNUCKLE DRVR	(1) 197060P 21 F150 4WD LIFTED STEERING KNUCKLE PASS
HARDWARE INCLUDED	
(1) 605969 VIBRATITE RED 2ML BULLET	
TOOLS REQUIRED	
JACK JACK STAND RATCHET EXTENSIONS TORQUE WRENCH HAMMER / DEADBLOW HAMMER BALL JOINT SEPERATOR	T45 TORX 5MM HEX KEY 8MM SOCKET / WRENCH 10MM SOCKET / WRENCH 13MM SOCKET / WRENCH 18MM SOCKET / WRENCH 21MM SOCKET / WRENCH 36MM SOCKET / WRENCH
TECH NOTES	
<ol style="list-style-type: none"> ESTIMATED INSTALL TIME: 3-4 HOURS 4WD EQUIPPED VEHICLES ONLY WILL NOT WORK ON CCD EQUIPPED TRUCKS MUST USE ICON UPPER CONTROL ARM: #98522DJ ALL OEM HARDWARE FROM THE KNUCKLE REMOVAL WILL BE REUSED ON THE ICON KNUCKLE. 	



WARNING!
<p>** READ ALL INSTRUCTIONS THOROUGHLY FROM START TO FINISH BEFORE BEGINNING INSTALLATION! IF THESE INSTRUCTIONS ARE NOT PROPERLY FOLLOWED SEVERE FRAME, SUSPENSION AND TIRE DAMAGE MAY RESULT TO THE VEHICLE!</p> <p>** ICON VEHICLE DYNAMICS RECOMMENDS THAT YOU EXERCISE EXTREME CAUTION WHEN WORKING UNDER A VEHICLE THAT IS SUPPORTED WITH JACK STANDS.</p> <p>** ICON VEHICLE DYNAMICS RECOMMENDS ALL INSTALLATION TO BE PERFORMED BY A PROFESSIONAL SHOP/SERVICE TECHNICIAN. PRODUCT FAILURE CAUSED BY IMPROPER INSTALLATION WILL NOT BE COVERED UNDER ICON'S WARRANTY POLICY.</p>

INSTALLATION

- Lift vehicle and securely place heavy duty jack stands under the manufacturer recommended lifting locations for the front of the vehicle. Take care when lifting the vehicle, and allow 3-4" of ground clearance from the tire. NEVER WORK UNDER AN UNSUPPORTED VEHICLE. Remove the wheels/tires.
- Begin by removing the sway bar link from the upper part of the knuckle using a T45 torx and 21mm wrench. [FIGURE 1]

FIG.1



3. Next, remove the ABS and brake line bracket from the knuckle using a 10mm. [FIGURE 2]

FIG.2



4. Remove the brake caliper from the knuckle using a 21mm. Once removed, use a wire hanger or string to support the caliper so it does not hang by the brake line. Remove the rotor and set it aside. [FIGURE 3 & 4]

FIG.3



FIG.4

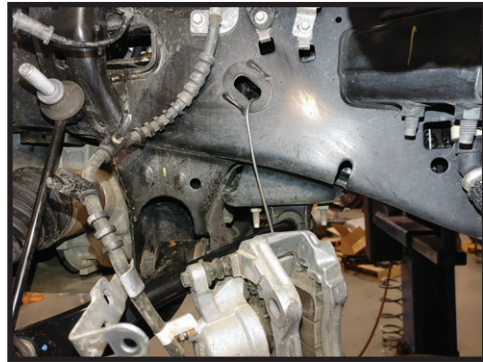

5. Remove the 3 bolts holding the rotor rock shield from the knuckle using an 8mm. [FIGURE 5 & 6]

FIG.5

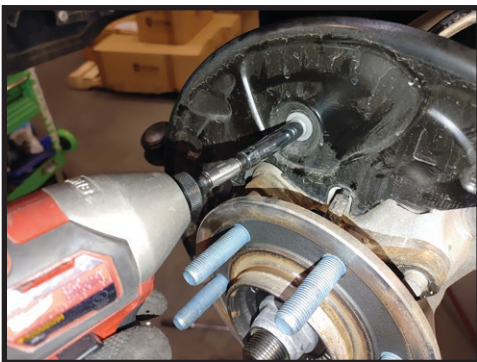

FIG.6



6. Remove the speed sensor from the top side of the knuckle, behind the rock shield using a 5mm hex key. [FIGURE 7]

FIG.7



7. Remove the CV axle nut from the hub. Depending on the hub style of your truck, it will be a 13mm or a 36mm socket. If the truck is equipped with electric hubs, also, remove the 4x 8mm bolts from the backside of the knuckle. This will allow the locking portion to be removed with the CV axle shaft. [FIGURE 8, 9 & 10]

FIG.8

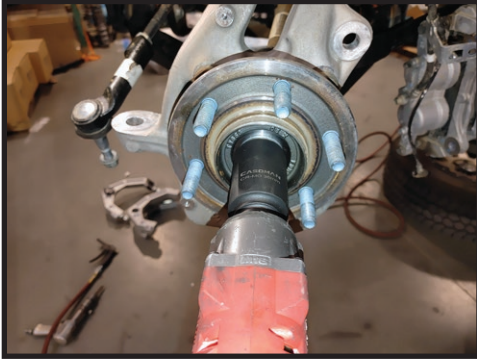

FIG.9

FIG.10



8. Next, loosen the upper balljoint nut using a 18mm. Leave the nut loosely installed. Use a ball joint separator to dislodge the ball joint stud from the knuckle. A hammer can also be used by striking the side of the knuckle. [FIGURE 11 & 12]

FIG.11

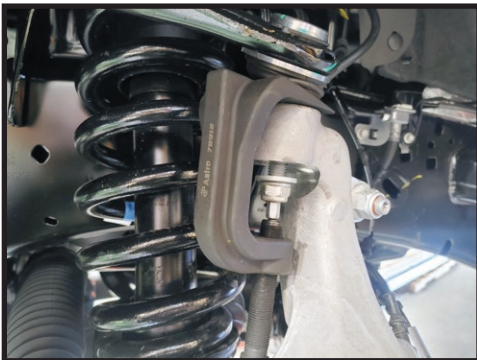

FIG.12



9. Repeat this process on the lower ball joint. Use a 24mm to loosen the nut. [FIGURE 13]

FIG.13



10. The knuckle can now be removed. The upper control arm might be under pressure, take caution when removing the nut. Tilt the arm out and remove the CV axle from the hub, a dead blow hammer can be used to persuade it. Now remove the lower ball joint nut and set the knuckle down.

11. With the knuckle out of the vehicle, the hub can be removed and transfer to the new ICON knuckle, using an 18mm.
[FIGURE 14 & 15]

FIG.14

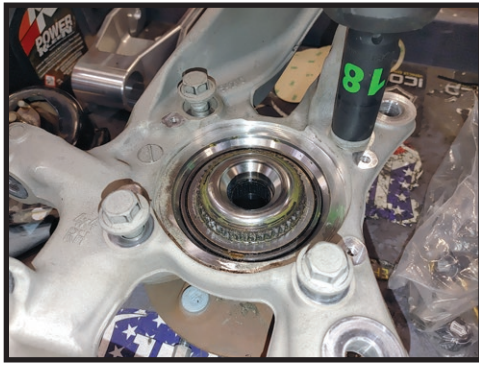
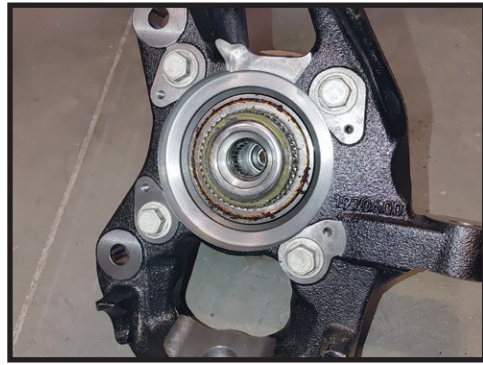

FIG.15



12. Move on to the coilover and upper control arm instructions now. Some steps might be redundant.

13. With the ICON coilover and upper control arm installed, the ICON knuckle can be reinstalled in the reverse order of removal of the OEM knuckle. Be sure to torque all bolts to OEM spec. Red thread locker should be used on the hub and brake caliper bolts and CV axle nut.

VERIFY ALL FASTENERS ARE PROPERLY TORQUED BEFORE DRIVING VEHICLE.

RETORQUE ALL NUTS, BOLTS AND LUGS AFTER 100 MILES AND PERIODICALLY THEREAFTER.

ICON VEHICLE DYNAMICS LIMITED LIFETIME WARRANTY

ICON Vehicle Dynamics warrants to the original retail purchaser who owns the vehicle on which the product was originally installed. ICON Vehicle Dynamics does not warrant the product for finish, alterations, modifications and/or installation contrary to ICON Vehicle Dynamics instructions. ICON Vehicle Dynamics products are not designed, nor are they intended to be installed on vehicles used in race applications, for racing purposes or for similar activities. (A "race" is defined as any contest between two or more vehicles, or a contest of one or more vehicles against the clock, whether or not such contest is for a prize). This warranty does not include coverage for police or taxi vehicles, race vehicles, or vehicles used for government or commercial purposes. Also excluded from this warranty are sales outside of the United States of America and Canada.

ICON Vehicle Dynamics' obligation under this warranty is limited to the repair or replacement, at ICON Vehicle Dynamics' discretion, of the defective product. Any and all costs of removal, installation or re-installation, freight charges and incidental or consequential damages are expressly excluded from this warranty. Items that are subject to wear are not considered defective when worn and are not covered.

ICON Vehicle Dynamics components must be installed as a complete kit as shown in our current application guide. Any substitutions or exemptions of required components will immediately void the warranty. Some finish damage may happen to parts during shipping and is not covered under warranty.

This warranty is expressly in lieu of all other warranties expressed or implied. This warranty shall not apply to any product that has been improperly installed, modified or customized subject to accident, negligence, abuse or misuse.



7929 Lincoln Ave. Riverside, CA 92504 Phone: 951.689.ICON Fax: 951.689.1016
www.iconvehicledynamics.com



FOLLOW US ON FACEBOOK!



7929 Lincoln Ave. Riverside, CA 92504
Phone: 951.689.ICON | Fax: 951.689.1016

PART #	DESCRIPTION
97721EP	21-23 F150 4WD TREMOR REAR 2.5 AL VS PB CDEV PAIR

COMPONENTS INCLUDED	
(2) 194801E-AL 21-23 F150 4WD TREMOR REAR 2.5 AL VS PB CDEV UPKG	
HARDWARE INCLUDED	
(8) 257164 HEIM SPACER COM10 SPACER X .500 X 1.500 CZINC	(2) 255604-26 EXTENSION HARNESS COIL 26 FT
TOOLS REQUIRED	
JACK JACK STANDS PRY BAR TORQUE WRENCH	15MM SOCKET / WRENCH 18MM SOCKET / WRENCH
TECH NOTES	
<p>1. ESTIMATED INSTALL TIME: 1-2 HOURS,</p> <p>2. YOUR ICON SHOCK ASSEMBLIES COME FACTORY CHARGED TO 150 PSI. RELEASING NITROGEN PRESSURE MAY LEAD TO SHOCK MALFUNCTION AND REDUCED RIDE QUALITY. FAILURE CAUSED BY LOW NITROGEN PRESSURE IS NOT COVERED UNDER ICON'S WARRANTY POLICY.</p>	



WARNING!

**** READ ALL INSTRUCTIONS THOROUGHLY FROM START TO FINISH BEFORE BEGINNING INSTALLATION! IF THESE INSTRUCTIONS ARE NOT PROPERLY FOLLOWED SEVERE FRAME, SUSPENSION AND TIRE DAMAGE MAY RESULT TO THE VEHICLE!**

**** ICON VEHICLE DYNAMICS RECOMMENDS THAT YOU EXERCISE EXTREME CAUTION WHEN WORKING UNDER A VEHICLE THAT IS SUPPORTED WITH JACK STANDS.**

**** ICON VEHICLE DYNAMICS RECOMMENDS ALL INSTALLATION TO BE PERFORMED BY A PROFESSIONAL SHOP/SERVICE TECHNICIAN. PRODUCT FAILURE CAUSED BY IMPROPER INSTALLATION WILL NOT BE COVERED UNDER ICON'S WARRANTY POLICY.**

INSTALLATION

1. Using a properly rated jack, raise the rear of the vehicle and support the frame rails with jack stands. Ensure the jack stands are secure and set properly before lowering the jack. NEVER WORK UNDER AN UNSUPPORTED VEHICLE.



FIG.1

2.

2. Remove the factory rear shocks using a 15mm and an 18mm socket/wrench. [FIGURE 1]

3. The passenger side upper shock mount needs to be sanded slightly in order for the ICON shock to fit. [FIGURE 2 & 3]

FIG.2

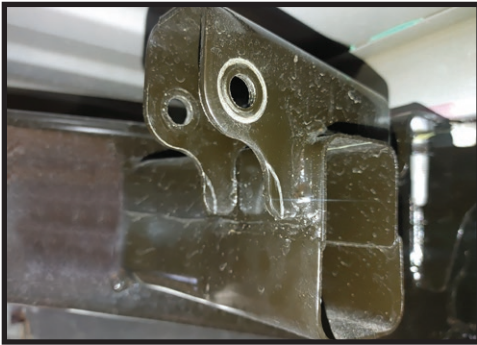
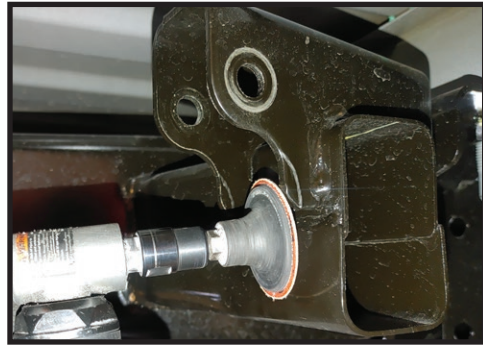

FIG.3



4. Paint all exposed metal to prevent rust.

5. Install the ICON rear shocks using a 15mm and an 18mm socket/wrench. The reservoir points away from the axle. [Torque to factory spec] [FIGURE 4 & 5]

FIG.4



FIG.5



6. Reinstall wheels and tires. Get vehicle professionally aligned if coilovers or spacers were installed on the front.

7. Refer to IIC install instructions for wiring and routing information.

***VERIFY ALL FASTENERS ARE PROPERLY TORQUED BEFORE DRIVING VEHICLE.
RETORQUE ALL NUTS, BOLTS AND LUGS AFTER 100 MILES AND PERIODICALLY THEREAFTER.***

2.5 VS SERIES SHOCK & COILOVER TECHNICAL INFORMATION

MAINTENANCE

ICON shock absorbers are a high quality rebuildable race style shock absorber designed for optimal performance. With a unit of this caliber on your vehicle, routine maintenance is required to keep them looking and operating in like new condition. Residual oil and assembly lube may be present at all seal paths from the factory out of the box and is considered normal. Pooling of oil however is not acceptable at any time and one should contact the ICON dealer where purchased.

BELOW ARE GUIDELINES BASED ON HOW YOU USE YOUR VEHICLE BUT YOUR MILEAGE MAY VARY:

STREET USE:

- Send in for factory servicing every 40,000 miles or if a leak develops, ride quality decreases, or they begin to make excessive noise.
- Remove any buildup of road salt, mud, or debris from shocks and coil springs anytime accrued
- Clean with mild soap and water with each oil change or anytime you notice build up.
- Wax the cylinders yearly with automotive wax to prevent corrosion.
- Check nitrogen pressure yearly. (252004 charge needle assembly available at any ICON distributor)
- Check bearings for excessive wear yearly.
- DO NOT apply any type of lube to the upper and lower bearings.

STREET/DIRT:

- Send in for factory servicing every 15,000 miles or if a leak develops, ride quality decreases, or they begin to make excessive noise.
- Clean with mild soap and water with each oil change, offroad trip, or anytime you notice build up.
- Wax the cylinders yearly with automotive wax to prevent corrosion.
- Check nitrogen pressure each dirt outing. (252004 charge needle assembly available at any ICON distributor)
- Check bearings for excessive wear yearly.
- DO NOT apply any type of lube to the upper and lower bearings.

DIRT USE:

- Send in for factory servicing every 1,000 miles.
- Check nitrogen pressure each outing. (252004 charge needle assembly available at any ICON distributor)
- Remove any buildup of mud or debris from shocks and coil springs after every outing.

SELF-SERVICE:

- Contact ICON for service kits & tools at (951) 689-4266.

PRODUCT REGISTRATION

Please visit: <http://www.iconvehicledynamics.com/tech-support/registration/> to register your product.

ICON VEHICLE DYNAMICS SHOCK ABSORBER WARRANTY

This shock absorber has a 1 year warranty against any manufacturer's defects. If a shock fails within the initial year of ownership, the shock must be shipped to ICON Vehicle Dynamics for inspection and service. If a shock is inspected and it has been determined the shock failed due to neglect, damage caused by improper installation or any other reason besides "normal wear and tear", the owner of said shock is responsible for all service costs. This includes labor, parts, and shipping.

ICON Vehicle Dynamics warrants to the original retail purchaser who owns the vehicle on which the product was originally installed. ICON Vehicle Dynamics does not warrant the product for finish, alterations, modifications and/or installation contrary to ICON Vehicle Dynamics instructions. ICON Vehicle Dynamics products are not designed, nor are they intended to be installed on vehicles used in race applications, for racing purposes or for similar activities. (A "race" is defined as any contest between two or more vehicles, or a contest of one or more vehicles against the clock, whether or not such contest is for a prize). This warranty does not include coverage for police or taxi vehicles, race vehicles, or vehicles used for government or commercial purposes. Also excluded from this warranty are sales outside of the United States of America and Canada.

ICON Vehicle Dynamics' obligation under this warranty is limited to the repair or replacement, at ICON Vehicle Dynamics' discretion, of the defective product. Any and all costs of removal, installation or re-installation, freight charges and incidental or consequential damages are expressly excluded from this warranty. Items that are subject to wear are not considered defective when worn and are not covered.

ICON Vehicle Dynamics components must be installed as a complete kit as shown in our current application guide. Any substitutions or exemptions of required components will immediately void the warranty. Some finish damage may happen to parts during shipping and is not covered under warranty.

This warranty is expressly in lieu of all other warranties expressed or implied. This warranty shall not apply to any product that has been improperly installed, modified or customized subject to accident, negligence, abuse or misuse.

To send a shock in for warranty please visit our website <http://www.iconvehicledynamics.com/tech-support/shock-service/>



ICON VEHICLE DYNAMICS®
PERFORMANCE SUSPENSION SYSTEMS AND SHOCK ABSORBERS

7929 Lincoln Ave. Riverside, CA 92504 Phone: 951.689.ICON Fax: 951.689.1016
www.iconvehicledynamics.com



FOLLOW US ON FACEBOOK!



7929 Lincoln Ave. Riverside, CA 92504
Phone: 951.689.ICON | Fax: 951.689.1016

PART #	DESCRIPTION
98523DJ	21-23 F150 BILLET UCA DJ PRO KIT

COMPONENTS INCLUDED	
(1) 197521 21 F150 BILLET UCA DRVR DJ PRO	(1) 197522 21 F150 BILLET UCA PASS DJ PRO
HARDWARE INCLUDED	
(4) 157520 L-R ADJ SLEEVE 1.00-14L / .75-16 (2) 177158DJ 21-23 F150 DELTA JOINT PRO (4) 197502 HEIM SPACER RSMX12 X 14MM X 2.125 CZINC (4) 197503 HEIM SPACER RSMX12 X 14MM X 2.775 CZINC (4) 295511 ROD END JM12T F1 FIT	(2) 295570 RETAINING RING WHT-237 SS (2) 295571 -035 O-RING (2) 297165 DELTA PRO BILLET UCA DUST COVER (8) 605002 6-32 X .500 SHCS 18-8 (8) 605145 3/8-16 X 1.000 12PT (1) 605968 BLUE THREAD LOCKER 2ML BULLET
TOOLS REQUIRED	
JACK JACK STANDS TORQUE WRENCH 10MM SOCKET / WRENCH 18MM SOCKET / WRENCH	21MM SOCKET / WRENCH 27MM SOCKET / WRENCH 9/16" SOCKET / WRENCH 5/8" SOCKET / WRENCH T45 TORX
TECH NOTES	
<p>1. ALL ICON UPPER CONTROL ARMS HAVE BEEN ENGINEERED TO ALLOW FOR THE MOST POSSIBLE CASTER, WHILE STILL ALLOWING THE VEHICLE TO BE PROPERLY ALIGNED. NOTIFY YOUR PROFESSIONAL ALIGNMENT SHOP OF THIS INFORMATION SO THAT MAXIMUM RIDE QUALITY CAN BE ACHIEVED.</p> <p>2. ICON DELTA JOINTS ARE PRE-GREASED FROM THE FACTORY. ICON RECOMMENDS GREASING THE DELTA JOINT EVERY 3,000 MILES (OR EVERY OIL CHANGE). ADD NEW GREASE UNTIL ALL OF THE OLD GREASE IS EXPELLED FROM THE BOTTOM OF THE DELTA JOINT ASSEMBLY, WIPE AWAY EXCESS WITH A RAG OR SHOP TOWEL.</p> <p>3. DO NOT EXCEED 1.875" ADJUSTMENT FROM THE CENTER OF THE ROD END TO THE EDGE OF THE BILLET UPPER CONTROL ARM. FAILURE CAUSED BY EXCESSIVE ADJUSTMENT WILL NOT BE COVERED UNDER ICON'S WARRANTY POLICY. REFER TO TECH NOTE #3 PHOTO ON PAGE 5.</p>	

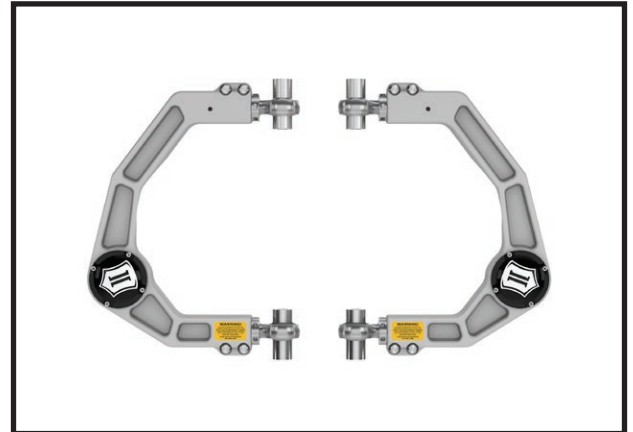

WARNING!
<p>** READ ALL INSTRUCTIONS THOROUGHLY FROM START TO FINISH BEFORE BEGINNING INSTALLATION! IF THESE INSTRUCTIONS ARE NOT PROPERLY FOLLOWED SEVERE FRAME, SUSPENSION AND TIRE DAMAGE MAY RESULT TO THE VEHICLE!</p> <p>** ICON VEHICLE DYNAMICS RECOMMENDS THAT YOU EXERCISE EXTREME CAUTION WHEN WORKING UNDER A VEHICLE THAT IS SUPPORTED WITH JACK STANDS.</p> <p>** ICON VEHICLE DYNAMICS RECOMMENDS ALL INSTALLATION TO BE PERFORMED BY A PROFESSIONAL SHOP/SERVICE TECHNICIAN. PRODUCT FAILURE CAUSED BY IMPROPER INSTALLATION WILL NOT BE COVERED UNDER ICON'S WARRANTY POLICY.</p>

INSTALLATION

- Using a properly rated jack, raise the front of the vehicle and support the frame rails with jack stands. Ensure the jack stands are secure and set properly before lowering the jack. NEVER WORK UNDER AN UNSUPPORTED VEHICLE. Remove the front wheels.
- Remove the coilover/strut assembly to gain access to the upper control arm bolts.
- Remove the 2 nuts from the lower shock mount using an 18mm socket/wrench (5/8" on ICON coilover).
- Support the spindle with a jack or strap and remove the lower control arm bolts from the frame using a 27 and 21mm socket/wrench. This will allow you to separate the lower arm and lower shock studs. [FIGURE 1]

FIG.1



- If you prefer to leave the lower arm in place, use a hammer to press the studs out of the lower bar pin assembly.
 - If ICON coilover is already installed, you do not need to remove the lower control arm from the frame.
- Disconnect the tie rod from the knuckle using a 21mm and 10mm wrench.

6. Remove the 3 nuts from the top of the factory shock assembly with an 18mm socket/wrench (9/16" for ICON coilover). The coilover can then be removed completely. [FIGURE 2]

FIG.2



7. If the lower arm was removed, Reinstall it now, only snugging the bolts in place (They will be torqued at the end).

8. If truck is equipped with Dynamic Bending Headlamps (Automatic ride height adjusting headlights) you will need to remove the bracket. Use a flat blade screwdriver or pry bar to carefully pop the socket off the ball. [FIGURE 3]

FIG.3



9. Remove the sway-bar link and upper control arm from the spindle. Support spindle with a jack or strap to prevent the CV (4x4) or brake lines from over extending (18mm, 21mm, T45 Torx). [FIGURE 4]

FIG.4



10. Remove the UCA from the frame using a 21mm and 18mm socket/wrench.

11. The spacers are installed as pictured, Narrow spacers go towards the coilover. Wide spacers go away from the coilover. [FIGURE 5]

FIG.5

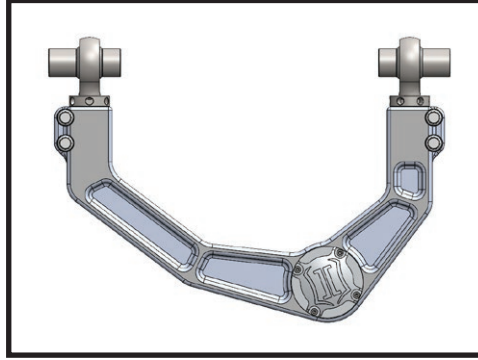

12. If truck is equipped with Dynamic Bending Headlamps (automatic height adjusting headlights) you will need to install the bracket (sold separately) on the driver side billet UCA or the factory ball stud on the tube UCA. The factory ball stud takes a 8mm and 11mm wrench. [FIGURE 6]

FIG.6

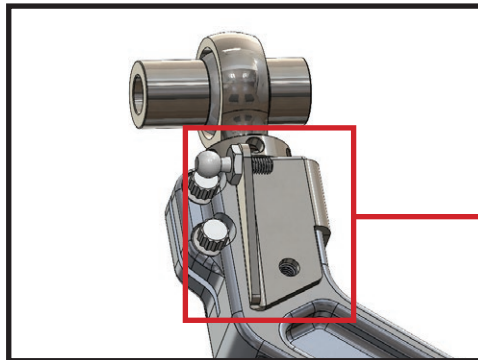

*BILLET UCA
WITH BRACKET*

13. If equipped with the Continuous Control Damping (CCD) or Dynamic Bending Headlamps, the bracket on the frame will need to be removed and moved down 3/4". Remove 11mm bolt that holds the bracket onto the frame. [FIGURE 7]

FIG.7

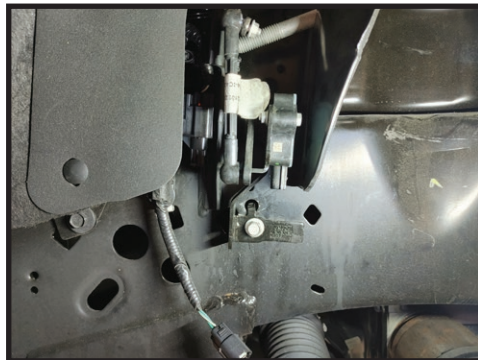

14. Use a screwdriver to lift the clip nut and relocate it down 3/4". Mark the center of the hole and drill it out to 1/2". [FIGURE 8, 9, 10]

FIG.8

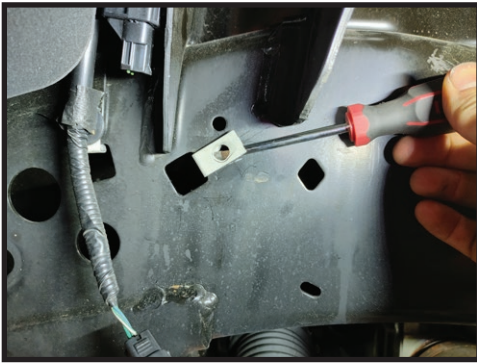

FIG.9

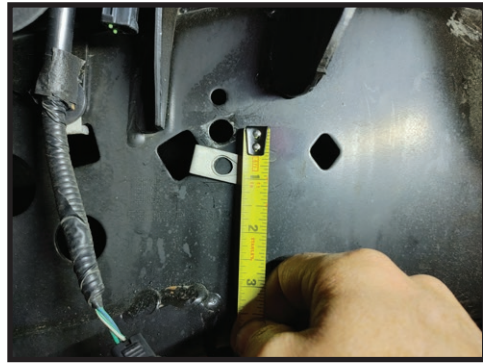
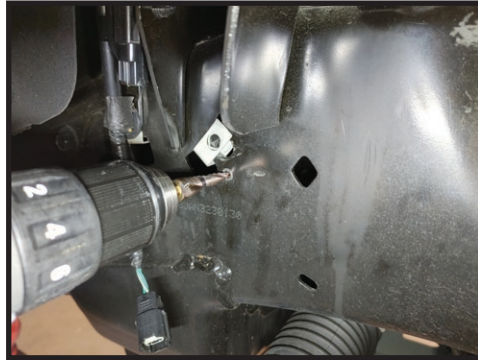
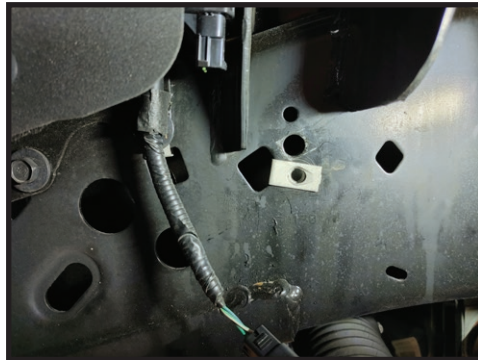

FIG.10



15. Place clip nut into the new hole. [FIGURE 11]

FIG.11



16. Install the bracket and sensor tab into the old bolt hole and use the factory hardware to secure it into the new location.

17. Place the ICON upper control arm into the mounts on the chassis and hand tighten using OEM hardware.

18. Reinstall OEM shock or refer to ICON coil over assembly instructions now.

19. Install tapered pin of UCA into the spindle and tighten using the supplied nut and 18mm socket/wrench. [Torque to 75 ft-lbs] [FIGURE 12]

FIG.12



20. Tighten the UCA bolts at the chassis using a 21mm and 18mm socket/wrench. [Torque to factory spec]
21. Install the Delta Joint dust cap and o-ring using the 4 socket head screws.
22. Repeat steps on opposite side.
23. Reinstall wheels and carefully lower vehicle to the ground. [Torque lug nuts to factory spec]
24. If the lower control arm was removed, now is the time to tighten the frame bolts. [Torque to factory spec]
25. Have the vehicle professionally aligned.



[TECH NOTE #3]

VERIFY ALL FASTENERS ARE PROPERLY TORQUED BEFORE DRIVING VEHICLE.

RETORQUE ALL NUTS, BOLTS AND LUGS AFTER 100 MILES AND PERIODICALLY THEREAFTER.

ICON VEHICLE DYNAMICS LIMITED LIFETIME WARRANTY

ICON Vehicle Dynamics warrants to the original retail purchaser who owns the vehicle on which the product was originally installed. ICON Vehicle Dynamics does not warrant the product for finish, alterations, modifications and/or installation contrary to ICON Vehicle Dynamics instructions. ICON Vehicle Dynamics products are not designed, nor are they intended to be installed on vehicles used in race applications, for racing purposes or for similar activities. (A "race" is defined as any contest between two or more vehicles, or a contest of one or more vehicles against the clock, whether or not such contest is for a prize). This warranty does not include coverage for police or taxi vehicles, race vehicles, or vehicles used for government or commercial purposes. Also excluded from this warranty are sales outside of the United States of America and Canada.

ICON Vehicle Dynamics' obligation under this warranty is limited to the repair or replacement, at ICON Vehicle Dynamics' discretion, of the defective product. Any and all costs of removal, installation or re-installation, freight charges and incidental or consequential damages are expressly excluded from this warranty. Items that are subject to wear are not considered defective when worn and are not covered.

ICON Vehicle Dynamics components must be installed as a complete kit as shown in our current application guide. Any substitutions or exemptions of required components will immediately void the warranty. Some finish damage may happen to parts during shipping and is not covered under warranty.

This warranty is expressly in lieu of all other warranties expressed or implied. This warranty shall not apply to any product that has been improperly installed, modified or customized subject to accident, negligence, abuse or misuse.



ICON VEHICLE DYNAMICS®
PERFORMANCE SUSPENSION SYSTEMS AND SHOCK ABSORBERS

7929 Lincoln Ave. Riverside, CA 92504 Phone: 951.689.ICON Fax: 951.689.1016
www.iconvehicledynamics.com



FOLLOW US ON FACEBOOK!

