







**Full-Race Intercooler (CAC) Install:
2017+ Raptor and 2015+ F-150 EcoBoost 3.5L**

Bill of Materials:

<p>P0244A-A</p>  <p><i>18-8 Stainless Steel Socket Head Screw - F150 EBOV</i></p>	<p>FR-UNI-SIL-2.5</p>  <p><i>2.5" Straight Silicone Coupler - Black</i></p>	<p>FR-UNI-TBC-2.5</p>  <p><i>2.5" T-Bolt Clamp</i></p>
<p>Quantity: 1</p>	<p>Quantity: 2</p>	<p>Quantity: 2</p>
<p>2015 F150 COMPLETE BUMPER BEAM</p>  <p><i>2015 + Ford F150 / Raptor Bumper Beam</i></p>	<p>FR-P0144A</p>  <p><i>2015+ F150 Intercooler Bracket</i></p>	<p>FR-UNI-SIL-3-45</p>  <p><i>3" 45 Degree Silicone Coupler - Black w/ Full Race Logo</i></p>
<p>Quantity: 1</p>	<p>Quantity: 1</p>	<p>Quantity: 2</p>
<p>FR-UNI-SIL-3</p>  <p><i>3" Straight Silicone Coupler - Black w/ Full Race Logo</i></p>	<p>FR-UNI-SIL-3.0H</p>  <p><i>3.0" Straight Silicone Hump Coupler - Black w/ Full Race Logo</i></p>	<p>FR-UNI-TBC-3</p>  <p><i>3.0" T-Bolt Clamp</i></p>
<p>Quantity: 1</p>	<p>Quantity: 1</p>	<p>Quantity: 8</p>

<p>P0323A-A</p>  <p><i>Black 5/16" Washer - F150 Bumper Beam</i></p>	<p>P0252A-A</p>  <p><i>Black-Oxide Alloy Steel Socket Head Screw - M8 x 1.25 mm Thread, 30 mm Long</i></p>	<p>P0242A-A</p>  <p><i>Black-Oxide Alloy Steel Socket Head Screw. M6 x 1 mm Thread, 18 mm Long</i></p>
<p>Quantity: 2</p>	<p>Quantity: 2</p>	<p>Quantity: 1</p>
<p>P0251A-A</p>  <p><i>2015+ F150 Cast Y-Pipe</i></p>	<p>P0243A-A</p>  <p><i>Chemical-Resistant Push-on Round Cap - F150 CAC</i></p>	<p>8096</p>  <p><i>F150 Intercooler Assembly</i></p>
<p>Quantity: 1</p>	<p>Quantity: 1</p>	<p>Quantity: 1</p>
<p>FR-RAP-EBOV-W</p>  <p><i>F150 Raptor eBOV Charge Pipe</i></p>	<p>FR-RAP-TB-W</p>  <p><i>F150 Raptor Throttle Body Charge Pipe</i></p>	<p>P0245A-A</p>  <p><i>Flat Washer - SS M4</i></p>
<p>Quantity: 1</p>	<p>Quantity: 1</p>	<p>Quantity: 1</p>

FR-UNI-TBC-2.5



2.65" T-Bolt Clamp

Quantity: 2

Required Tools:

- Trim Panel Removal Tool
- Flathead and Phillips screwdriver
- Needle Nose Pliers
- 3/8" Ratchet w/ 12" extension
- 7mm, 8mm, 10mm, 11mm, 13mm, 15mm Shallow and Deep Sockets
- 8mm, 10mm and 13mm Gear-Wrenches (Especially the 8mm)
- T27 Torx Bit – E6 External Torx Socket (if relocating adaptive cruise module)
- 3mm and 5mm Allen Wrench/Socket
- Dremel Cutoff Tool or Reciprocating air saw (to remove shutters)
- Masking Tape
- Sharpie or Paint Marker

Note: While the front end is apart for IC installation, now is an excellent opportunity to upgrade the transmission cooler and radiator at the same time.

Installation Procedure:

Step 1. Prepare your workspace.

Park the vehicle on level ground and set E-brake. Open the hood and disconnect the negative battery terminal. Avoid using every engine bay surface as a tool shelf (this can lead to leaving behind foreign objects that get sucked into your engine).



Step 2. Remove the grill:

Gently use trim panel removal tool on retaining clips to avoid damage or scratches.

Save clips and hardware for reinstallation

Using the Trim tool, start by removing the 2 retaining clips at the airbox inlet.



Remove (7) clips holding the radiator air deflector. Gently pry the center up until it unlocks, then pull on the larger round base to remove.

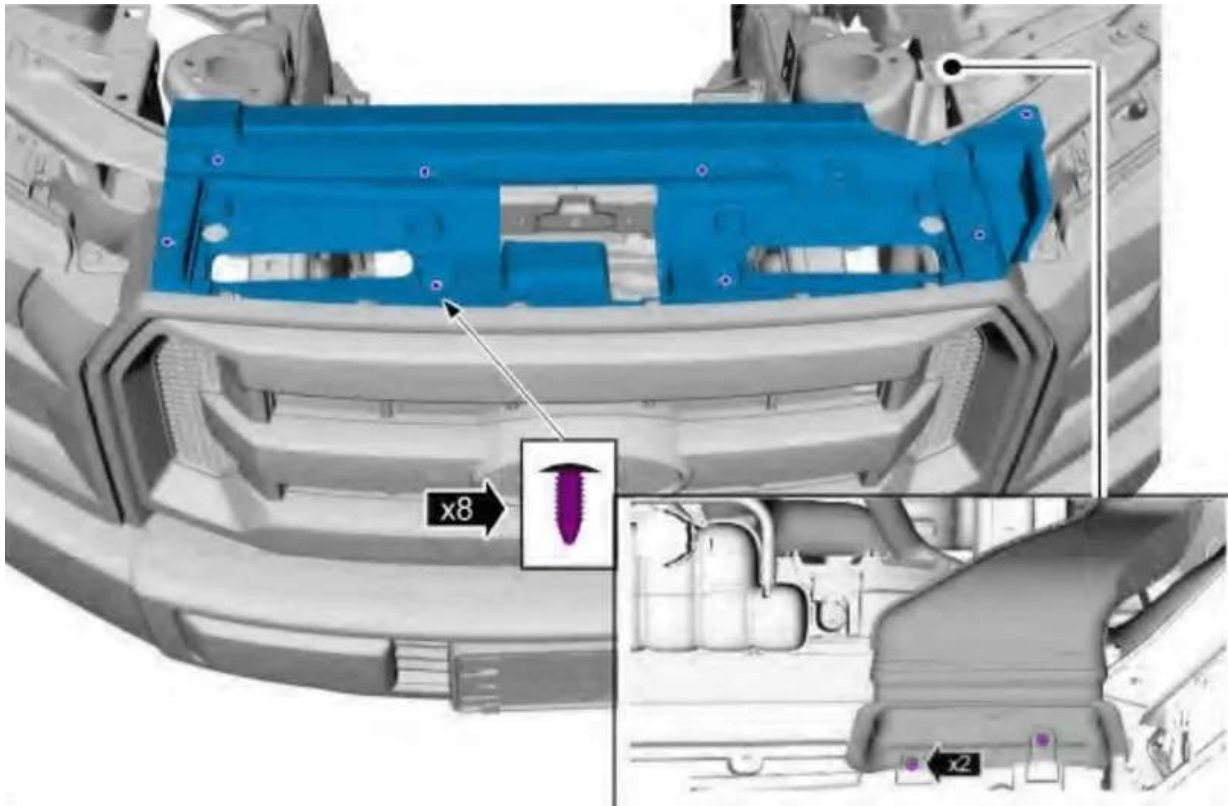



2021+ trucks have two additional trim clips on the corner of the core support, two small 7mm bolts on each of the passenger/driver side fender liners, and a corner lamp that needs unplugging.

Step 3. Using an 8mm socket, remove 4 bolts (17-20) or 2 bolts (21+) that hold the grille assembly to the core support. This may be a 10mm socket on early 2017 trucks.

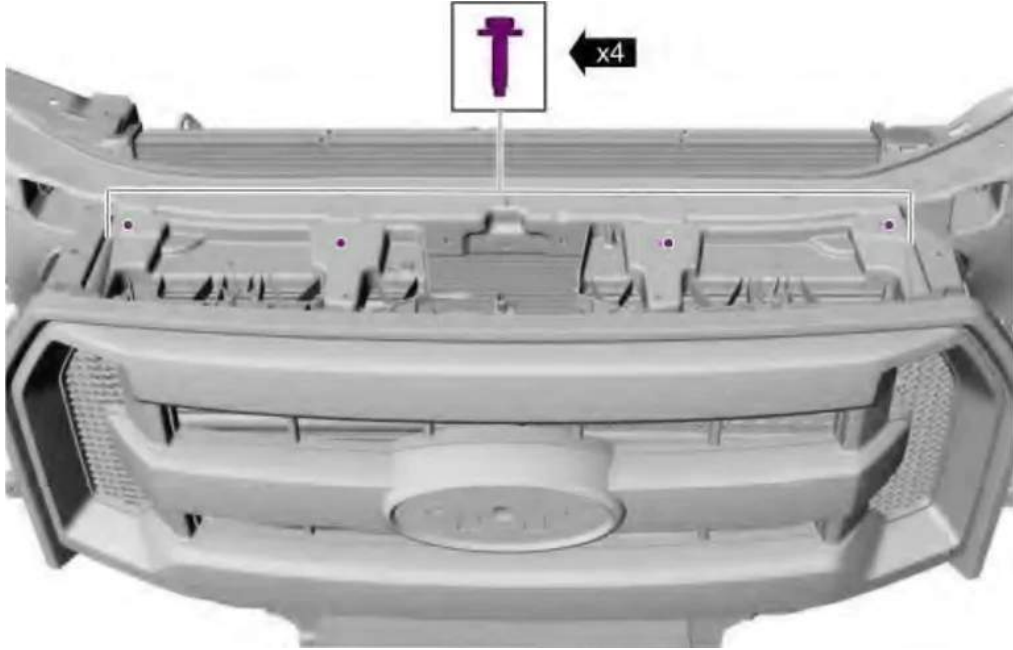

Step 4. Unplug the Grille shutters at the two electrical connectors and washer hose (gently spread the retainer ring on the washer line and unplug the hose). Unclip the grille harness plastic push-clip from grille.

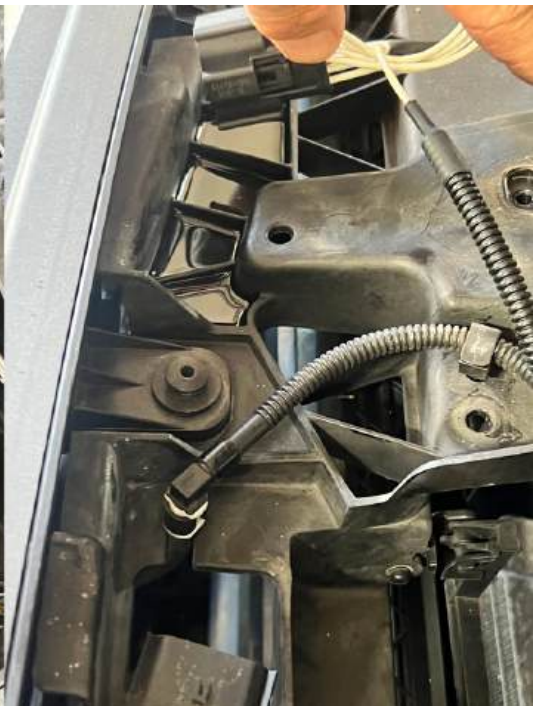
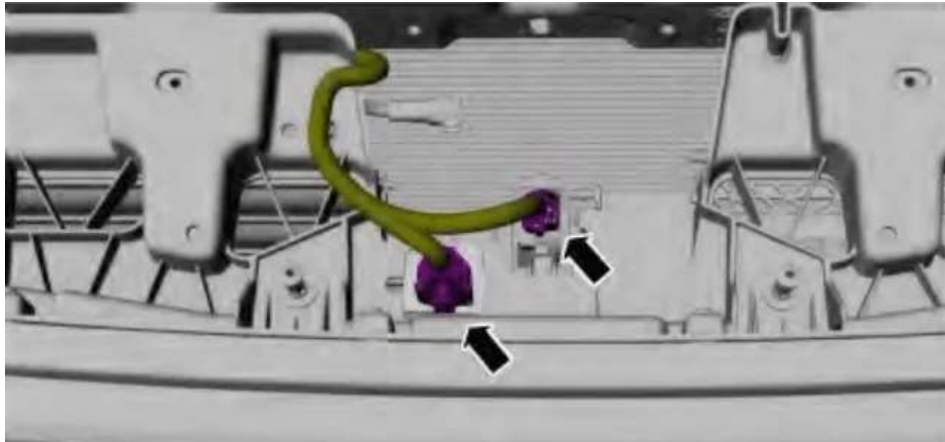

Step 5. Remove the headlamp assembly trim panel.

- Remove pin-type retainer from the top of headlight surround, one per side.
- Starting at the inner edge, release the headlamp assembly trim panel clips.
- Starting at the outer edge, release the headlamp assembly trim panel.

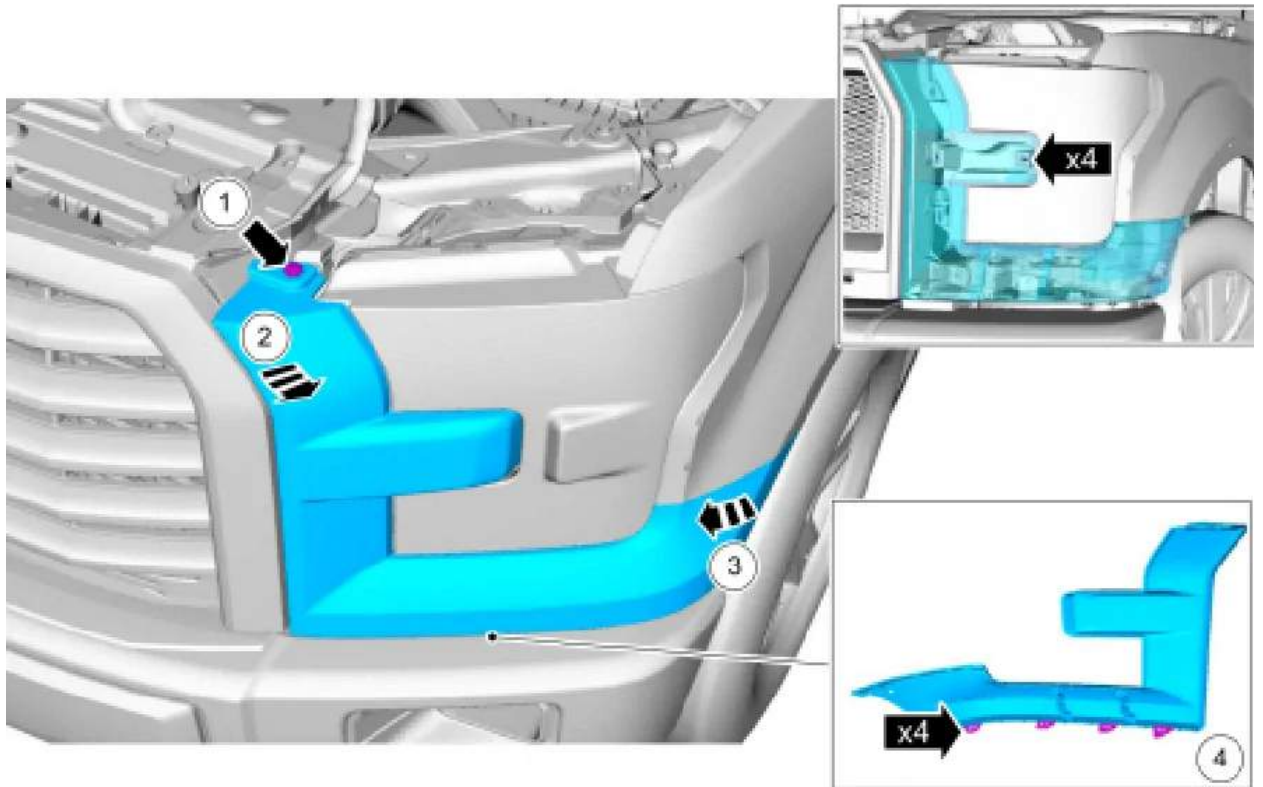

Step 6. Gently pry on headlight surrounds by hand only, starting from the side closest to the grill. They don't have to be removed entirely, but it will make grill removal and installation easier.



Step 7. Remove 3 christmas tree clips from each side of the grille assembly.



Step 8. Remove x2 8mm bolts from each lower corner of the grille using an extension and 8mm socket.



Step 9. Find a safe place to set the Grille. Carefully lift and remove grille assembly out of the vehicle. Avoid scratches/scrapes.

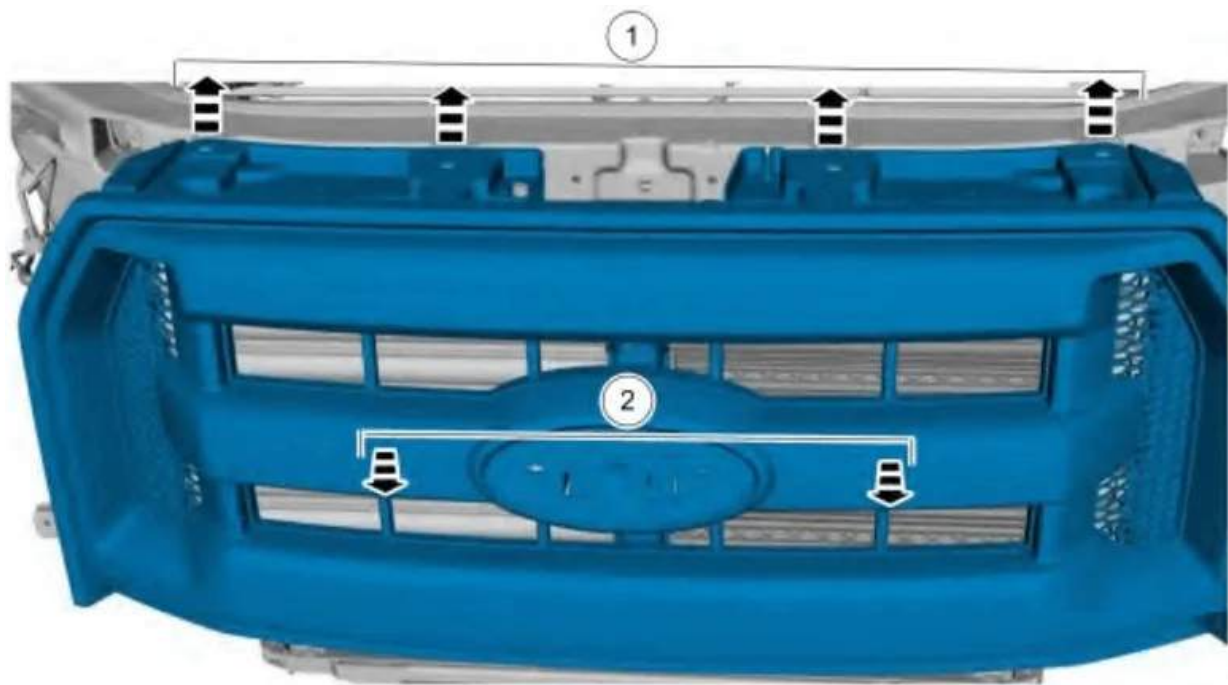

Step 10. Transmission Cooler hoses: Raptors, 2017 F-150, and Max-Tow F-150

Rotate the OEM bracket for the transmission cooler line (toward the radiator) to prevent rubbing -OR- OPTIONALLY: Right now is the perfect time to upgrade your transmission cooler!!

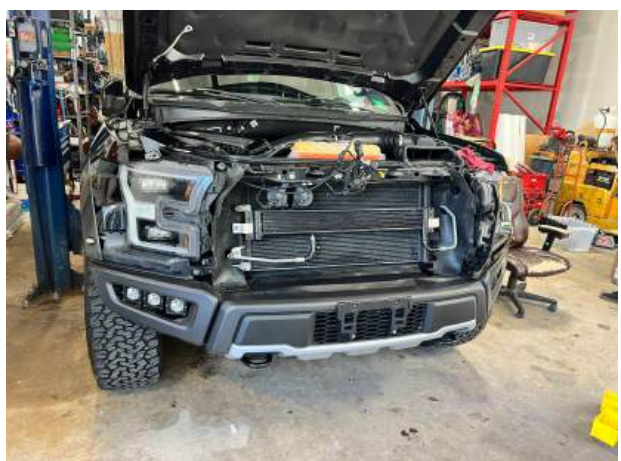
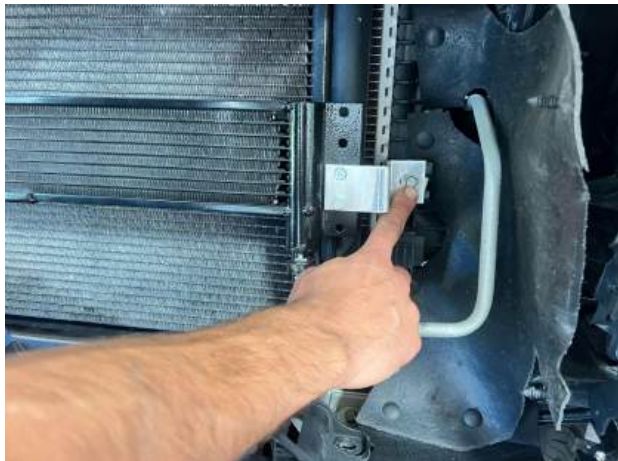
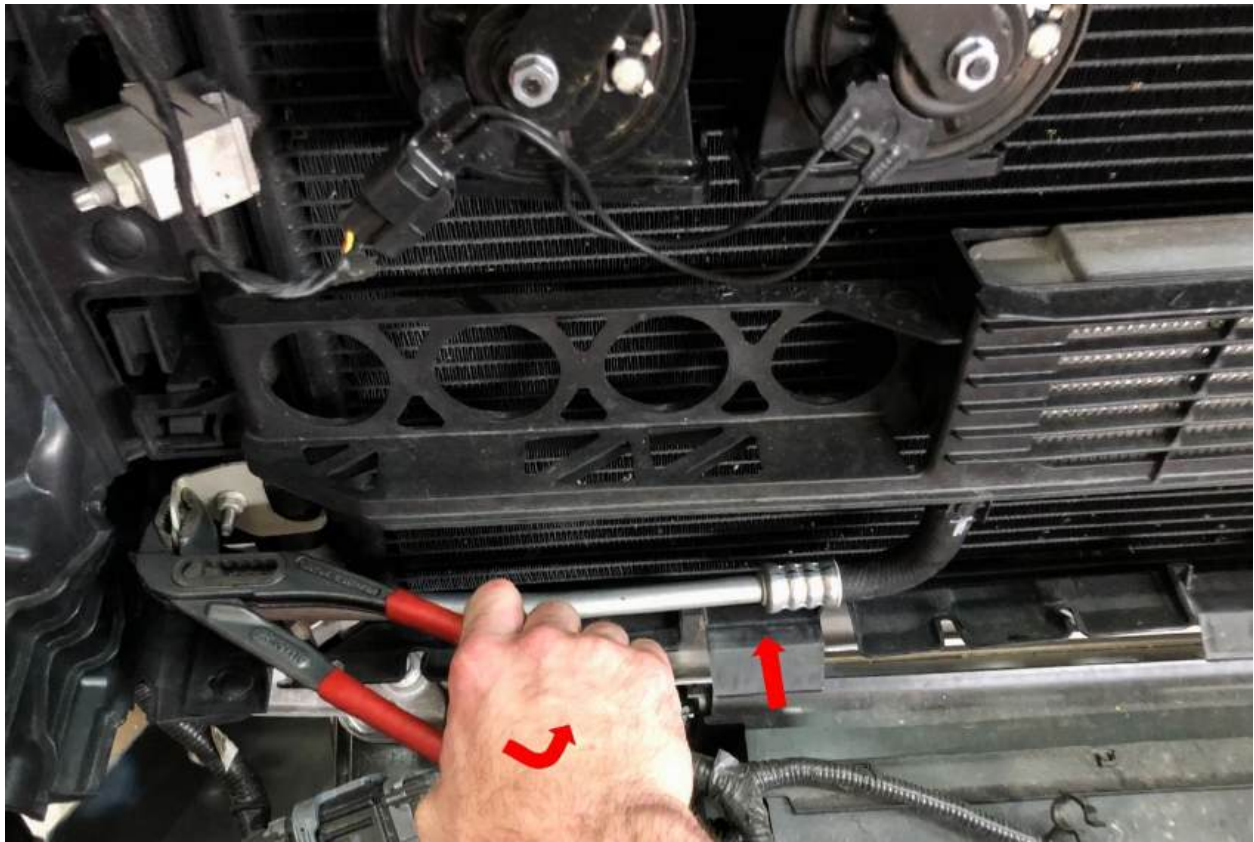



Step 11. Remove Skid plate: For Raptor, Tremor, FX4, and off-road packages

Use 13mm and 15mm sockets to remove the skid plate mounting bolts, then drop down the OEM skid plate.

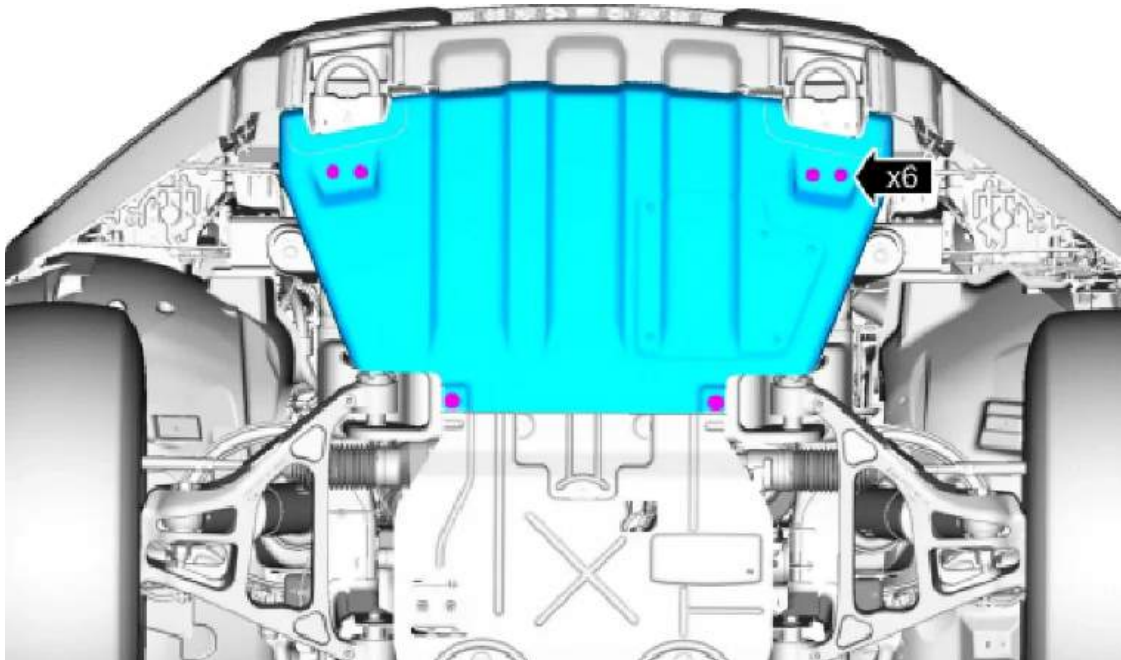



Step 12. Unplug electronic bypass valve connector. Then, for Raptors only, unplug OEM intercooler fan by squeezing the clip, then disconnecting. Using trim tool, disconnect the wiring harness from the fan.

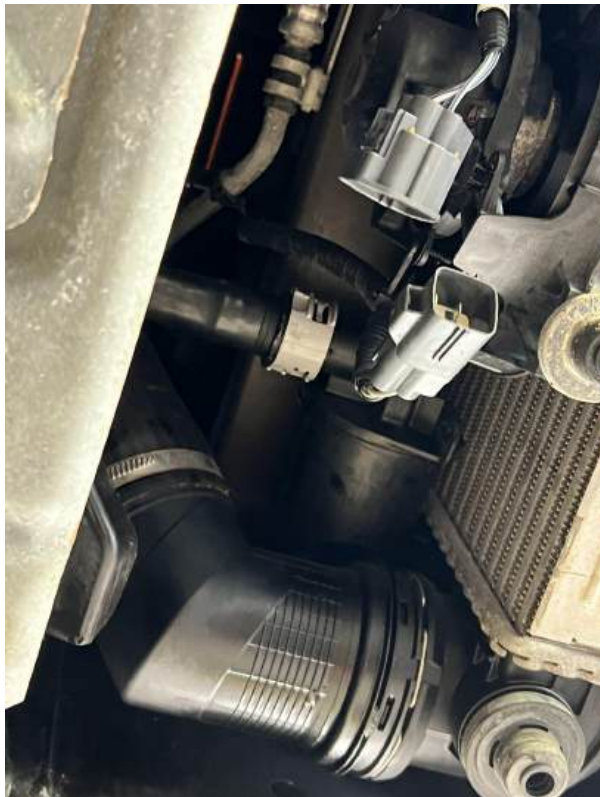

Step 13. Disconnect the electronic Bypass hose from the intake by turning the plastic connect counter-clockwise and wiggling (spray-lube helps). Unhook eBOV recirculation tube from Intake pipe.



Step 14. Using a screwdriver or 7mm socket (8mm on some trucks), loosen all three intercooler couplers from the OEM endtanks, then stretch/wiggle/separate the factory charge pipes from the intercooler.

Remove clip at intercooler cold side connection on driver side using a pick-tool or flat-head screwdriver.

Step 15. Unbolt OEM lower intercooler support and use trim tool to separate wiring connectors on the fan and intercooler. Your old factory intercooler and CAC cooling fan can now be removed from vehicle.

Note: Do not lose rubber intercooler isolator bushings – these will be reused!

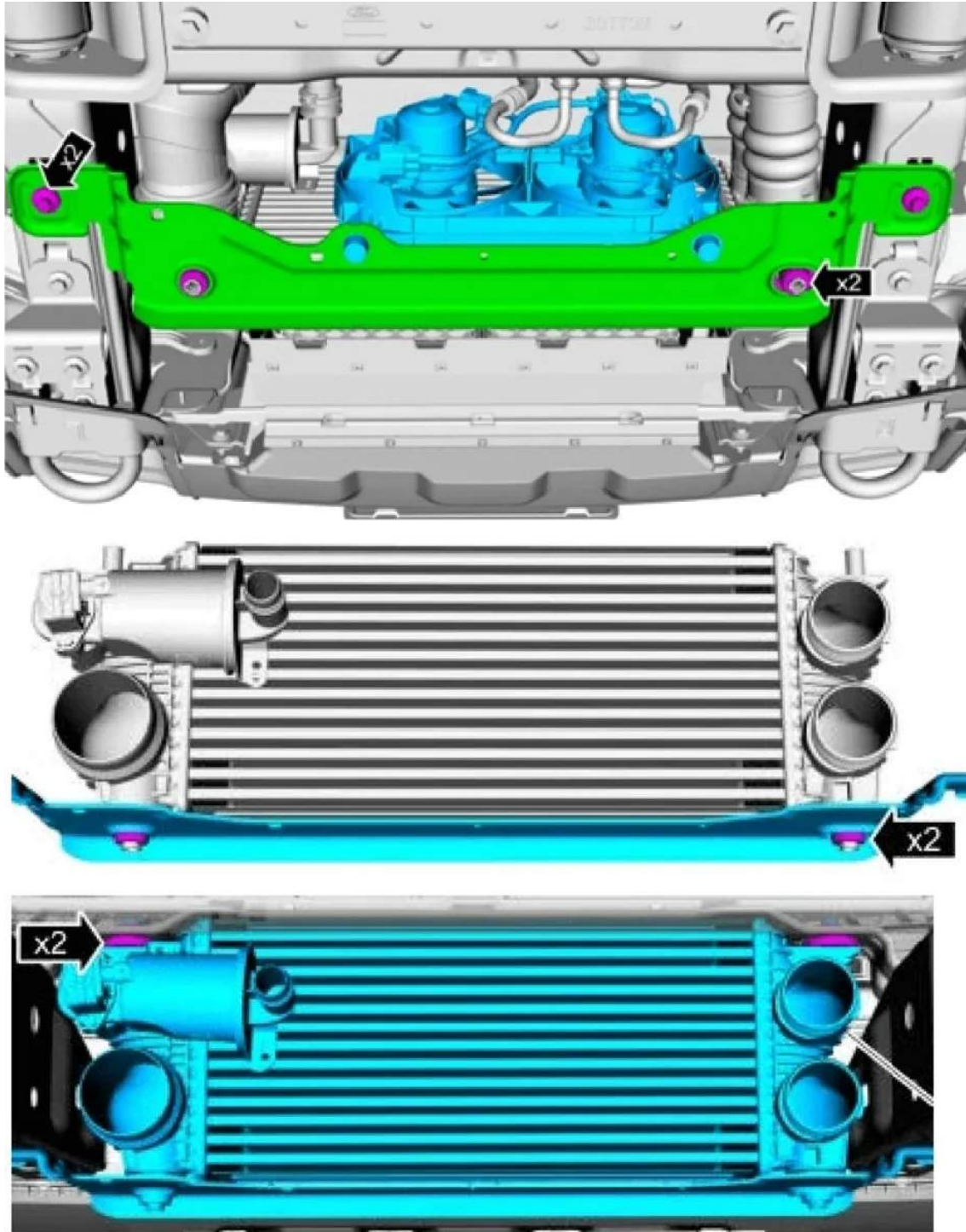

Step 16. Remove Intercooler Shutters and upper bracket

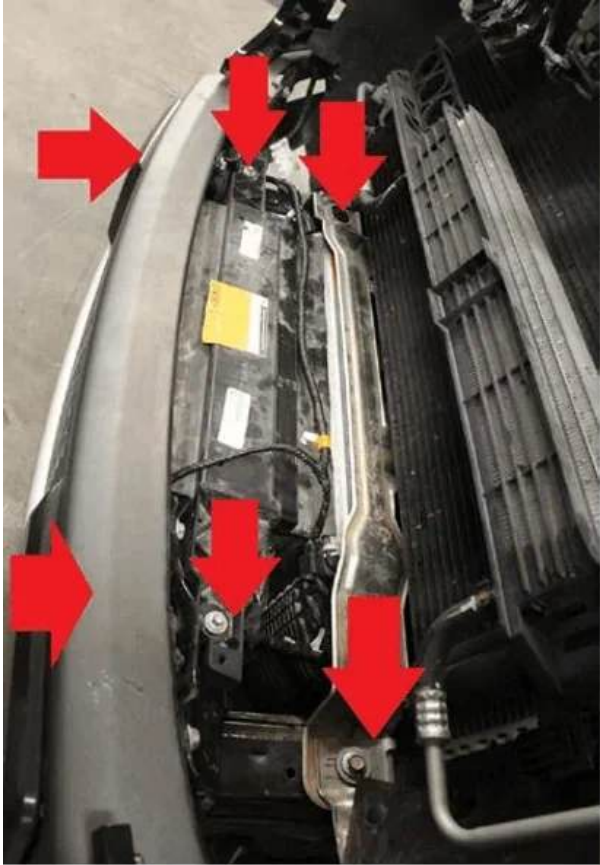

16a. Start with the shutters, separate the rubber cover and unplug the shutters motor

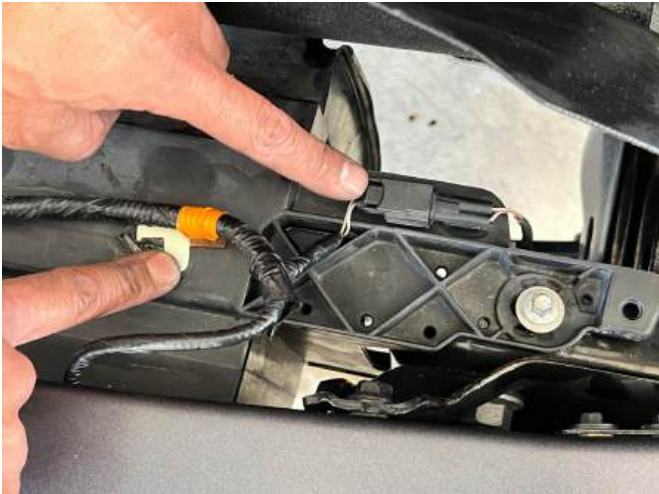
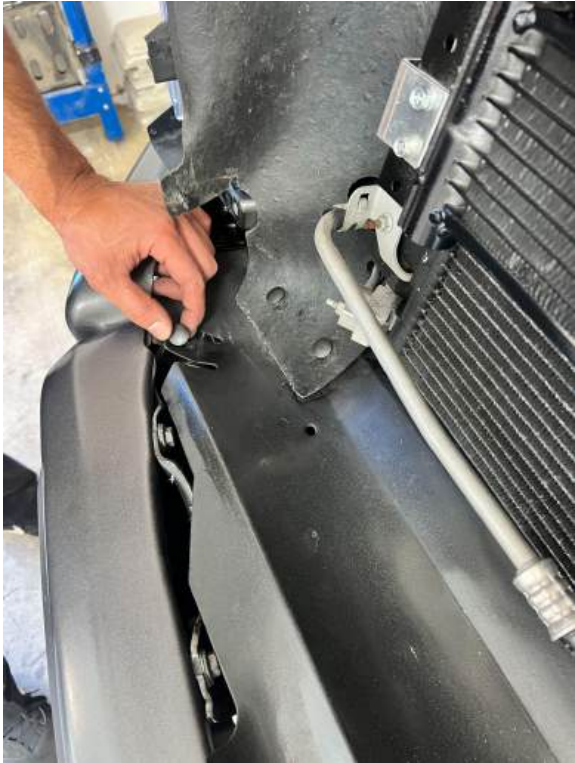



16b. Remove Metal Bracket from upper intercooler mount.





16c. Remove x2 8mm bolts on the top that go into the frame rail.



16d. Remove lower 8mm bolts - NOTE: a ratcheting 8mm gear wrench is a must! This tool will save a ton of time here.



16e. Extract the Intercooler Shutters Assembly

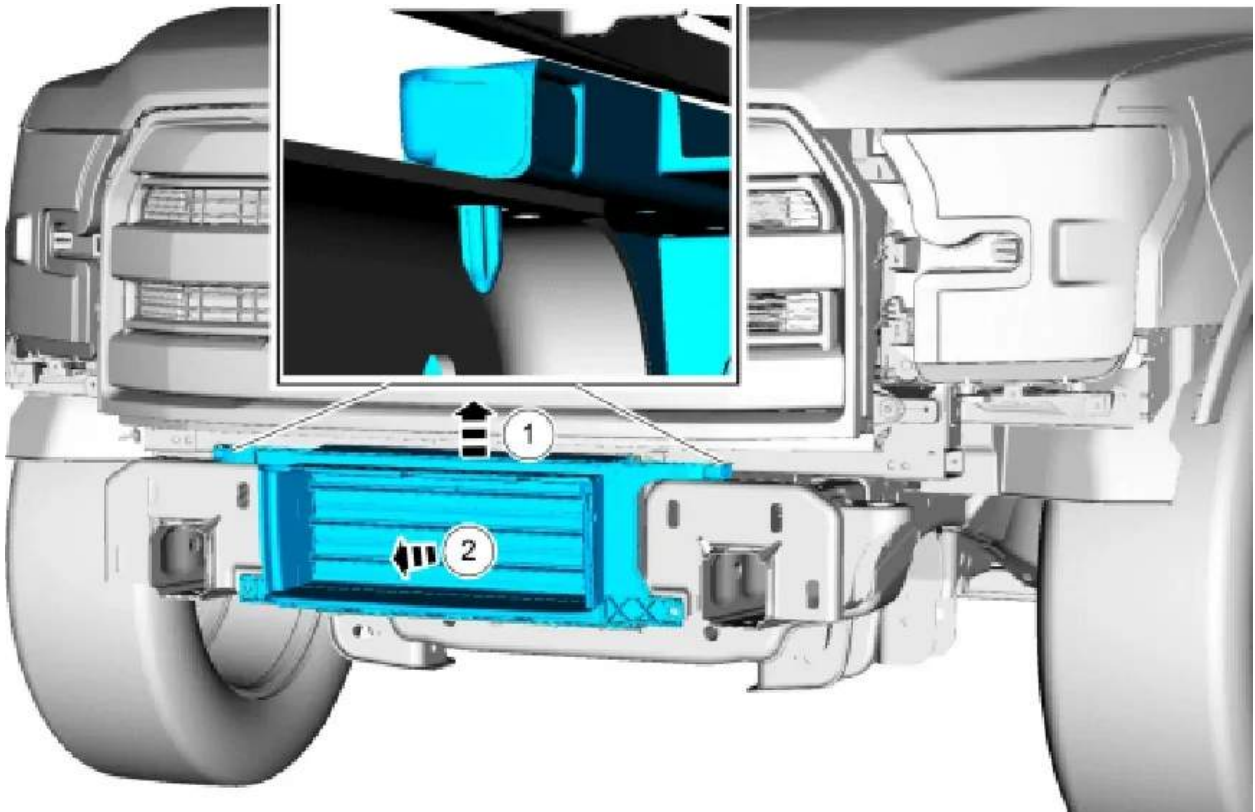

Step 17: Install Full-Race intercooler mounting beam in place of OEM intercooler mount – use Full-Race provided hardware and tighten.



Step 18. Test-fit Full-Race intercooler with isolator bushings on mounting beam.



Mark and Trim the lower plastic dirt shields using a razor blade and 4" holesaw (or remove it entirely)



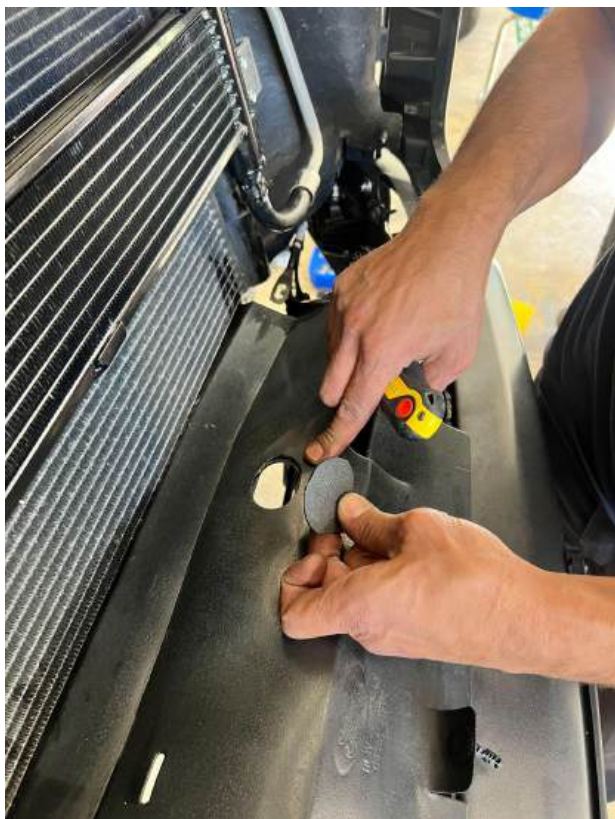
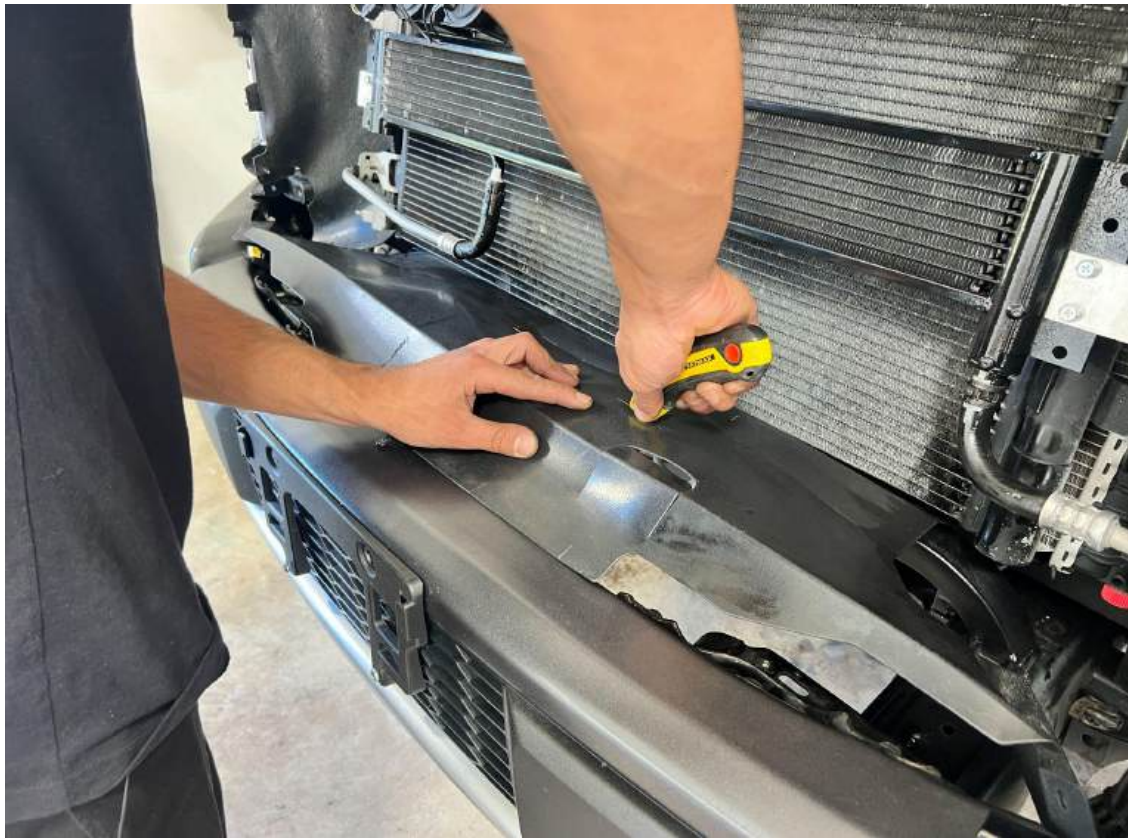

Step 19. Install Intercooler Core: Install all four factory rubber mounting isolator bushings from OEM intercooler onto Full-Race intercooler and place it in its new home.



Step 20. Install Upper Bracket in Front of Hood Latch: Remove bolts from hood latch, install included hood latch bracket onto Full-Race intercooler and bolt in place. Bolt bracket on top of / in front of latch - not behind/under it!

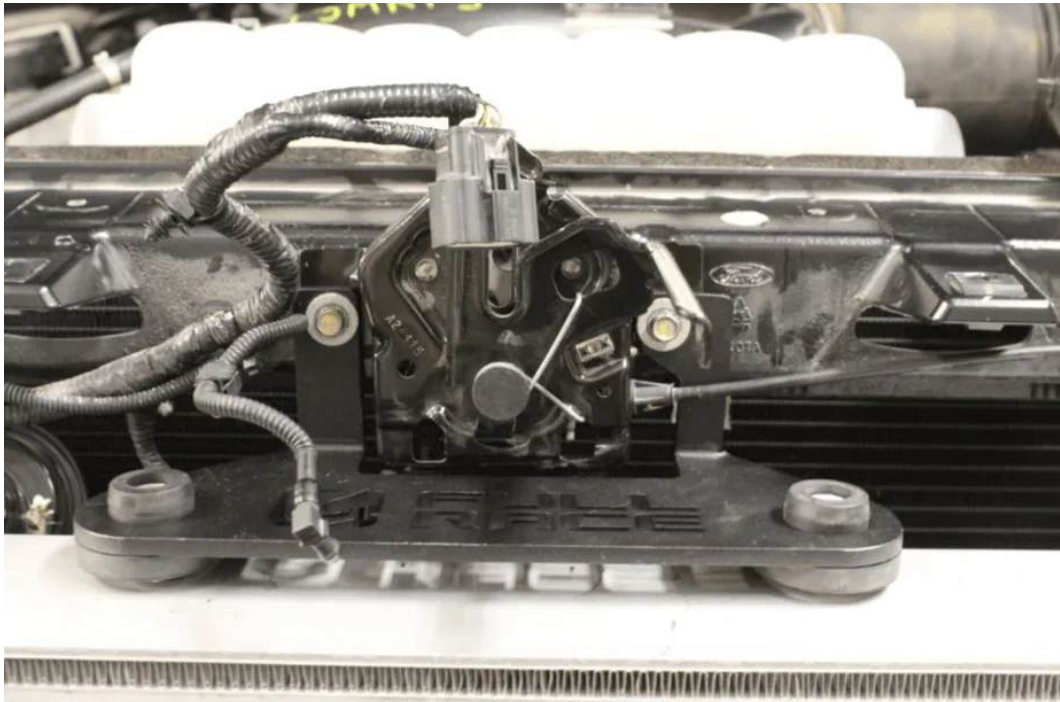

Step 21. Prepare Charge Piping: Remove plastic throttle body pipe from vehicle:

First, unplug IAT sensor after airbox. Using a 7mm socket, loosen clamps, remove Intake tube from airbox.

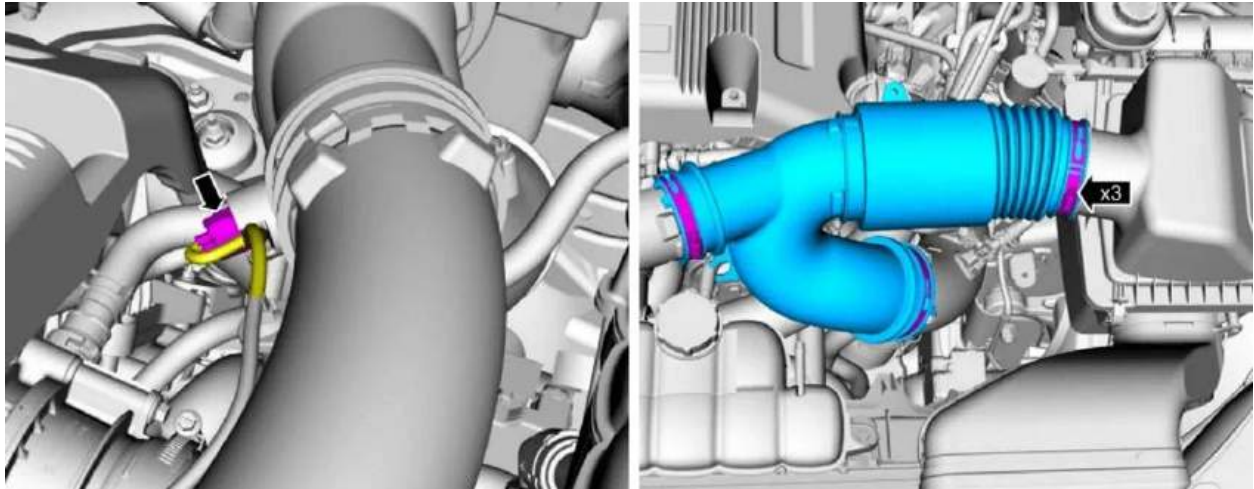

Next, unplug TIP sensor from factory throttle body pipe and unhook EVAP hose fitting. To disconnect the EVAP fitting pinch the two exposed tabs while pushing down on them. Loosen both clamps on the throttle body coupler. Remove plastic throttle body pipe from vehicle.

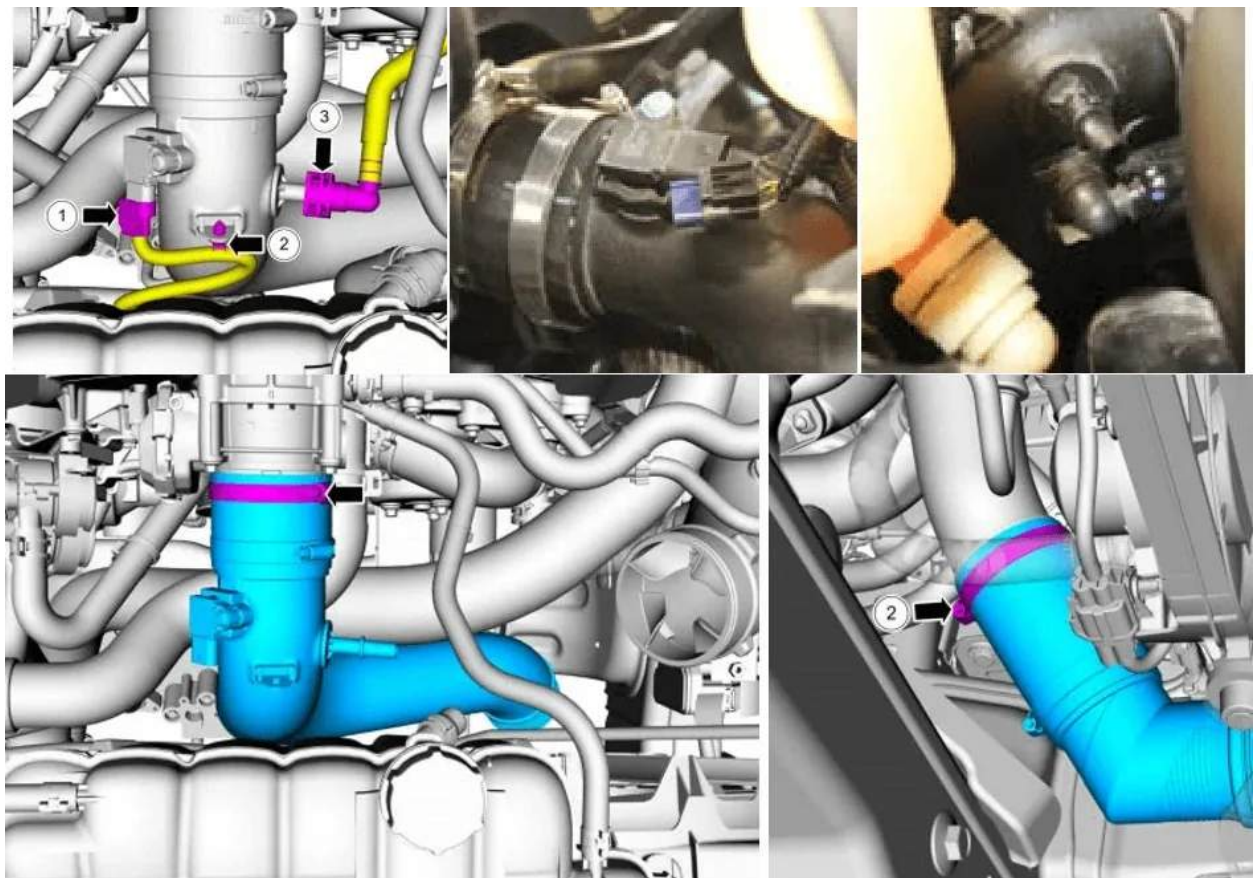

Step 22. Use 8mm socket to remove eBOV canister screw (#1) if the OEM eBOV will be reused.

(If using a Turbosmart eBOV, you can skip to step 23.)

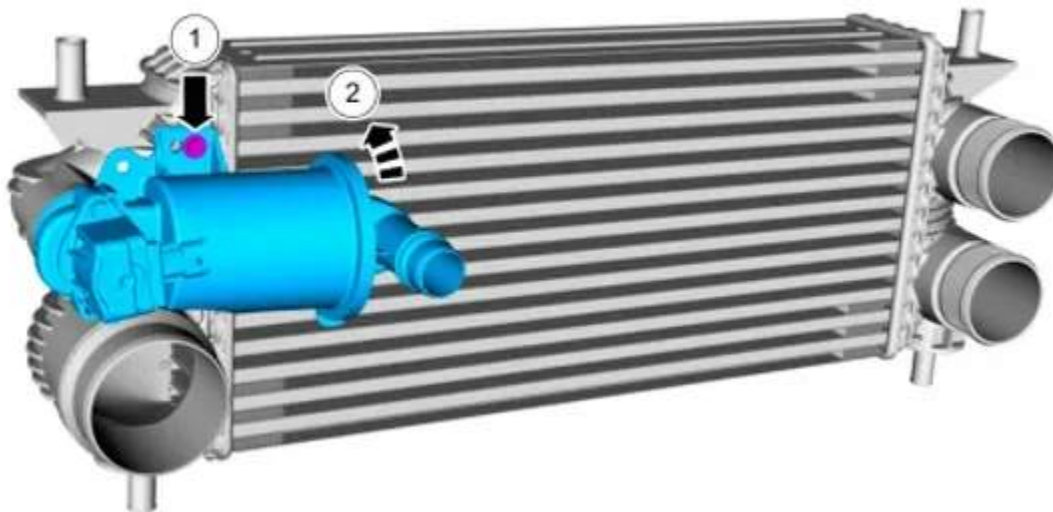

Step 23. Install TIP Sensor: Using a T27 Torx bit, remove TIP sensor from plastic OEM Throttle Body pipe. Reinstall sensor to new throttle body pipe with supplied screw.



Step 24. Apply lube to eBOV oring, install eBOV valve on the new cold side charge pipe. Use the turbosmart -OR- transfer your factory electronic BOV from the factory intercooler over to the BOV charge pipe. Use supplied bolt to fasten BOV to new pipe. Plug in EBOV once installed in vehicle.



Step 25. Install Throttle Body charge pipe, and E-BOV pipe. Loosely install 3" straight coupler and two 3" T-bolt clamps to throttle body. Install throttle body pipe into truck. Install the supplied 3" hump coupler over the other end of throttle body pipe

along with a 3" T-bolt clamp. Install intercooler outlet pipe. Double-check to align everything until happy with fitment.



Step 26. Install supplied 2.5" couplers and T-bolt clamps onto factory hot pipes on passenger side of truck – these are the ones that had the blue couplers on them. Then install the supplied Y-pipe on the passenger side of the truck. Do not fully tighten yet.



Install 3" 45 couplers and T-bolt clamps onto the supplied Y-pipe and BOV pipe.

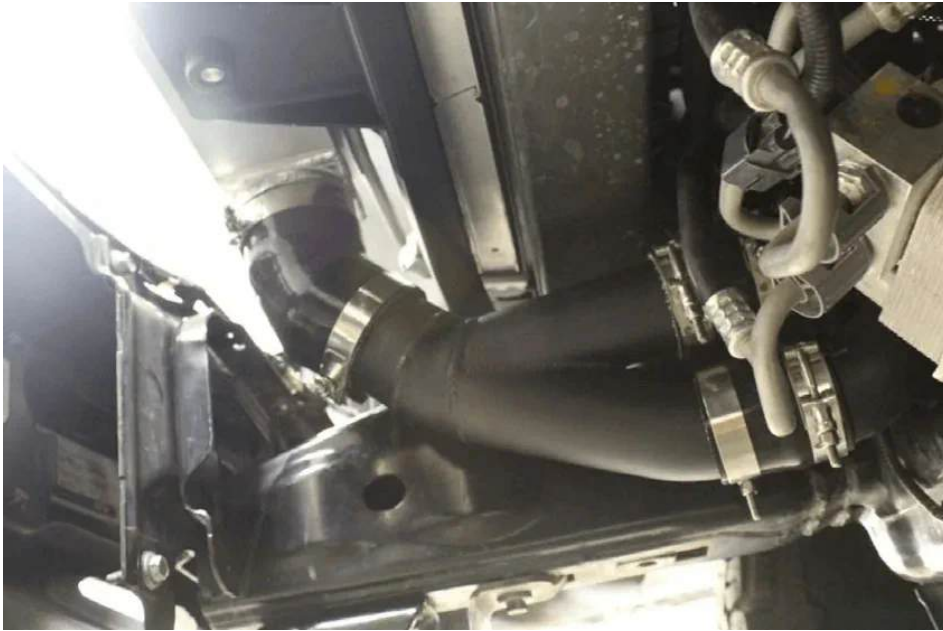

Step 27. At this point, the charge piping is loosely connected and ready for final assembly. Double-check all couplers and clamps are fully seated behind the beadroll. Once all charge pipes are oriented, tighten all T-bolt clamps to 44lb.in / 5Nm. Double-check check you did not miss any.

Note: Do not overtighten clamps! T-bolts can crush charge pipes



Step 28. Remove Shutters from Factory Grille: Now that Intercooler is firmly mounted in the truck and charge pipes are fastened, we must remove the OEM shutter system from the factory grille. This increases engine cooling and provides clearance for the oversized intercooler.



Using some muscle and pliers (or your hands) Start by removing the outer post from its hole by bending the plastic shutter until there is enough clearance to release the peg. Then, rotate the shutter toward the front of grill to release inner post

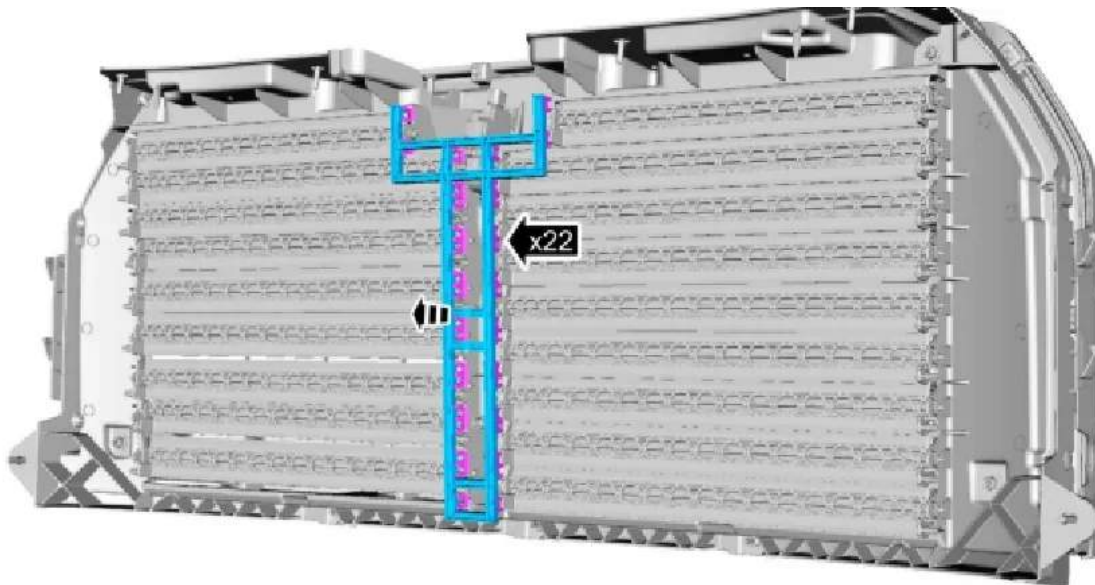

There are x4 pop-up clips on the top of the grille, x4 nuts on the backside, and a lone bolt in the middle of the shutter system on the backside.

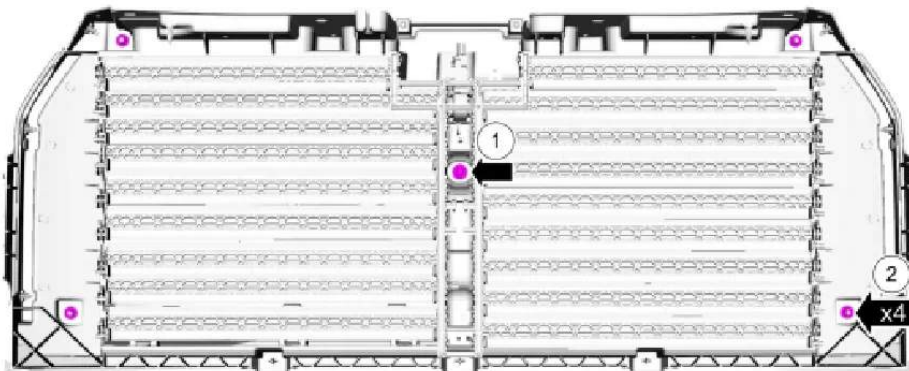
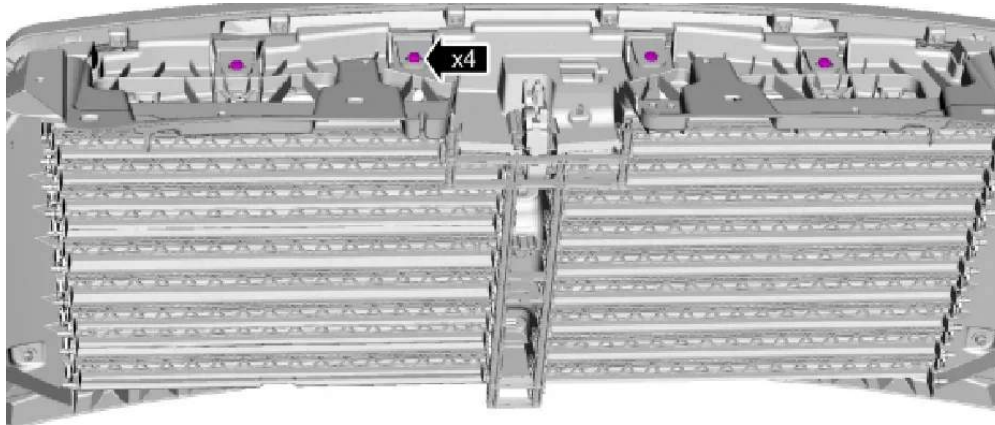

Step 29. Remove the motor for the shutter system, leaving plugged in and zip tie to the side to avoid any error lights.

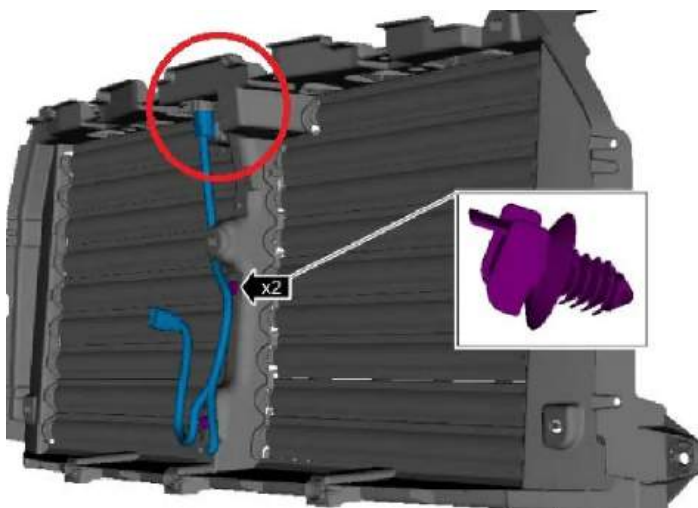

Step 30. Pry the shutters out of the grille backing one by one with a pry tool, then remove the motor by prying the clip away from the support. Lay down some masking tape for your trim lines.

Note: You want to keep the post on the bottom tall enough so you can remount the ambient air temp sensor.

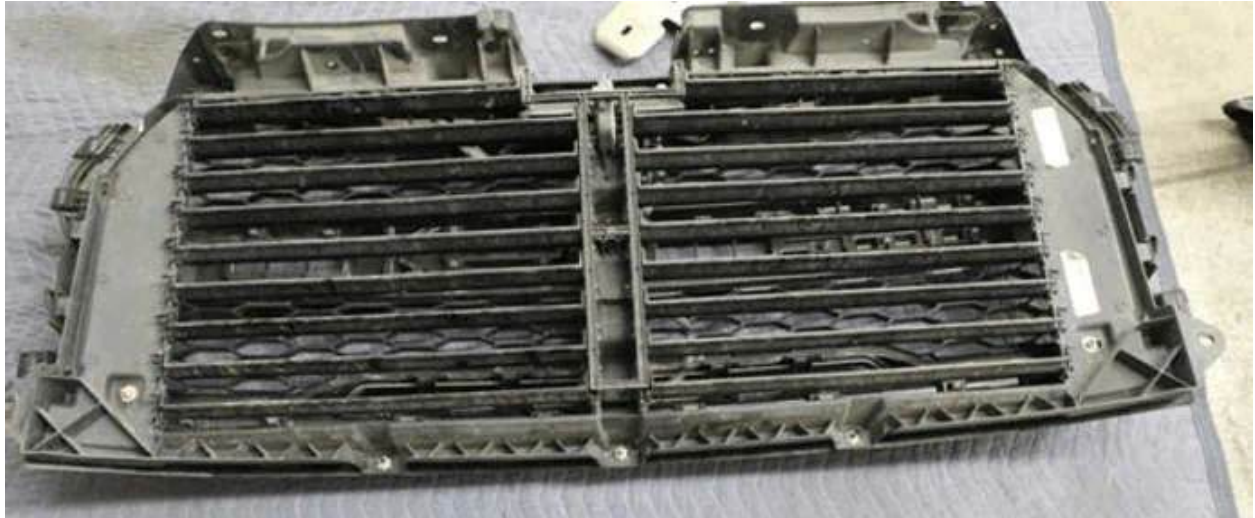

Reference the photo below for how much to trim. You will cut an inch out of the bottom so this piece can fit around the new intercooler.





Step 31. Now is a great time to let the world know that you're running the best intercooler system available. Use rubbing alcohol and some scotch bright on the core. Apply masking tape and the Full-Race supplied spray-paint stencil positioned on the 5th row (See photo) and use your favorite High-Temp paint (BBQ paint works great!). Rubbing Alcohol and Scotchbright make sure it adheres.



Step 32. For 2018+ be sure to reinstall the ambient air temp sensor at the base of the trimmed plastic (2017 not applicable).



Step 33. Reinstall grille onto trimmed piece using the OEM hardware, minus the center bolt.

Step 34. Double check that everything is tight, secure and plugged in. Reinstall grille assembly in reverse order of disassembly. Be sure to plug in all connections by the hood latch. Go over all work, ensure there is nothing overtightened or loose/disconnected before reinstalling grille, skid plate, grille, headlight surrounds, and plastic front bumper pieces.





Step 35. OPTIONAL: To recirculate the eBOV bypass air, connect AC Delco 26309X tube (not included) to eBOV quick disconnects: Remove factory E-BOV recirculation line from the bottom of the intake tube. Separate the plastic quick disconnect fittings. Using 1" heater hose, AC Delco 26309X extend to intake tube. (Credit to Paul Haskew for finding the perfect hose that fits without cutting).

If not recirculating, use rubber cap to seal the intake barb. If using an aftermarket mechanical BOV (like TiAl in place of oem eBOV, make sure to plug in the eBOV and zip tie it off to the side.



